



## Department of Energy

Portsmouth/Paducah Project Office  
1017 Majestic Drive, Suite 200  
Lexington, Kentucky 40513  
(859) 219-4000

**APR 12 2017**

Mr. Brian Begley  
Federal Facility Agreement Manager  
Division of Waste Management  
Kentucky Department for Environmental Protection  
300 Sower Boulevard, 2nd Floor  
Frankfort, Kentucky 40601

PPPO-02-4069956-17

Ms. Julie Corkran  
Federal Facility Agreement Manager  
U.S. Environmental Protection Agency, Region 4  
61 Forsyth Street  
Atlanta, Georgia 30303

Dear Mr. Begley and Ms. Corkran:

**TRANSMITTAL OF THE ADDENDUM TO THE REMEDIAL INVESTIGATION REPORT FOR THE BURIAL GROUNDS OPERABLE UNIT SOLID WASTE MANAGEMENT UNIT 4 AT THE PADUCAH GASEOUS DIFFUSION PLANT, PADUCAH, KENTUCKY (DOE/LX-07-0030&D2/R1/A1/R2)**

References:

1. E-mail from B. Begley to D. Dollins, "Final Language for SWMU 4 RI Report Addendum from the Condition Resolution Meeting," dated March 30, 2017
2. E-mail from J. Richards to D. Dollins, "Final Language for SWMU 4 RI Report Addendum from the Condition Resolution Meeting," dated March 29, 2017
3. Letter from J. Richards to T. Duncan, "EPA Conditional Concurrence: *Addendum to the Remedial Investigation Report for the Burial Grounds Operable Unit Solid Waste Management Unit 4 at the Paducah Gaseous Diffusion Plant*, Paducah, Kentucky (DOE/LX/07-0030&D2/R1/A1/R1), transmittal dated January 27, 2017, (PPPO-02-3969409-17), U.S. EPA ID KY8890008982," dated February 28, 2017
4. Letter from A. Webb to T. Duncan, "Conditional Concurrence with the Addendum to the Remedial Investigation Report for the Burial Grounds Operable Unit SWMU 4 (DOE/LX/07-0030&D2/R1/A1/R1), Paducah Site, Paducah, McCracken County, Kentucky, KY8-890-008-982," dated February 27, 2017

Please find enclosed for your approval the certified *Addendum to the Remedial Investigation Report for the Burial Grounds Operable Unit Solid Waste Management Unit 4 at the Paducah Gaseous Diffusion Plant, Paducah, Kentucky*, DOE/LX/07-0030&D2/R1/A1/R2 (Addendum). This version of the Addendum addresses conditions received from the U.S. Environmental Protection Agency (EPA) and the Kentucky Department for Environmental Protection (KDEP) in the referenced letters and reflects results of associated discussions held among the Federal Facility Agreement (FFA) parties on March 27, 2017 and March 28, 2017. To assist with the review, a redline version of the document and two condition response summaries are enclosed.

When addressing EPA and KDEP conditions, changes were made to the Executive Summary, Section 1.3.2, Section 7 and to associated references. The U.S. Department of Energy (DOE) made no other changes to the D2 Addendum that had been submitted on January 27, 2017.

Based on the e-mails received from EPA and KDEP on March 29, 2017 and March 30, 2017, respectively, and the cooperative effort by all parties to resolve the conditions, the changes made in this submittal satisfy all conditions. In the event that EPA and/or KDEP determines that the conditions have not been satisfied, DOE reserves its right to dispute in accordance with Section XXV.A of the FFA.

DOE appreciates the FFA parties' efforts in resolving conditions and looks forward to receiving approval of the Addendum.

If you have any questions or require additional information, please contact Dave Dollins at (270) 441-6819.

Sincerely,

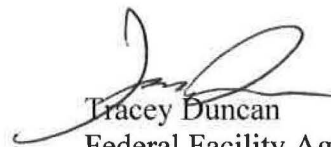

Tracey Duncan  
Federal Facility Agreement Manager  
Portsmouth/Paducah Project Office

Enclosures:

1. SWMU 4 RI Report Addendum DOE/LX/07-0030&D2/R1/A1/R2—clean
2. SWMU 4 RI Report Addendum DOE/LX/07-0030&D2/R1/A1/R2—redline
3. Condition Response Summary—EPA
4. Condition Response Summary—KDEP
5. Certification Page

e-copy w/enclosure:

april.webb@ky.gov, KDEP/Frankfort  
brian.begley@ky.gov, KDEP/Frankfort  
bwhatton@tva.gov, TVA/Paducah  
christopher.jung@ky.gov, KDEP/Frankfort  
corkran.julie@epa.gov, EPA/Atlanta  
edward.winner@ky.gov, KDEP/Frankfort  
ffscorrespondence@ffspaducah.com, FFS/Kevil  
gaye.brewer@ky.gov, KDEP/PAD  
hjlawrence@tva.gov, TVA/Paducah  
jennifer.woodard@lex.doe.gov, PPPO/PAD  
karen.walker@ffspaducah.com, FFS/Kevil

kim.knerr@lex.doe.gov, PPPO/PAD  
lbirk@techlawinc.com, EPA/Chicago  
leo.williamson@ky.gov, KDEP/Frankfort  
mike.guffey@ky.gov, KDEP/Frankfort  
myrna.redfield@ffspaducah.com, FFS/Kevil  
nathan.garner@ky.gov, KYRHB/Frankfort  
pad.rmc@swiftstaley.com, SSI/Kevil  
richards.jon@epamail.epa.gov, EPA/Atlanta  
rkdehart@tva.gov, TVA/Paducah  
stephaniec.brock@ky.gov, KYRHB/Frankfort  
tracey.duncan@lex.doe.gov, PPPO/PAD

DOE/LX/07-0030&D2/R1/A1/R2  
Primary Document

**Addendum to the Remedial Investigation Report  
for the Burial Grounds Operable Unit  
Solid Waste Management Unit 4  
at the Paducah Gaseous Diffusion Plant,  
Paducah, Kentucky**

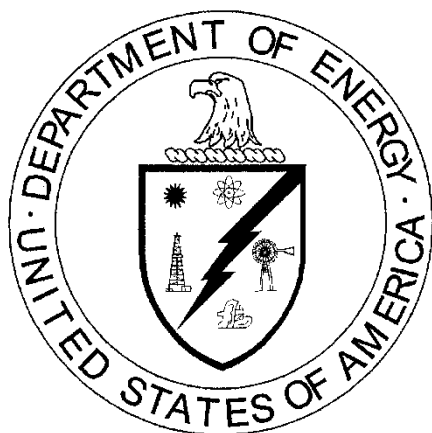

**CLEARED FOR PUBLIC RELEASE**



**Addendum to the Remedial Investigation Report  
for the Burial Grounds Operable Unit  
Solid Waste Management Unit 4  
at the Paducah Gaseous Diffusion Plant,  
Paducah, Kentucky**

Date Issued—April 2017

U.S. DEPARTMENT OF ENERGY  
Office of Environmental Management

Prepared by  
FLUOR FEDERAL SERVICES, INC.,  
Paducah Deactivation Project  
managing the  
Deactivation Project at the  
Paducah Gaseous Diffusion Plant  
under Task Order DE-DT0007774

**CLEARED FOR PUBLIC RELEASE**

**THIS PAGE INTENTIONALLY LEFT BLANK**

# CONTENTS

TABLES .....	v
FIGURES .....	vii
ACRONYMS .....	ix
EXECUTIVE SUMMARY .....	ES-1
1. INTRODUCTION .....	1-1
1.1 PURPOSE OF ADDENDUM REPORT .....	1-1
1.2 PROJECT SCOPE AND RATIONALE .....	1-1
1.3 SWMU 4 BACKGROUND .....	1-5
1.3.1 Site Description .....	1-5
1.3.2 Site History .....	1-5
1.3.3 Investigation History .....	1-7
1.4 ADDENDUM REPORT ORGANIZATION .....	1-13
2. STUDY AREA INVESTIGATION .....	2-1
2.1 PHASED INVESTIGATIONS .....	2-1
2.1.1 Phase I .....	2-1
2.1.2 Phase II .....	2-3
2.1.3 Phase III .....	2-7
2.1.4 Phase IV .....	2-7
2.1.5 Phase V .....	2-9
2.2 ENGINEERING AND DESIGN INFORMATION .....	2-9
2.3 DEVIATIONS .....	2-10
2.4 QUALITY ASSURANCE/QUALITY CONTROL .....	2-12
2.4.1 Field QC .....	2-12
2.4.2 Laboratory QC .....	2-13
2.4.3 Data Management QC .....	2-15
3. PHYSICAL CHARACTERISTICS OF THE STUDY AREA .....	3-1
3.1 SOIL AND GROUNDWATER PROPERTIES .....	3-1
3.2 SWMU 4 HYDROGEOLOGIC INTERPRETATION .....	3-2
3.2.1 SWMU 4 Hydrogeologic Conceptual Model .....	3-7
4. NATURE AND EXTENT OF CONTAMINATION .....	4-1
4.1 DATA PROCESSING AND SCREENING .....	4-1
4.2 SURFACE SOILS .....	4-2
4.3 SUBSURFACE SOILS .....	4-17
4.4 GROUNDWATER .....	4-70
4.4.1 Upper Continental Recharge System .....	4-70
4.4.2 Regional Gravel Aquifer .....	4-74
4.4.3 McNairy Formation .....	4-74
4.4.4 Potential Trichloroethene Dense Nonaqueous-Phase Liquid .....	4-80
5. FATE AND TRANSPORT .....	5-1
5.1 CONCEPTUAL MODEL .....	5-1

5.2	FATE AND TRANSPORT MODELING SUMMARY .....	5-1
5.3	GROUNDWATER PROTECTION SCREENING SUMMARY .....	5-2
6.	HUMAN HEALTH RISK EVALUATION AND ECOLOGICAL RISK SCREENING .....	6-1
6.1	BGOU SWMU 4 ADDENDUM RISK SCREENING .....	6-1
6.1.1	Risk Screening for Soils COPCs .....	6-1
6.1.2	Derivation of Risk Estimates for Soils COPCs .....	6-1
6.1.3	Risk Screening for Groundwater COPCs .....	6-2
6.1.4	Derivation of Risk Estimates for Groundwater COPCs .....	6-4
6.1.5	Risk Screening Uncertainties.....	6-6
6.2	BGOU RI BHHRA FOR SWMU 4.....	6-7
6.2.1	Identification of COPCs .....	6-7
6.2.2	Exposure Assessment .....	6-7
6.2.3	Toxicity Assessment.....	6-9
6.2.4	Risk Characterization .....	6-9
6.2.5	BGOU RI BHHRA Observations and Conclusions .....	6-14
6.3	REMEDIAL GOAL OPTIONS.....	6-15
6.4	SCREENING ECOLOGICAL RISK ASSESSMENT.....	6-15
7.	SUMMARY AND CONCLUSIONS.....	7-1
7.1	SUMMARY.....	7-1
7.1.1	Resolution of SWMU 4 Data Gaps .....	7-1
7.1.2	Summary of the Risk Screening Evaluation.....	7-6
7.1.3	Summary of Groundwater Protection Screening .....	7-8
7.2	CONCLUSIONS .....	7-8
7.2.1	Data Limitations and Recommendations for Future Work.....	7-9
7.2.2	Recommended Remedial Action Objectives .....	7-9
8.	REFERENCES.....	8-1
APPENDIX A:	TECHNICAL RECORDS .....	A-1
APPENDIX B:	ANALYTICAL DATA AND QUALITY ASSURANCE/QUALITY CONTROL EVALUATION RESULTS .....	B-1
APPENDIX C:	HUMAN HEALTH RISK SCREENING.....	C-1
APPENDIX D:	SCREENING ECOLOGICAL RISK ASSESSMENT.....	D-1
APPENDIX E:	SWMU 4 TEST PIT PHOTOGRAPHS .....	E-1



## TABLES

ES.1.	Summary of Estimated Maximum Direct Contact Total ELCR and Total HI for SWMU 4 .....	ES-8
ES.2.	Summary of Suite of COPECs Retained in Soil .....	ES-8
1.1.	SWMU 4 Additional Characterization Data Gaps and DQOs .....	1-3
2.1.	Summary of Deviations from the SAP .....	2-10
2.2.	Summary of SWMU 4 Investigation QC Sampling.....	2-12
2.3.	QA Assessment for Laboratory Measurements of RI Data .....	2-14
3.1.	Summary of Groundwater Geochemical Data for SWMU 4 .....	3-1
3.2.	Estimated Groundwater Flow Velocity at SWMU 4 .....	3-9
4.1.	Screening Values for Surface Soil .....	4-3
4.2.	Screening Values for Subsurface Soil.....	4-5
4.3.	Screening Values for Groundwater.....	4-7
4.4.	SWMU 4 Surface Soil (0-1 ft bgs) Data Summary .....	4-9
4.5.	SWMU 4 Subsurface Soil (1-60 ft bgs) Data Summary .....	4-18
4.6.	Burial Cell 1 Sample Locations and Depths of the Contaminants Detected above Screening Levels in SWMU 4 for Soil 1–60 ft bgs .....	4-23
4.7.	Burial Cell 2 Sample Locations and Depths of the Contaminants Detected above Screening Levels in SWMU 4 for Soil 1–60 ft bgs .....	4-29
4.8.	Burial Cell 3 Sample Locations and Depths of the Contaminants Detected above Screening Levels in SWMU 4 for Soil 1–60 ft bgs .....	4-35
4.9.	Burial Cell 4 Sample Locations and Depths of the Contaminants Detected above Screening Levels in SWMU 4 for Soil 1–60 ft bgs .....	4-41
4.10.	Burial Cell 5 Sample Locations and Depths of the Contaminants Detected above Screening Levels in SWMU 4 for Soil 1–60 ft bgs .....	4-49
4.11.	Inter-Cell Sample Locations and Depths of the Contaminants Detected above Screening Levels in SWMU 4 for Soil 1–60 ft bgs .....	4-54
4.12.	Sample Locations and Depths of Contaminants Detected in SWMU 4 for Soil > 60 ft bgs .....	4-60
4.13.	SWMU 4 UCRS Groundwater Contaminants .....	4-73
4.14.	SWMU 4 RGA Groundwater Contaminants .....	4-76
4.15.	SWMU 4 McNairy Formation Groundwater Contaminants .....	4-79
6.1.	Estimated Potential ECLRs and HIs Posed to the Industrial Worker and Excavation Worker by COPCs Found in SWMU 4 Soils.....	6-1
6.2.	Estimated Potential ECLRs and HIs Posed to the Child Resident by COPCs Found in SWMU 4 Groundwater .....	6-5
6.3.	Summary of Risk Characterization from BGOU RI for SWMU 4 .....	6-12
6.4.	COPECs Retained in Surface Soil at SWMU 4 from BGOU RI.....	6-15
6.5.	COPECs Retained in Surface and Shallow Subsurface Soil (0–5 ft bgs) at SWMU 4.....	6-16
6.6.	Ecological Screening of SWMU 4.....	6-16
7.1.	Summary of Estimated Maximum Direct Contact Total ELCR and Total HI for SWMU 4.....	7-7
7.2.	Summary of Suite of COPECs Retained in Soil .....	7-7

**THIS PAGE INTENTIONALLY LEFT BLANK**

## FIGURES

1.1.	SWMU 4 Location at PGDP.....	1-2
1.2.	SWMU 4 Layout.....	1-6
1.3.	Approximate Areas of the Five Primary Burial Cells at SWMU 4 Based on Geophysical Interpretations .....	1-8
1.4.	Historical Soil Sampling Locations at SWMU 4 .....	1-10
1.5.	Historical Groundwater Sampling Locations at SWMU 4 .....	1-11
1.6.	TCE in Groundwater from Historical Sampling at SWMU 4.....	1-12
2.1.	BGOU RI Addendum Sample Locations—Surface Soil .....	2-2
2.2.	BGOU RI Addendum Sample Locations—Soil Gas .....	2-4
2.3.	BGOU RI Addendum Sample Locations—Subsurface Soil.....	2-6
2.4.	BGOU RI Addendum Sample Locations—Groundwater.....	2-8
3.1.	Depth to Water Measured in UCRS Monitoring Wells .....	3-3
3.2.	UCRS Water Levels Measured in Monitoring Wells .....	3-4
3.3.	UCRS Water Levels at SWMU 4 (May 2014) .....	3-5
3.4.	UCRS Water Levels at SWMU 4 (November 2014).....	3-6
3.5.	RGA Water Levels at SWMU 4 (February 2016) .....	3-8
4.1.	BGOU RI Addendum Surface Soil Samples Exceeding Industrial Worker NALs and ALs for Metals .....	4-13
4.2.	BGOU RI Addendum Surface Soil Samples Exceeding Industrial Worker NALs and ALs for PCBs.....	4-14
4.3.	BGOU RI Addendum Surface Soil Samples Exceeding Industrial Worker NALs and ALs for Radionuclides .....	4-15
4.4.	BGOU RI Addendum Subsurface Soil Sampling—Associated Cells .....	4-22
4.5.	BGOU RI Addendum Subsurface Soil Uranium (Metal) Results .....	4-64
4.6.	BGOU RI Addendum Subsurface Soil Trichloroethene Results .....	4-65
4.7.	TCE in Subsurface Soil (Modeled Distribution).....	4-66
4.8.	BGOU RI Addendum Subsurface Soil Vinyl Chloride Results.....	4-68
4.9.	BGOU RI Addendum Soil Gas Results .....	4-69
4.10.	BGOU RI Addendum Subsurface Soil Uranium-238 Results .....	4-71
4.11.	BGOU RI Addendum Subsurface Soil Technetium-99 Results .....	4-72
4.12.	TCE in SWMU 4 UCRS Groundwater Sampling.....	4-75
4.13.	TCE in SWMU 4 RGA Groundwater Sampling.....	4-78
4.14.	TCE in RGA Groundwater from Temporary Borings from Addendum Sampling at SWMU 4.....	4-81

**THIS PAGE INTENTIONALLY LEFT BLANK**

## ACRONYMS

AL	action level
amsl	above mean sea level
BGOU	Burial Grounds Operable Unit
bgs	below ground surface
BHHRA	Baseline Human Health Risk Assessment
CERCLA	Comprehensive Environmental Response, Compensation, and Liability Act
COC	contaminant of concern
COPC	chemical or radionuclide of potential concern
COPEC	chemical or radionuclide of potential ecological concern
DAF	dilution attenuation factor
DL	detection limit
DNAPL	dense nonaqueous-phase liquid
DOE	U.S. Department of Energy
DPT	direct push technology
DQO	data quality objective
EDD	electronic data deliverable
ELCR	excess lifetime cancer risk
EPA	U.S. Environmental Protection Agency
EPC	exposure point concentration
ERH	electrical resistance heating
FFA	Federal Facility Agreement
FOD	frequency of detection
FOE	frequency of exceedance
FS	feasibility study
GC	gas chromatograph
GWOU	Groundwater Operable Unit
HI	hazard index
KDEP	Kentucky Department for Environmental Protection
MCL	maximum contaminant level
MDL	method detection limit
MS	matrix spike
MSD	matrix spike duplicate
MW	monitoring well
NAL	no action level
NIST	National Institute of Standards and Technology
PEMS	Paducah Project Environmental Monitoring System
PGDP	Paducah Gaseous Diffusion Plant
POC	pathway of concern
POE	point of exposure
PQL	practical quantitation limit
PRG	preliminary remediation goal
PTW	principal threat waste
QA	quality assurance
QC	quality control
RAO	remedial action objective
RCRA	Resource Conservation and Recovery Act
RGA	Regional Gravel Aquifer
RGO	remedial goal option

RI	remedial investigation
RL	reporting limit
RPD	relative percent difference
SAP	sampling and analysis plan
SERA	screening ecological risk assessment
SI	site investigation
SOP	standard operating procedure
SRM	standard reference material
SSL	soil screening level
SVOA	semivolatile organic analyte
SVOC	semivolatile organic compound
SWMU	solid waste management unit
TVA	Tennessee Valley Authority
UCRS	Upper Continental Recharge System
USEC	United States Enrichment Corporation
VOC	volatile organic compound
WAG	waste area grouping
XRF	X-ray fluorescence

## EXECUTIVE SUMMARY

The Paducah Gaseous Diffusion Plant (PGDP) is an inactive uranium enrichment facility that is owned by the U.S. Department of Energy (DOE). DOE is conducting environmental restoration activities at PGDP in accordance with the requirements of the Paducah Federal Facility Agreement (FFA), which coordinates Resource Conservation and Recovery Act and the Comprehensive Environmental Response, Compensation, and Liability Act (CERCLA) cleanup requirements. PGDP was placed on the National Priorities List in 1994. DOE, the U.S. Environmental Protection Agency (EPA), and the Commonwealth of Kentucky (Kentucky) entered into an FFA in 1998 (EPA 1998).

The Burial Grounds Operable Unit (BGOU) is one of several operable units (OUs) at PGDP being used to evaluate and implement remedial actions. Administratively, Solid Waste Management Unit (SWMU 4) is within the BGOU, which is a portion of the PGDP that is subject to a Remedial Investigation/Feasibility Study (RI/FS).

In January 2011, EPA, the Commonwealth of Kentucky, and DOE convened a meeting to discuss SWMU 4 data gaps and uncertainties that remained after completion of the BGOU RI report (DOE 2010a). They developed data quality objectives and incorporated them into a sampling plan to address those gaps. The SWMU 4 investigation followed the field sampling plan outlined in the BGOU RI/FS Work Plan Addendum (DOE 2014). The primary goal of this supplemental remedial investigation was to address the identified data gaps by further characterization of nature, extent, and magnitude of source zones and secondary sources (such as contaminated soil) at SWMU 4.

This BGOU RI Report Addendum was prepared following the outlines found in Appendix D of the FFA for PGDP (EPA 1998) and is consistent with the elements found in Appendix D of the *Work Plan for the Burial Grounds Operable Unit Remedial Investigation/Feasibility Study at the Paducah Gaseous Diffusion Plant, Paducah, Kentucky* (DOE 2006). Some sections of the approved BGOU RI Report (DOE 2010a) are incorporated by reference into this BGOU RI Report SWMU 4 Addendum.

Separate vertical boundaries and media designations were established for defining the nature and extent of contamination at SWMU 4 and for estimating potential risks at SWMU 4. These boundaries are as follows:

- **Surface Soils.** The vertical extent of surface soils with respect to nature and extent of contamination was 0–1 ft below ground surface (bgs). These soils were screened against surface background values and groundwater protection screening values for the Upper Continental Recharge System (UCRS) [i.e., a dilution attenuation factor (DAF) of 1] and for the Regional Gravel Aquifer (RGA) (i.e., a DAF of 58). Additionally, surface soils were screened against industrial worker no action levels (NALs)/action levels (ALs) and excavation worker NALs/ALs.
- **Subsurface Soils.** The vertical extent of subsurface soil with respect to nature and extent of contamination was 1–60 ft bgs. These soils were screened against subsurface background values and groundwater protection screening values for the UCRS and for the RGA. Subsurface soils from 1–20 ft bgs also were screened against excavation worker NALs/ALs for nature and extent comparison. [The Risk Methods Document lists 0–16 ft bgs for comparison to the excavation worker (DOE 2015); however, the maximum depth of 20 ft is used in order to encompass fully the maximum depth of burial.] Potential risks were estimated for the excavation worker using surface and subsurface soils (0–20 ft bgs). Soils deeper than 60 ft bgs are not screened against groundwater protection screening values or background because they are within the RGA.

- **Groundwater.** Results from groundwater samples are divided into UCRS, RGA, and McNairy data sets. Groundwater data were screened against residential NALs/ALs and maximum contaminant levels for nature and extent comparison. Additionally, RGA and McNairy data were screened against background values. Potential risks were estimated for the child resident using RGA and McNairy results.

Sampling of SWMU 4 was conducted in five phases to address the identified data gaps and DQOs. Phase I included surface soil sampling (five-point composites from 45-ft grids) and passive soil gas sampling. Due to the large number of surface soil samples collected using the gridded sampling approach, most of the samples were analyzed using field analytical instruments. The passive gas soil samplers were employed to obtain screening-level results to help select Phase II subsurface sampling locations.

Phase II was implemented with 22 borings advanced to a depth of 20 ft bgs using direct push technology (DPT). These borings were sampled to identify volatile organic compounds (VOCs) and other contaminants of concern (COCs) in burial cells and in the UCRS inter-cell areas (i.e., sample locations not located within the burial cell boundaries) of SWMU 4. Seven borings were converted to monitoring wells (MWs) to assist in determining the water table depth. Also, as part of Phase II, test pits were excavated in each burial cell, and two test pits were excavated in Burial Cell 4 (while test pit excavation was a Phase II activity, because of the depth interval in question, chronologically, the pits were excavated at the end of Phase V due to the logistical complexities).

Phase III of the investigation focused on the UCRS at depths ranging from 20 ft bgs to the top of the RGA (approximately 60 ft bgs). Twenty-seven borings were installed using DPT to collect soil samples at 10-ft depth intervals for laboratory analysis.

Phase IV was implemented by drilling ten borings to the top of the McNairy Formation (total depth of approximately 105 ft). Borings were installed adjacent to the burial cells to avoid penetration of the burial cells and to prevent creation of a migratory conduit into the RGA. Both soil samples and groundwater samples were collected from these borings.

Phase V was implemented by installing four RGA MWs to support data gaps related to trichloroethene (TCE) mass in the RGA and to provide data related to hydraulic conductivity and groundwater flow direction in the RGA.

#### **SWMU 4 DATA GAPS**

As part of the Data Quality Objective meetings in January 2011, data at SWMU 4 were determined to be sufficient to develop an excavation alternative for buried materials and associated contaminated soils at SWMU 4, but it was not sufficient to optimize remedy selection or support remedial design. The BGOU RI Addendum investigation for SWMU 4, completed through the implementation of five phases of investigation following completion and approval of the BGOU RI Report, was needed to address remaining uncertainties and data gaps. The data from these five phases were combined with the historical data to form a comprehensive data set for evaluation. The data gaps previously identified and the conclusions reached by this implementation are addressed below.

***Data Gap 1:** There are insufficient data at SWMU 4 to determine whether trichloroethene (TCE) is present in each of the burial cells, and the extent and mass of TCE contamination with sufficient accuracy to effectively and efficiently complete a remedial design for a TCE remedy in the burial cells.*

TCE was detected infrequently in samples collected within Burial Cells 1, 4, and 5 (subsurface soil samples collected to 20-ft depth). The maximum TCE concentration from these samples was 1.5 mg/kg in



Burial Cell 1. TCE was not detected in either Burial Cell 2 or Burial Cell 3. In soil samples collected beneath SWMU 4, TCE is present primarily beneath Burial Cell 4.

**Data Gap 2:** *There are insufficient data at SWMU 4 to determine the extent and mass of TCE contamination with sufficient accuracy to effectively and efficiently complete a remedial design for TCE in the UCRS (i.e., soils from ground surface to the top of the RGA not identified as burial cells).*

The modeled TCE distribution in subsurface soil (at depths from 1 to 60 ft), based on historical soil data and data from this investigation, estimates the total mass of TCE in UCRS soil (at concentrations greater than 0.075 mg/kg) to be approximately 744 lb (approximately 61 gal of TCE), which is distributed throughout the subsurface. Note that 0.075 mg/kg of TCE is an estimated soil cleanup level based on the cleanup level calculated for TCE sources near the C-720 Building. SWMU 4 cleanup levels will be developed further in the FS. There are two zones in the subsurface, with areal dimensions of approximately 0.16 acres and 0.23 acres, where concentrations greater than 1.0 mg/kg exist, and both are found primarily beneath Burial Cell 4. Most of the TCE mass occurs in the subsurface between depths of 20 ft and 60 ft bgs. Maximum detected TCE in subsurface soil was 750 mg/kg at a depth of 25 to 30 ft bgs beneath the western portion of Burial Cell 4. In addition, dissolved TCE in UCRS groundwater provides supporting information that a TCE dense nonaqueous-phase liquid (DNAPL) source likely is present. The depths of groundwater with TCE concentrations greater than 11,000 µg/L (greater than one percent effective solubility of TCE, which is a general criterion used to indicate that DNAPL may be present in the vicinity) in the UCRS varied from 21 ft to 60 ft bgs, and all occurrences were in the vicinity of Burial Cell 4.

**Data Gap 3:** *There are insufficient data at SWMU 4 to determine the extent and mass of TCE source term with sufficient accuracy to effectively and efficiently complete a remedial design for source term in the RGA.*

Reports from previous investigations (DOE 2007a; DOE 2010a) had interpreted an area with TCE concentrations greater than 10,000 µg/L in the RGA (the RGA is encountered from approximately 60 ft to 100 ft bgs at SWMU 4) immediately downgradient of SWMU 4 as being derived from a potential DNAPL zone in the RGA. During this investigation, there were only two RGA groundwater samples from temporary borings that had TCE concentrations of 10,000 µg/L or greater. One sample was from the upper RGA (12,000 µg/L at 75 ft depth interval) in boring 004-004P4 and the other was 10,000 µg/L from the 85-ft depth interval in boring 004-005P4. With only one RGA groundwater sample slightly exceeding the “one percent effective solubility” criterion of 11,000 µg/L, the elevated TCE concentrations in the RGA likely are the result of a TCE DNAPL in the UCRS rather than a DNAPL source zone within the RGA.

**Data Gap 4:** *There are insufficient data at SWMU 4 to determine with sufficient certainty whether contaminants of concern (COCs) other than TCE in the five primary burial cells represent a migration risk to the RGA or principal threat waste (PTW).*

The SI Report for the Southwest Plume VOC Sources (DOE 2007a) stated that Tc-99 contaminated groundwater exceeding the derived MCL of 900 pCi/L had migrated beyond the SWMU 4 boundary and that SWMU 4 was likely the source. The results of this supplemental investigation at SWMU 4 show that technetium-99 (Tc-99) represents a migration risk because it was detected in soils associated with each burial cell at concentrations that exceed soil screening value for protection of UCRS and RGA groundwater (see Tables 4.6, 4.7, 4.8, 4.9, and 4.10 for a comparison against RGA SSLs), and it frequently exceeds the no action value for RGA groundwater (see Table 4.13). Tc-99 was not detected above the derived MCL of 900 pCi/L in any of 288 RGA samples and has been detected above 900 pCi/L in only 3 of 44 samples in the UCRS. The supplemental investigation and prior

investigations have not found Tc-99 containing source materials in a significant quantity or high concentrations within the areas sampled. The collected data do not support identifying Tc-99-contaminated material as PTW at SWMU 4.

The results of the investigation confirm the presence of TCE PTW below SWMU 4. Per the BGOU Dispute Resolution Agreement, the FS for SWMU 4 will identify the TCE DNAPL and high concentration TCE in soils as PTW. The supplemental investigation did identify TCE in UCRS groundwater at concentrations indicative of DNAPL below Burial Cell 4.

The February 2012 *Resolution Agreement of the Formal Dispute* identified certain uranium wastes in SWMU 2 and SWMU 3 as PTW based upon historical disposal records and process knowledge. No uranium source materials such as those described in historical records for SWMU 2 (i.e., uranium shavings and sawdust, and drums of uranyl fluoride solution), and SWMU 3 (i.e., bulk uranium and possible pyrophoric uranium) were observed during this supplemental investigation at SWMU 4; however, potential uranium source materials were identified. These potential uranium source materials include scrap metal, slag, and discolored soil unearthed in Test Pit 5 of Burial Cell 4; some of these materials produced radiological survey readings in excess of 100,000 dpm/100cm<sup>2</sup> beta/gamma. The soil sample associated with this material contained uranium metal and uranium-238 (U-238) above the excavation worker action levels (see Table A2.2). Uranium concentrations above action levels also were seen in three subsurface samples collected from Burial Cell 4 and one subsurface sample collected from Burial Cell 2. These samples, 4 of over 300 samples collected from across the entire SWMU, represent the only areas in which potential uranium source materials were identified as exceeding the excavation worker action levels in SWMU 4. In Test Pit 4 of Burial Cell 3, approximately one-gal of a green liquid drained from a metal pipe being removed from the pit. The pipe containing the liquid produced radiological survey readings in excess of 100,000 dpm/100cm<sup>2</sup> beta/gamma, but uranium metal and uranium isotopes concentrations did not exceed excavation worker action levels.

Although no “threshold level” of risk has been established by EPA to identify principal threat waste, a general rule of thumb is to consider as a principal threat those source materials with toxicity and mobility characteristics that combine to pose a potential risk several orders of magnitude greater than the risk level that is acceptable for the current or reasonably anticipated future land use, given realistic exposure scenarios. Based upon application of EPA guidance, the potential uranium source materials identified during the supplemental investigation within Burial Cells 2 and 4 do not represent PTW. First, uranium metal is not highly toxic. Second, based upon historical groundwater analyses, neither uranium metal nor uranium isotopes are present in a highly mobile form at SWMU 4. Specifically, uranium metal has never been detected in RGA groundwater at SWMU 4, and uranium isotopes were detected only once. This single detection was in a 1999 sample from MW333 located approximately 100 ft north of SWMU 4. In that instance, the uranium isotope activities were below their respective PGDP-derived MCLs, and subsequent RGA groundwater samples contained no uranium isotopes. However, as stated in Section 4.3 of the SWMU 4 RI Addendum, uranium-234, uranium-235, and uranium-238 isotopes were detected at levels that exceed SSLs for protection of both UCRS and RGA groundwater. Finally, the comparison to risk-based values (see Tables 4.7, 4.9, and A.2.2) indicate that the U-238 concentrations from potential source materials that were collected in Cells 2 and 4 present an excess lifetime cancer risk of between 1E-04 and 1E-03 for the excavation worker. This incremental risk is not several orders of magnitude greater than the 1E-04 risk level that is acceptable for the current or reasonably anticipated future land use and, therefore, is indicative of low-level threat waste. Similarly, the maximum uranium metal concentration from potential source materials is 11,100 mg/kg, less than one order of magnitude greater than the action level concentration of 2,950 mg/kg for the excavation worker. DOE has collected 179 surface soil samples, 136 subsurface soil samples, and 111 groundwater samples to characterize uranium contamination at SWMU 4. The collected data for SWMU 4 do not indicate the presence of high concentrations or significant quantities of uranium or potential uranium source material.

**Data Gap 5:** *There are insufficient data at SWMU 4 to determine the extent and mass of COCs other than TCE with sufficient accuracy to effectively and efficiently select and design a remedy for the UCRS (i.e., not burial cells or geophysical anomalies).*

Sufficient subsurface soil data, as well as UCRS groundwater data, now exist for SWMU 4 to determine the mass and extent of contaminants to select and design effectively and efficiently a remedy for the subsurface soils.

Only the metals iron, nickel, and uranium exceeded background in more than 10% of the analyses and also exceeded the excavation worker NAL. Uranium was the most commonly detected metal which exceeded both background and risk-based levels. Uranium was detected above the excavation worker ALs in four samples. Uranium concentrations ranged up to 11,100 mg/kg. The highest concentrations of uranium were found in Burial Cells 2 and 4, typically in the 5 to 10-ft depth interval, not in the underlying UCRS.

Total polychlorinated biphenyls (PCBs) were detected in subsurface soils above the excavation worker NALs in seven percent of the analyses. The maximum detected value was 38 mg/kg of total PCBs in Burial Cell 4, but Burial Cells 1, 2 and 5 also had maximum PCB detections of 10.3, 10.5, and 27 mg/kg, respectively. The highest levels of PCBs all were within the upper 10 ft of the subsurface, not within the underlying UCRS. No semivolatile organic compounds (as analyzed using laboratory method SW-846-8270) were detected above excavation worker NALs.

TCE and several degradation products were the VOCs commonly detected in subsurface soil. The range of detected TCE concentrations in subsurface soil ranged up to 750 mg/kg.

Several radionuclides were detected in subsurface soils. Uranium isotopes were the most common radionuclides to exceed both background and risk-based levels in subsurface soils. Uranium-235 (one sample) and uranium-238 (three samples) also exceeded the excavation worker ALs. The maximum detected activities of the uranium isotopes are found in Burial Cell 4 in the 5 to 10-ft interval. Tc-99 exceeded background in almost 10% of the analyses. Tc-99 also exceeded the UCRS and RGA soil screening level (SSL) in all analyses with detections. The three highest detections of Tc-99 were in the 5-to 10-ft interval in Burial Cell 4, but there also were sporadic background exceedances throughout the UCRS beneath Burial Cell 1 and Burial Cell 4.

For the current SWMU 4 investigation, more than 30 groundwater samples were collected from seven shallow MWs and direct-push borings. The metals that most commonly exceeded all screening criteria in UCRS groundwater were arsenic, barium, beryllium, cadmium, chromium, and lead.

PCBs were detected in 11 of 16 UCRS analyses. PCBs, with a range of detected values up to 0.422 mg/L, exceeded the maximum contaminant level of 0.0005 mg/L in 9 samples. Several VOCs exceeded at least one of the UCRS screening criteria with TCE and associated degradation products being the most common. TCE concentrations in UCRS groundwater ranged up to 197,000 µg/L.

The most common radionuclide detected in UCRS groundwater was Tc-99 with a range of detectable values from 14.5 to 1,640 pCi/L. The maximum Tc-99 in UCRS groundwater was detected in a sample from a depth of 14 to 18 ft within Burial Cell 1. The other two samples that exceeded 900 pCi/L were collected below Burial Cell 4. Most of the UCRS groundwater samples with Tc-99 greater than 100 pCi/L were located along the western side of SWMU 4.

**Data Gap 6:** *There are insufficient data at SWMU 4 to determine the extent and mass of COCs with sufficient accuracy to select and design a remedy for the geophysical anomalies identified in 1999 and 2010 geophysical surveys. Data should be of sufficient quantity and quality to determine whether COCs represent a migration risk to the RGA or PTW.*

The supplemental investigation at SWMU 4 determined the extent and mass of COCs with sufficient accuracy to select and design a remedy for the geophysical anomalies identified in 1999 and 2010 geophysical surveys. The data collected during the supplemental investigation in combination with historical data is of sufficient quantity and quality to determine whether COCs represent a migration risk to the RGA or PTW (migration risk to the RGA and PTW are discussed above in conjunction with Data Gap 4).

**Data Gap 7:** *The depth of the water table at SWMU 4 is uncertain. Specifically, is the buried material at SWMU 4 submerged in water.*

Water level elevations measured in UCRS MWs show that the depth to water across SWMU 4 ranges from approximately 1.1 ft to 11 ft bgs, depending on location and season. Test pit excavations and borings revealed that the base of waste ranges from approximately 5 to 20 ft bgs, depending on location. The supplemental investigation determined that much of the buried material at SWMU 4 is submerged in water at least seasonally and probably all of the time for the deeper burial cells.

**Data Gap 8:** *It is uncertain whether the bedding materials surrounding the raw water pipe in the southeastern portion of the SWMU has been impacted by site constituents and act as a preferential pathway for migration outside of the SWMU.*

Phases I and II of the investigation addressed several data gaps including Data Gap 8, and the data were collected in accordance with the approved work plan. Based on the subsurface soil and passive soil gas data collected from Phases I and II of the SWMU 4 investigation, there is no evidence to suggest the bedding materials surrounding the raw water pipe have been impacted by site constituents or that the bedding materials act as a preferential pathway for migration of contaminants outside SWMU 4. Sample locations closer to the pipeline had lower concentrations, or nondetects, compared to those within the cells, and there were no soil gas vapor detections in the samplers deployed near the raw water pipeline.

In addition, the potential for horizontal contaminant migration from the burial pits to the pipeline within the UCRS is small relative to the potential for vertical contaminant migration. The vertical gradient in the UCRS at SWMU 4 is more than an order of magnitude greater than the horizontal gradient. Some lateral movement of contaminants occurs in the UCRS, but these pathways are known to be limited (the lateral dispersion/transport observed in the UCRS occurs as contaminants migrating downward encounter strata with differing properties). Also, based on shallow groundwater level measurements, the observed water levels were below the level of the pipeline for half the year (July 2014 to December 2014).

While there still may be some uncertainty with this data gap, that uncertainty is small based on the data that have been collected and should not preclude the FS from evaluating alternatives for SWMU 4.

**Data Gap 9:** *Hydraulic conductivity of the RGA under SWMU 4, as a measure of groundwater velocity and flow direction, is uncertain.*

Slug tests were performed on the four new RGA MWs at SWMU 4. The results were lower than expected for the RGA (less than 50 ft/day), which may be due to slug tests being extremely sensitive to near-well conditions (e.g., filter pack and well bore); large in-well storage typical of MWs; and formation damage (skin damage) that is not corrected during well development; however, the hydraulic conductivity values

may be representative for this area of the RGA. Based on a range of hydraulic conductivity values, including values from a nearby aquifer test conducted at C-404 and the PGDP sitewide groundwater model, and using SWMU 4-specific hydraulic gradients, the average RGA groundwater velocity ranges from 0.03 (based on SWMU 4-specific hydraulic conductivity) to 2.25 ft/day (based on modeled hydraulic conductivity). The average RGA groundwater flow velocity in other areas of the site with contaminant plumes generally is 1 to 3 ft/day. Because the SWMU 4 slug test data provide hydraulic conductivity values in the low range for the RGA, the FS will consider a wider range of uncertainty surrounding hydraulic conductivity to evaluate remedial alternatives adequately.

**Data Gap 10:** *There are insufficient data at SWMU 4 to determine the extent and mass of COCs in the surface soil within the SWMU 4 boundaries.*

Metals that most commonly exceeded background (and also exceeded the industrial worker NALs) for surface soil (0–1 ft bgs) were chromium and uranium. Chromium exceedances were broadly distributed across SWMU 4 whereas most of the uranium exceedances were in the southwestern portion of the SWMU, most closely related to Burial Cells 3 and 4. The range of detected results for uranium was up to 2,840 mg/kg in surface soils (background for uranium is 4.9 mg/kg).

Total PCBs were detected above the industrial worker NALs in 36% of the analyses and above the industrial worker AL in two (less than one percent) of the analyses. The maximum detected value was 222 mg/kg of total PCBs, which also exceeds the excavation AL. The two sample locations that exceeded the industrial worker AL were closely grouped in the southwestern portion of SWMU 4 above Burial Cell 4.

Uranium-238 was the most common radionuclide to exceed background and the industrial worker NAL for surface soil. Uranium-238 exceeded background in approximately 82% of the analyses and also exceeded the industrial worker AL in one location. The range of detected activities of uranium-238 was up to 231 pCi/g. Uranium-238 is distributed broadly across the SWMU, with the maximum detection occurring above the western end of Burial Cell 4.

## **SUMMARY OF THE RISK SCREENING EVALUATION**

Current land use of SWMU 4 is industrial. Under current use, because of access restrictions, only plant workers and authorized visitors are allowed access to the SWMU. As discussed in the PGDP Site Management Plan (DOE 2015a), foreseeable future land use of the area is expected to be industrial as well.

Consistent with the BGOU Work Plan Addendum (DOE 2014), data collected from this sampling effort has been used to conduct a risk screening for the industrial worker. Risk screening used surface background values and NALs for the industrial worker from the Risk Methods Document (DOE 2015b) for surface soil (0–1 ft bgs) and subsurface background values and excavation worker NALs for the surface and subsurface soil (0–20 ft bgs).

For SWMU 4, there were 6 chemicals or radionuclides of potential concern (COPCs) that had an excess lifetime cancer risk (ELCR) > 1E-06 or hazard index (HI) > 1 for the future industrial worker scenario exposed to surface soil and 8 COPCs that had an ELCR > 1E-06 and/or HI > 1 for the future excavation worker scenario exposed to surface and subsurface soil. COPCs that exceeded a cancer risk of 1E-06 or a hazard above 1.0 included arsenic, Total PAH, Total PCBs, cesium-137, neptunium-237, thorium-230, uranium-234, uranium-235, and uranium-238.

For exposure to groundwater, the BGOU Work Plan Addendum called for comparison to NALs for the child resident exposure scenario because no NALs for an industrial worker being exposed to groundwater have been established (DOE 2014). For groundwater, 17 COPCs in the RGA and 11 COPCs in the McNairy had an ELCR > 1E-06 and/or HI > 1 when compared to the child residential scenario. RGA COPCs with a cancer risk above 1E-06 or hazard above 1.0 include aluminum, arsenic, cobalt, iron, manganese, vanadium, 1,1,2-trichloroethane (TCA), 1,1-dichloroethene (DCE), benzene, carbon tetrachloride, chloroform, *cis*-1,2-DCE, ethylbenzene, TCE, vinyl chloride, Tc-99, and uranium-234. RGA groundwater contaminants exceeding a cancer risk above 1E-04 or hazard above 3.0 include arsenic, cobalt, iron, manganese, vanadium, 1,1,2-TCA, chloroform, *cis*-1,2-DCE, TCE, and vinyl chloride.

Table ES.1 shows a summary of estimated potential direct contact risks for SWMU 4 for the appropriate media/scenario, derived using comparisons to NALs.

**Table ES.1. Summary of Estimated Maximum Direct Contact Total ELCR and Total HI for SWMU 4**

Media	Scenario	Direct Contact	
		Total ELCR	Total HI
Surface Soil (0-1 ft bgs)	Industrial Worker	<b>8.3E-05</b>	< 1
Surface and Subsurface Soil (0-20 ft bgs)	Excavation Worker	<b>7.6E-05</b>	<b>1.1</b>
Groundwater (RGA)	Resident (child)	<b>5.3E-03</b>	<b>732.9</b>
Groundwater (McNairy)	Resident (child)	<b>7.6E-04</b>	<b>222.8</b>

**Bold** indicates total HI > 1 or total ELCR > 1E-06; **bold italics** indicates total HI > 3 or total ELCR > 1E-04.

A screening ecological risk assessment (SERA) was performed for SWMU 4. The SERA was limited to a comparison of maximum concentrations in the upper five ft of soils at the SWMU against ecological screening levels in order to identify chemicals and radionuclides of potential ecological concern (COPECs). The SERA does not consider the limited habitat, SWMU size, or other factors that also need to be considered to characterize ecological risk. The SERA screened metals, radionuclides, PCBs, semivolatile organic compounds (SVOCs) and VOCs. The following observations were made for the SERA and are summarized in Table ES.2.

**Table ES.2. Summary of Suite of COPECs Retained in Soil**

Number of Metals	Number of Rads	Number of PCBs	Number of SVOCs	Number of VOCs
19	2	1	2	0

## SUMMARY OF GROUNDWATER PROTECTION SCREENING

Analytical results from both surface and subsurface soil were compared to screening values (i.e., SSLs) for the protection of both UCRS and RGA groundwater. Contaminants that most commonly exceeded both background values and the screening level for the protection of UCRS groundwater include the following: aluminum, arsenic, barium, cadmium, cobalt, copper, iron, lead, manganese, mercury, nickel, selenium, silver, uranium, vanadium, zinc, Total PCBs, naphthalene, 1,1,2-trichloroethane (TCA), 1,1-DCE, 1,2-dimethylbenzene, benzene, carbon tetrachloride, chloroform, *cis*-1,2-DCE, ethylbenzene, m,p-xylene, tetrachloroethene, toluene, total xylene, *trans*-1,2-DCE, TCE, vinyl chloride, cesium-137, neptunium-237, plutonium-239/240, Tc-99, thorium-230, uranium-234, uranium-235, and uranium-238.

Contaminants that most commonly exceeded both background values and the screening level for the protection of RGA groundwater include the following: arsenic, cobalt, iron, manganese, mercury, nickel, silver, and uranium, Total PCBs, naphthalene, 1,2-dimethylbenzene, benzene, carbon tetrachloride, chloroform, *cis*-1,2-DCE, tetrachloroethene, TCE, vinyl chloride, cesium-137, neptunium-237, Tc-99, thorium-230, uranium-234, uranium-235, and uranium-238.

TCE was the most common organic contaminant to exceed the SSL for protection of RGA groundwater with 64 of 404 analyses exceeding the value. Similar to the vertical distribution of TCE, both *cis*-1,2-DCE and vinyl chloride exceeded groundwater protection SSLs from approximately 15 ft to 60 ft bgs. The radionuclides that most commonly exceeded the SSL for protection of RGA groundwater include Tc-99, uranium-234, and uranium-238. Tc-99 exceeded the RGA SSL in all analyses with detections (detection frequency was 13%). The three highest detections of Tc-99 were in the 5 to 10 ft interval in Burial Cell 4, but all burial cells had Tc-99 activity concentrations exceeding both background and the SSL value.

## CONCLUSIONS

The BGOU Work Plan Addendum identified data gaps that were necessary to be filled in order to optimize remedy selection in the FS or adequately support remedial design. The BGOU Work Plan Addendum was implemented to reduce the remaining uncertainties from previous investigations regarding the nature and extent of the source zone and secondary sources and to support evaluation of remedial technologies in the FS.

The following are the major findings in the SWMU 4 investigation.

- The investigation has provided data, particularly related to nature and extent of contamination at SWMU 4, that are sufficient and adequate for proceeding with the FS and subsequent CERCLA documents.
- Environmental media, specifically subsurface soil and groundwater, have been impacted by releases of contaminants from waste. Contamination resulting from the buried waste is found concentrated in the UCRS soils and groundwater immediately within and under the burial cells, with a lesser amount of contamination dispersed laterally from the cells. In addition, activities at SWMU 4 have resulted in contamination of surface soil.
- TCE trends in the UCRS and RGA groundwater indicate that TCE DNAPL is present at SWMU 4 in the subsurface soils of the UCRS. While TCE contamination is found in Burial Cells 1, 4, and 5, the contaminant levels within the upper 20 ft in the burial cells at SWMU 4 do not indicate the presence of a DNAPL source within the burial cells. This indicates the TCE DNAPL source no longer is present within the burial cells or emanating from an isolated point source at the base of the burial cell (greatest soil concentration of 750 mg/kg TCE was from a sample collected in boring 004-019P3 at a depth interval of 25 to 30 ft beneath Burial Cell 4). Also, the elevated TCE concentrations in the RGA beneath SWMU 4 are likely the result of a TCE DNAPL source in the UCRS, rather than a DNAPL source within the RGA.
- The risk screening update indicates that ELCRs greater than 1E-06 and/or HIs greater than 1 exist for the industrial worker and excavation worker scenarios for surface and subsurface soils, respectively. Arsenic, Total PAHs, Total PCBs, cesium-137, neptunium-237, thorium-230, uranium-234, uranium-235, and uranium-238 present the dominant risks from exposure to surface and subsurface soil. The major contaminants presenting groundwater risks (cancer risks greater than 1E-04 or HI

greater than 3) in the RGA include arsenic, cobalt, iron, manganese, vanadium, 1,1,2-TCA, chloroform, *cis*-1,2-DCE, TCE, and vinyl chloride.

- Ecological risk screening includes several COPECs. COPECs whose maximum concentration was greater than 10 times their ecological screening value include PCBs, PAHs, and metals (aluminum, cadmium, chromium, iron, manganese, mercury, and uranium).
- Analytical results from both surface and subsurface soil were compared to screening values (i.e., SSLs) for the protection of both UCRS and RGA groundwater. Contaminants that most commonly exceeded both background values and the screening level for the protection of RGA groundwater include the following: iron, silver, uranium and its isotopes, Total PCBs, TCE, *cis*-1,2-DCE, vinyl chloride, and Tc-99. TCE and its degradation products exceeded the RGA groundwater protection screening values from approximately 15 ft to 60 ft bgs.



# 1. INTRODUCTION

The Paducah Gaseous Diffusion Plant (PGDP), located approximately 10 miles west of Paducah, Kentucky, and 3.5 miles south of the Ohio River in the western part of McCracken County, is an active uranium enrichment facility owned by the U.S. Department of Energy (DOE). Bordering the PGDP Reservation to the northeast, between the plant and the Ohio River, is a Tennessee Valley Authority (TVA) reservation on which is located the electricity generating Shawnee Fossil Plant.

PGDP was owned and managed first by the Atomic Energy Commission and then the Energy Research and Development Administration, DOE's predecessors; DOE then managed PGDP until 1993. On July 1, 1993, Martin Marietta Utility Services and later the United States Enrichment Corporation (USEC) assumed management and operation of the PGDP enrichment facilities under a lease agreement with DOE. Uranium enrichment operations ceased in June 2013 and USEC returned the leased facilities to DOE in October 2014. DOE is responsible for environmental management activities associated with past operation of PGDP (CERCLIS# KY8-890-008-982). DOE is the lead agency for remedial actions, and the U.S. Environmental Protection Agency (EPA) and the Kentucky Department for Environmental Protection (KDEP) have regulatory oversight responsibilities.

The Burial Grounds Operable Unit (BGOU) consists of contamination associated with PGDP's landfills and burial grounds and additional disposal areas that might exist beneath the former scrap yards. Solid Waste Management Unit (SWMU) 4 is included as a unit within the BGOU and located in the west-central part of PGDP (Figure 1.1). This report is an addendum to supplement the approved RI for the BGOU (DOE 2010a). It describes the additional investigation phases used to fill data gaps described in Section 4 of the BGOU Work Plan Addendum (DOE 2014).

## 1.1 PURPOSE OF ADDENDUM REPORT

The SWMU 4 investigation followed the field sampling plan outlined in the BGOU Remedial Investigation/Feasibility Study (RI/FS) Work Plan Addendum (DOE 2014). The objectives of the investigation included further characterization of nature, extent, and magnitude of source zones and secondary sources (such as contaminated soil) at SWMU 4. This report documents the results of the SWMU 4 investigation. Recommended remedial action objectives (RAOs) are presented in Section 7 of this report and will be further developed in an FS.

## 1.2 PROJECT SCOPE AND RATIONALE

The SWMU 4 field investigation was conducted in five phases to address identified data gaps. As part of the Data Quality Objective (DQO) meetings in January 2011, the existing collective data set was considered sufficient to support an excavation alternative for the buried material and associated contaminated soils at SWMU 4, but was not considered sufficient to optimize a remedy selection or adequately support remedial design. Given the limited density of sampling locations in the disposal cells and finding trichloroethene (TCE) at depth in the Upper Continental Recharge System (UCRS) underlying SWMU 4, additional investigation was needed to address uncertainties in the residual TCE present in the disposal cells and the underlying soils that may act as a continuing source to groundwater contamination. Data from this investigation were combined with historical data collected from previous investigations to provide a comprehensive data set for the evaluation of SWMU 4 provided in this BGOU RI Report Addendum.

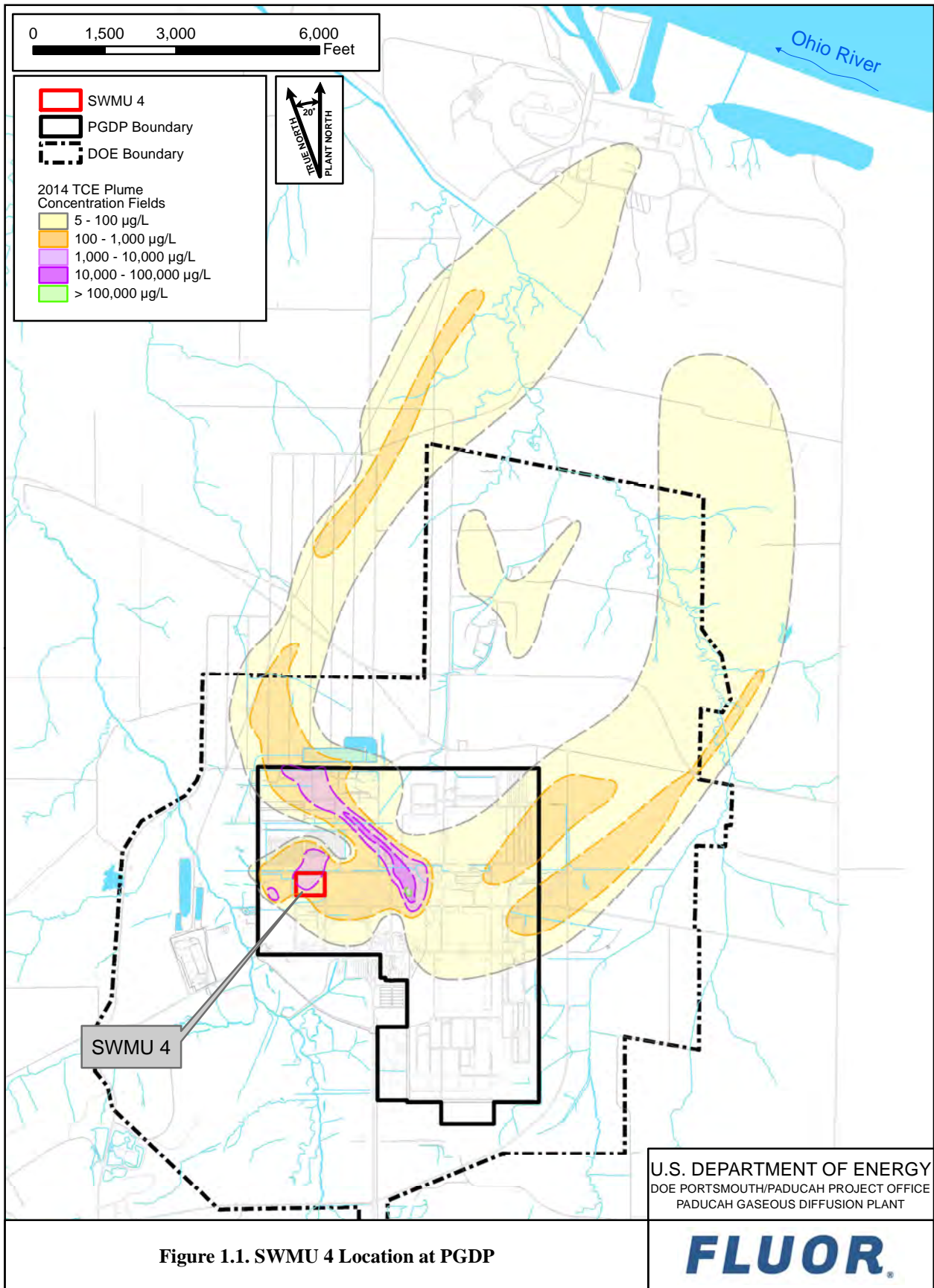

Figure 1.1. SWMU 4 Location at PGDP

The Groundwater Operable Unit (GWOU) Strategic Initiative will address dissolved-phase groundwater contamination in the Regional Gravel Aquifer (RGA) beneath the BGOU SWMUs; however, secondary sources of groundwater contamination that are derived from BGOU burial grounds, such as the potential dense nonaqueous-phase liquid (DNAPL) source zone beneath SWMU 4, remain within the scope of the BGOU for assessment and remedial action, if required.

In January 2011, EPA, the Commonwealth of Kentucky, and DOE convened to discuss SWMU 4 project-related data gaps and associated DQOs for the sampling and analysis needed to address those gaps. Table 1.1 presents the identified data gaps and DQOs, as well as a brief discussion of how fulfilling the DQOs may impact the evaluation of potential remediation alternatives at SWMU 4. While the jointly identified data gaps specified TCE as the volatile organic compound (VOC) of interest, the investigation included sampling and analysis for a broader range of VOCs. Similarly, while the jointly identified data gaps and DQOs focused on burial cells and surrounding area within SWMU 4, the scope of the investigation was extended beyond the administrative boundary of the SWMU, where appropriate, to fulfill DQOs.

The investigative approach to address the data gaps and DQOs is discussed further in Section 2.

**Table 1.1. SWMU 4 Additional Characterization Data Gaps and DQOs**

<b>Data Gap/Problem Statement</b>		<b>Data Quality Objective</b>
1	There are insufficient data at SWMU 4 to determine whether TCE is present in each of the burial cells, and the extent and mass of TCE contamination with sufficient accuracy to effectively and efficiently complete a remedial design for a TCE remedy in the burial cells.	Collect sufficient quantity and quality of VOC sampling data from waste, soil, and water (depending on the depth of the water table) within the SWMU 4 identified burial cells to define the nature and extent of TCE source term in each burial cell. Data should be of sufficient quantity and quality to complete a remedial design for a TCE remedy in the burial cells.
2	There are insufficient data at SWMU 4 to determine the extent and mass of TCE contamination with sufficient accuracy to effectively and efficiently complete a remedial design for TCE in the UCRS (i.e., soils from ground surface to the top of the RGA not identified as burial cells).	Collect sufficient quantity and quality of VOC sampling data from within the UCRS soil (and water where found) to define the nature and extent of TCE source term to complete a remedial design for a TCE remedy in the UCRS.
3	There are insufficient data at SWMU 4 to determine the extent and mass of TCE source term with sufficient accuracy to effectively and efficiently complete a remedial design for source term in the RGA.	<p>Collect sufficient quantity and quality of VOC sampling data from RGA water to define the nature and extent of TCE source term to complete a remedial design for a TCE remedy in the RGA.</p> <p>Collect sufficient quantity and quality of VOC data from soil and water (where encountered) at the base of the UCRS to identify where VOC source term may have penetrated to the RGA.</p> <p>If a free-phase TCE source is determined to extend to the base of the RGA, collect sufficient quantity and quality of VOC data from soil at the interface with the McNairy to complete a remedial design for a TCE remedy in the RGA.</p>

**Table 1.1. SWMU 4 Additional Characterization Data Gaps and DQOs (Continued)**

	<b>Data Gap/Problem Statement</b>	<b>Data Quality Objective</b>
4	There are insufficient data at SWMU 4 to determine with sufficient certainty whether contaminants of concern (COCs) other than TCE in the five primary burial cells represent a migration risk to the RGA or principal threat waste (PTW).	<p>Collect sufficient quantity and quality of sampling data to determine whether non-TCE COCs in the five identified primary burial cells represent PTW.</p> <p>Collect sufficient quantity and quality of sampling data to develop a waste acceptance criteria profile and sufficiently accurate cost estimate for excavation of burial cells and contaminated soils within the SWMU administrative boundary.</p> <p>Collect sufficient quantity and quality of sampling data for COCs other than TCE from waste, soil, and water within the burial cells to define the nature and extent of COCs above preliminary remediation goals (PRGs) protective of RGA groundwater and direct contact.</p>
5	There are insufficient data at SWMU 4 to determine the extent and mass of COCs other than TCE with sufficient accuracy to effectively and efficiently select and design a remedy for the UCRS (i.e., not burial cells or geophysical anomalies).	Collect sufficient quantity and quality of non-TCE COC sampling data from within the UCRS soil to define the nature and extent of COCs above PRGs protective of RGA groundwater and direct contact.
6	There are insufficient data at SWMU 4 to determine the extent and mass of COCs with sufficient accuracy to select and design a remedy for the geophysical anomalies identified in 1999 and 2010 geophysical surveys. Data should be of sufficient quantity and quality to determine whether COCs represent a migration risk to the RGA or PTW.	Collect sampling data for COCs from soil (and water, where found) within the geophysical anomalies identified in 1999 and 2010. Data should be of sufficient quantity and quality to define the nature and extent of COCs above PRGs protective of RGA groundwater and direct contact.
7	The depth of the water table at SWMU 4 is uncertain. Specifically, is the buried material at SWMU 4 submerged in water?	Collect sufficient data to determine the depth of the water table at SWMU 4.
8	It is uncertain whether the bedding materials surrounding the raw water pipe in the southeastern portion of the SWMU have been impacted by site constituents and act as a preferential pathway for migration outside of the SWMU.	Determine whether the bedding materials around the raw water pipe act as a preferential pathway for COCs at the SWMU.
9	Hydraulic conductivity of the RGA under SWMU 4, as a measure of groundwater velocity and flow direction, is uncertain.	Collect sufficient quality and quantity of data to determine the RGA groundwater velocity and flow direction.

**Table 1.1. SWMU 4 Additional Characterization Data Gaps and DQOs (Continued)**

<b>Data Gap/Problem Statement</b>		<b>Data Quality Objective</b>
10	There are insufficient data at SWMU 4 to determine the extent and mass of COCs in the surface soil within the SWMU 4 boundaries.	Collect sufficient quantity and quality of COC sampling data from within the surface soil to define the nature and extent of COCs above PRGs protective of direct contact.

Sampling activities focused on soils and groundwater beneath the SWMU to detect any releases. Section 2 provides details of the investigation activities.

### **1.3 SWMU 4 BACKGROUND**

#### **1.3.1 Site Description**

The C-747 Contaminated Burial Yard and the C-748-B Burial Area (SWMU 4) are located in the western section of the PGDP secured area (Figure 1.2). SWMU 4 (which covers an area of approximately 286,700 ft<sup>2</sup>) is bounded on the north, east, and west by plant roads Virginia Avenue, 6th Street, and 4th Street, respectively, and on the south by an active railroad spur. This SWMU is an open field that, at one time, was used for burial and disposal of various waste materials in designated burial cells. A short, narrow gravel road that enters from the west is nearly completely grass-covered. Except for this rarely used road, the entire site is covered with a variety of field grasses and clovers. The site typically is mowed once a month from April through September. SWMU 4 is bounded on three sides (north, east, and west) by shallow drainage swales that direct surface runoff to the northwest corner of the site. There is an elevation difference of approximately 10 ft between the highest point in the SWMU to the adjacent drainage swales. The entire burial yard was covered with 2 to 3 ft of soil material, and a 6-inch clay cap was placed over the area in 1982 (DOE 1998).

#### **1.3.2 Site History**

The C-747 Burial Yard was in operation from 1951 to 1958 for the disposal of radiologically contaminated and uncontaminated debris originating from the C-410 uranium hexafluoride feed plant. The area originally consisted of two pits covering an area of approximately 8,300 ft<sup>2</sup> (50 ft by 15 ft and 50 ft by 150 ft) (Union Carbide 1978).

According to employee interviews, a majority of the contaminated metal was buried in the northern part of the C-747 Burial Yard. Some of the trash was burned before burial. Scrapped equipment with surface contamination from the enrichment process also was buried. When the yard was closed, a smaller cell was reported to have been dug for the disposal of radiologically contaminated scrap metal (Union Carbide 1978).

The C-748-B Burial Area, located on the west side of C-747, is identified as a “Proposed Chemical Landfill Site” in the 1973 Union Carbide document on waste disposal (Union Carbide 1973). The C-748-B Burial Area was incorporated into SWMU 4 starting in the mid-1990s as a result of the review of a geophysical survey. With this incorporation, the area of the SWMU was changed from 8,300 ft<sup>2</sup> to 286,700 ft<sup>2</sup> (6.58 acres), and this change was documented in a revised SWMU Assessment Report (DOE 2007b). In fall of 1999, employee interviews led to the designation of the area as classified, and appropriate access restrictions were implemented.

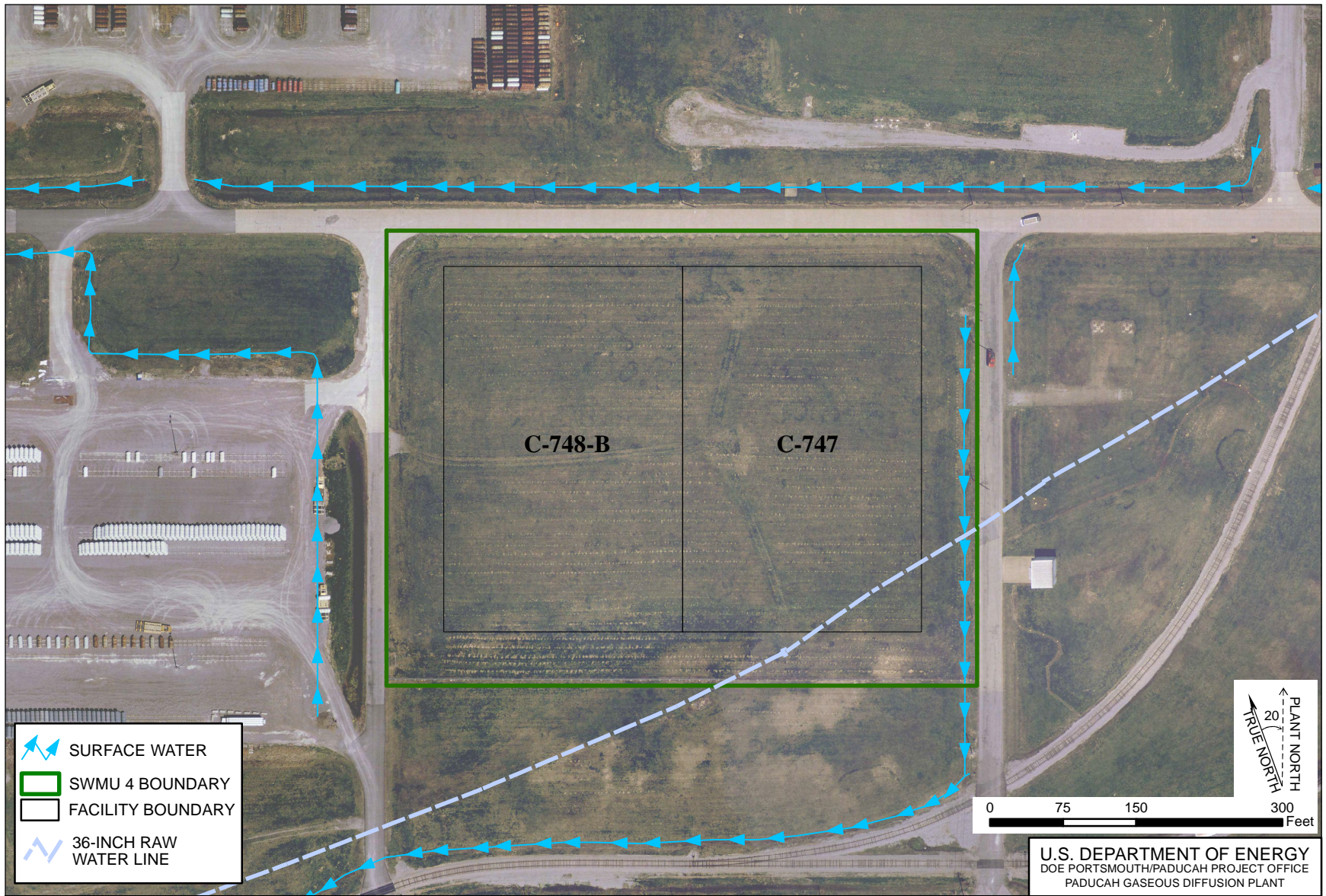

Figure 1.2. SWMU 4 Layout

U.S. DEPARTMENT OF ENERGY  
DOE PORTSMOUTH/PADUCAH PROJECT OFFICE  
PADUCAH GASEOUS DIFFUSION PLANT



SWMU 4 also may have received sludges designated for disposal at the C-404 Burial Ground. The source of these sludges is unknown, but the Waste Area Grouping (WAG) 3 RI Work Plan (DOE 1998) indicated that the sludges potentially included uranium-contaminated solid waste and technetium-99 (Tc-99)-contaminated magnesium fluoride. In the February 10, 2012, MOA resolving the Formal Dispute for the D2 Feasibility Study for the Burial Grounds Operable Unit, the FFA parties, recognized that high-concentration uranium waste intended for disposal at SWMU 3, based upon site history and process knowledge, may have been disposed and, therefore may be present at SWMU 4 (possibly in the form of sludge).

During the summer of 1996, a small sinkhole (approximately 3 ft across and 3 ft deep) developed in the southern burial cell, apparently from settling of material within the SWMU. The sinkhole was backfilled with soil. This hole previously had been reported in the WAG 3 RI Report and the BGOU Work Plan as having developed in fall of 1999.

An active subsurface raw water pipeline is present across the southeastern portion of the SWMU, traversing the SWMU diagonally (Figure 1.2). The pipeline gets as close as ~30 ft from the nearest delineated burial cell. Figure 1.3 presents the approximate areas of the five primary burial cells based on geophysical interpretations. The lowest point of the pipeline is at a depth of approximately 367 ft above mean sea level (amsl), which is approximately 8 to 10 ft below the current grade in the area (DOE 2010b).

Historical and process information indicates that the burial cells have a maximum depth of 15 to 18 ft below ground surface (bgs). The direct measurement of the depth of the water table beneath SWMU 4 reported in the WAG 3 Report has the shallowest groundwater elevation at approximately 18 ft bgs; thus, SWMU 4 waste was not found to be in groundwater during the WAG 3 investigation. Based on other nearby burial grounds, however, there is potential for waste in the burial cells to be located beneath the water table at SWMU 4, and this was investigated further during the current investigation.

The total volume of waste disposed of at SWMU 4 is unknown. Contaminants associated with this SWMU include radionuclides, heavy metals, solvents, VOCs, and polychlorinated biphenyls (PCBs) (DOE 2007a). TCE has migrated from SWMU 4 sources to the primary groundwater unit in the area, the RGA; while all COCs are addressed in the current investigation, TCE is the primary focus of several data gaps.

### 1.3.3 Investigation History

Previous source investigation work in and near SWMU 4 has included geophysical surveys, sampling of soils and groundwater, document research, and personnel interviews. The investigations of SWMU 4 include the Phase II Site Investigation (SI) (CH2M HILL 1992),<sup>1</sup> the WAG 27 RI (DOE 1999a), WAG 3 RI (DOE 2000a), the Data Gaps Investigation (DOE 2000b), and the Southwest Plume SI (DOE 2007a). The BGOU RI (DOE 2010a) summarized the results from those previous investigations and used the results to complete the human health risk assessment and modeling of contaminant migration to the RGA. In addition to the reports of previous investigations, the following documents provide historical context to plant operations and practices as they relate to on-site disposal of waste:

- *The Discard of Scrap Materials by Burial at the PGDP* (Union Carbide 1973); and
- *The Disposal of Solid Waste at the PGDP* (Union Carbide 1978).

---

<sup>1</sup> Consistent with scoping decisions during preparation of the BGOU Work Plan, Phase II SI data are not included in the SWMU 4 dataset because these data, which were collected in the early 1990s, were assumed not to be representative of current conditions (DOE 2006).

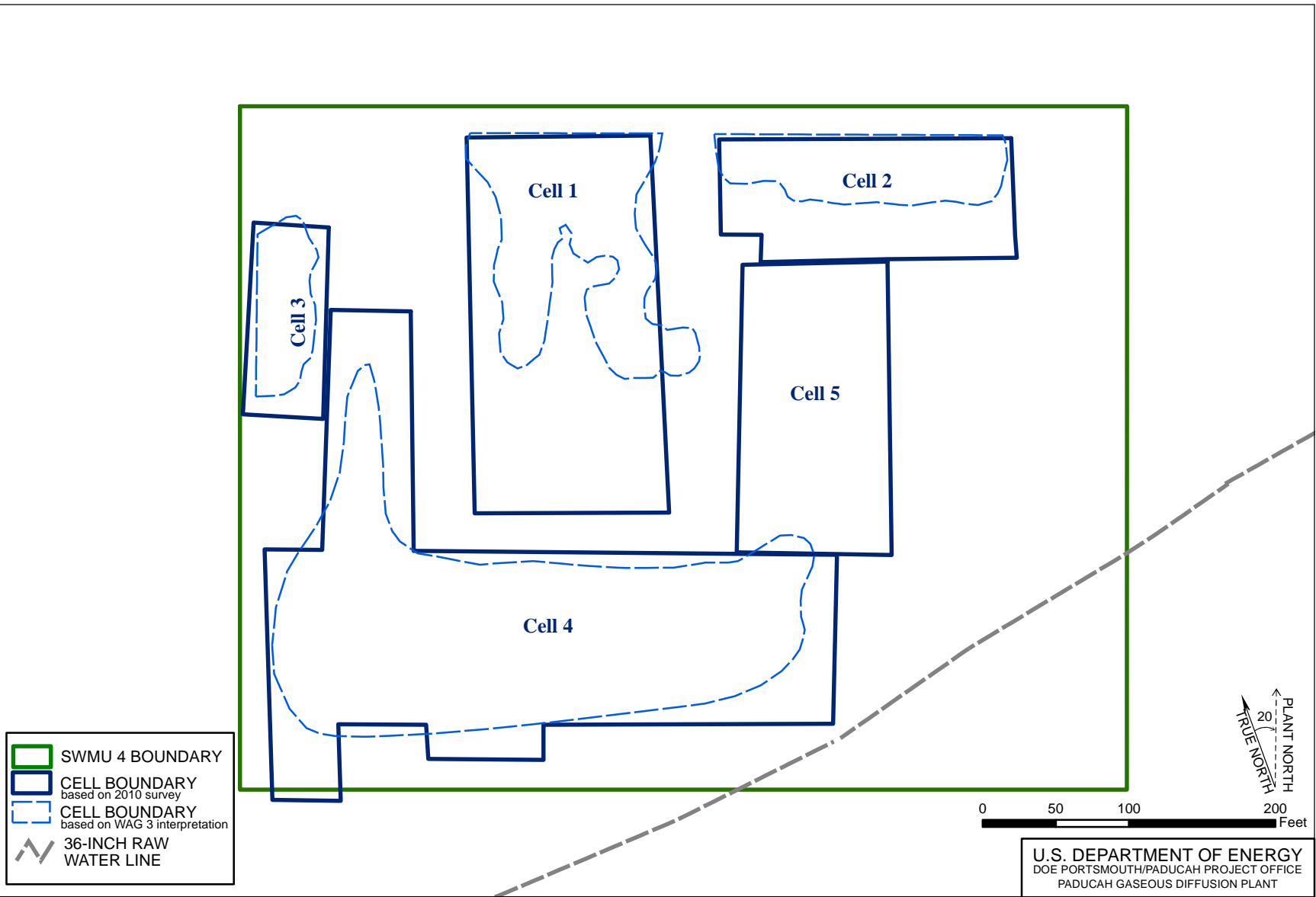

Figure 1.3. Approximate Areas of the Five Primary Burial Cells at SWMU 4 Based on Geophysical Interpretations

U.S. DEPARTMENT OF ENERGY  
DOE PORTSMOUTH/PADUCAH PROJECT OFFICE  
PADUCAH GASEOUS DIFFUSION PLANT





Historical soil sampling locations and historical groundwater sampling locations are provided in Figure 1.4 and Figure 1.5, respectively. Groundwater sampling conducted as part of the WAG 27 RI (DOE 1999a) confirmed the existence of the Southwest Plume. Additional sampling during the Sitewide Evaluation for Source Areas Contributing to Off-Site Groundwater Contamination (commonly called “Data Gaps”) (DOE 2000b) and the WAG 3 RI (DOE 2000a) provided additional detail of the plume’s structure and identified a potential source at SWMU 4 (Figure 1.1 shows SWMU 4 in relation to the sitewide TCE plume as mapped in 2014). Groundwater samples collected during the WAG 3 RI that were located below the primary burial cell, Burial Cell 4, in SWMU 4, included 4 locations with concentrations greater than 10,000 µg/L TCE. Historical groundwater data showing TCE concentrations are provided in Figure 1.6.

During 2008, an RI for all units in the BGOU was conducted. At the time of the BGOU RI Work Plan scoping meetings, it was concluded that sufficient analytical data existed to support decision making for SWMU 4; therefore, no new samples were acquired from SWMU 4 as part of the 2008 RI.

DOE evaluated the potential for applying a removal action to the SWMU 4 waste, as described in the Draft *Engineering Evaluation/Cost Analysis for the C-747 Burial Yard and C-748-B Burial Area (Solid Waste Management Unit 4) at the Paducah Gaseous Diffusion Plant, Paducah, Kentucky*, DOE/LX/07-0335&D1 (DOE 2010b). This removal action anticipated removing buried wastes from SWMU 4 to allow for a subsequent remedial action consisting of treatment by electrical resistance heating (ERH) of the TCE present beneath the burial cells in SWMU 4. These actions were evaluated because SWMU 4 is a known source of TCE migration to the Southwest Plume. In order for ERH to be effective, the metallic debris in the disposal cells and other areas of SWMU 4 would need to be removed. Consequently, it was assumed that the removal action at SWMU 4 would encompass excavation of the buried metallic and associated wastes to a depth of up to 20 ft.

As the BGOU RI/FS process continued, two lessons were learned from application of ERH at the C-400 facility project that impacted evaluation of its application at SWMU 4. First, the cost-effectiveness of an ERH remedy is less sensitive to TCE concentration than to the volume of contaminated soil (i.e., the area to be treated, not the TCE concentration, is the primary influence on cost). Review of the SWMU 4 information identified an uncertainty in the mass of the TCE due in part to the relatively few data points collected from the burial cells. It was concluded that there may be alternatives that are more cost-effective for treating small masses of TCE, and a better estimation of the mass of TCE was needed to support an evaluation of the suitability of ERH as a remedy for SWMU 4. The second lesson from the C-400 project was that ERH is much less cost effective in the RGA than in the UCRS, primarily due to difficulties with heating lower portions of the RGA. This emphasized the need to determine if TCE treatment in the RGA would be required; additional sample points are needed to make this determination. As a result of these developments, the draft Engineering Evaluation/Cost Analysis was not submitted for approval, and the parties to the FFA agreed that the response action for SWMU 4 would follow the Comprehensive Environmental Response, Compensation, and Liability Act (CERCLA) Remedial Action process rather than the CERCLA Removal Action process. The BGOU Work Plan Addendum then was developed to acquire the additional data needed to support remedy selection (DOE 2014).

In 2010, following completion of the BGOU RI report, another geophysical survey was conducted at SWMU 4. Results of this survey were included in the BGOU Work Plan Addendum. The 2010 survey found five anomalies with the EM31 and EM61 instrument surveys. None of the five anomalies is associated with surface metal at the site.

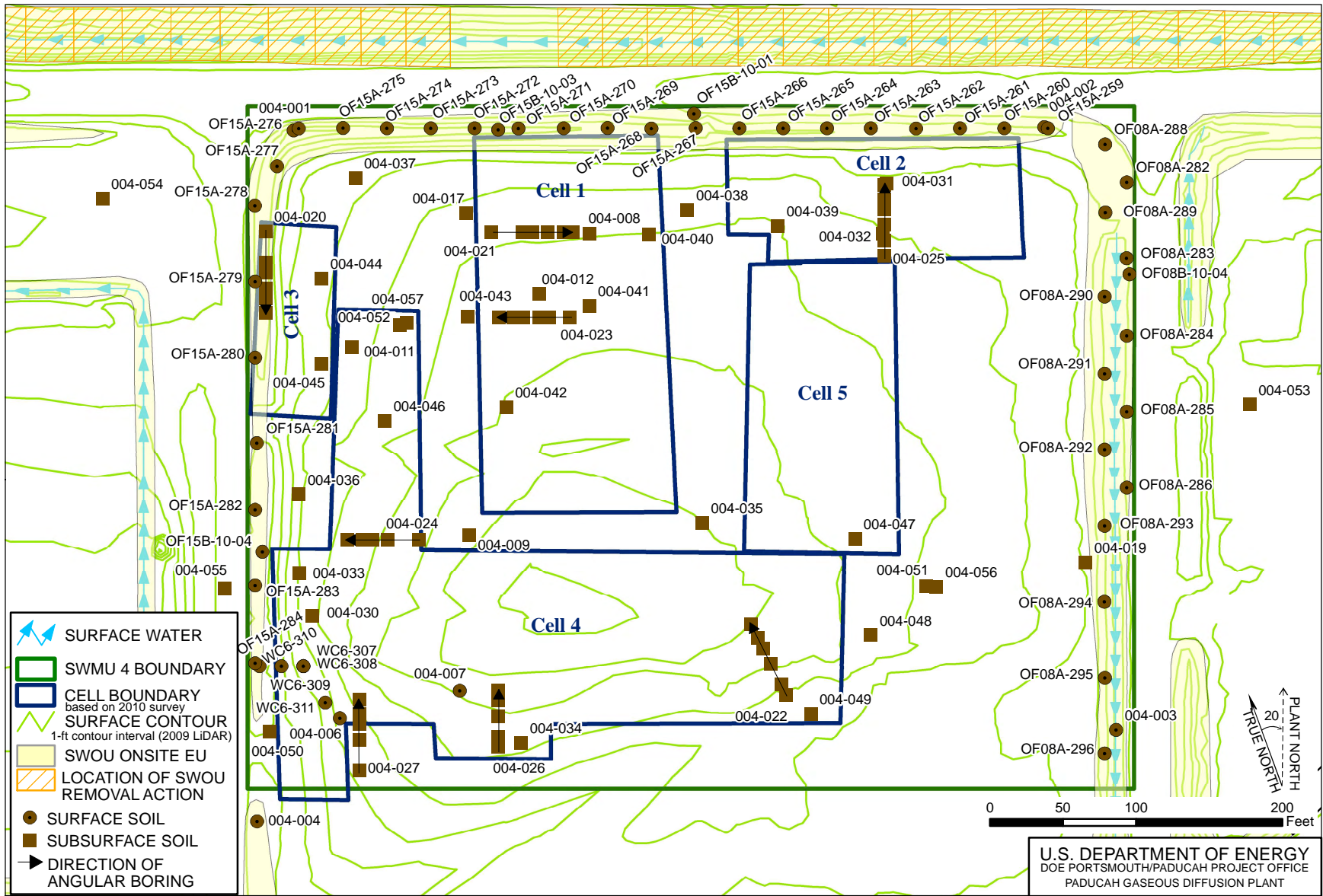

Figure 1.4. Historical Soil Sampling Locations at SWMU 4

U.S. DEPARTMENT OF ENERGY  
DOE PORTSMOUTH/PADUCAH PROJECT OFFICE  
PADUCAH GASEOUS DIFFUSION PLANT



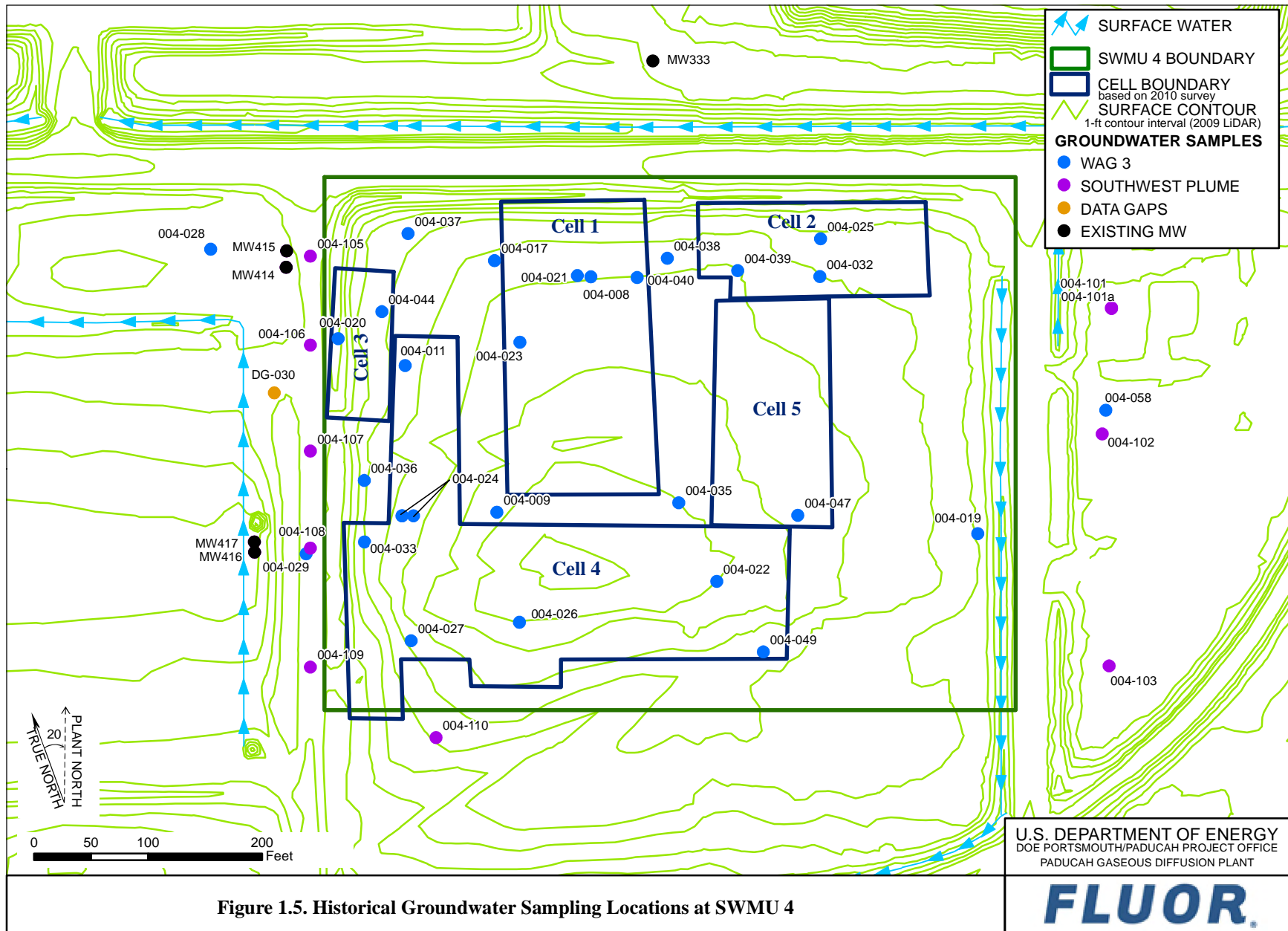

Figure 1.5. Historical Groundwater Sampling Locations at SWMU 4

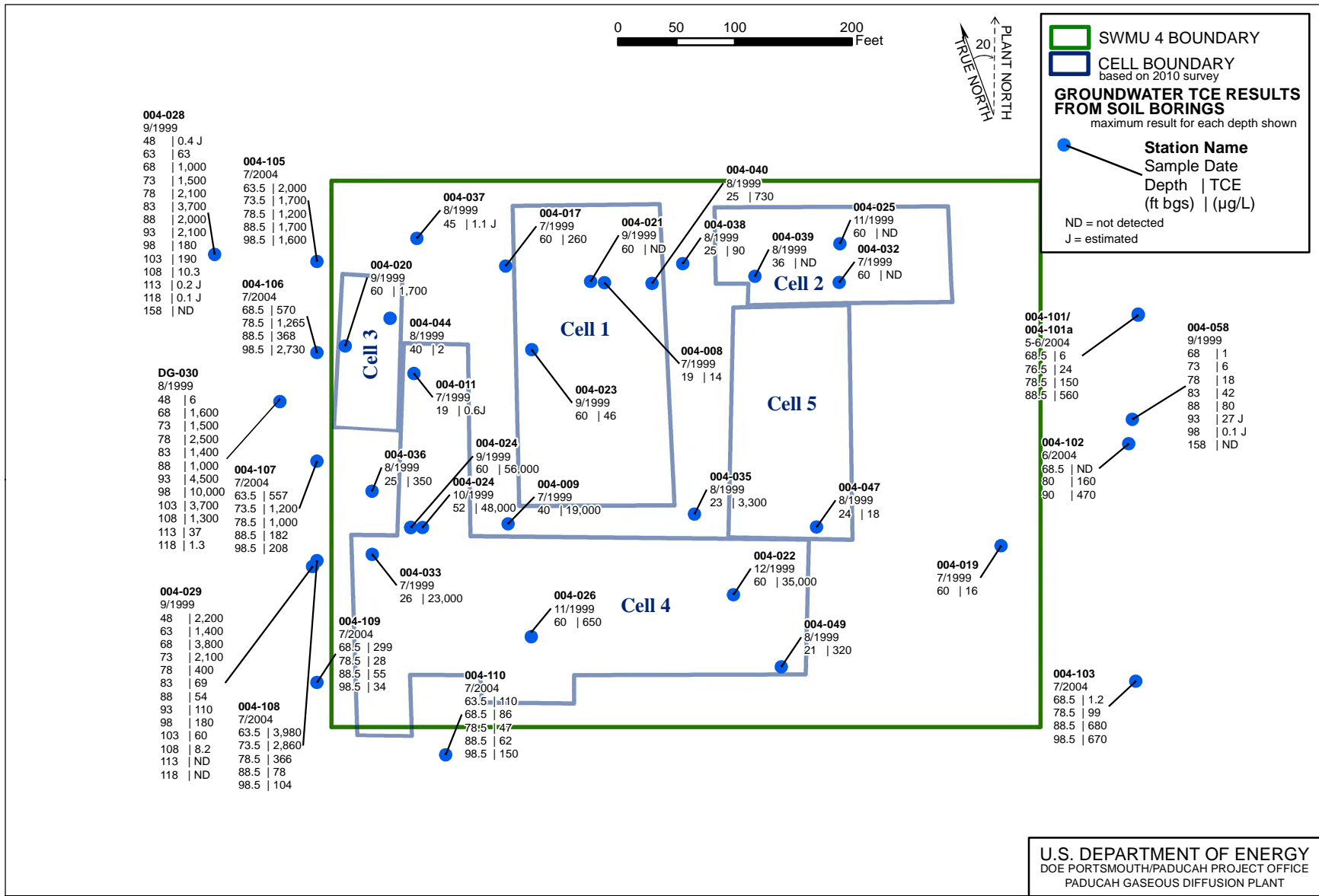

Figure 1.6. TCE in Groundwater from Historical Sampling at SWMU 4

U.S. DEPARTMENT OF ENERGY  
DOE PORTSMOUTH/PADUCAH PROJECT OFFICE  
PADUCAH GASEOUS DIFFUSION PLANT



## 1.4 ADDENDUM REPORT ORGANIZATION

This BGOU RI Report Addendum was prepared following the outline for an RI report found in Appendix D of the FFA for PGDP (EPA 1998). The outline of this report also follows the outline presented in Appendix D of the *Work Plan for the Burial Grounds Operable Unit Remedial Investigation/Feasibility Study at the Paducah Gaseous Diffusion Plant, Paducah, Kentucky* (DOE 2006). The following sections are presented in this report. Some sections of the approved BGOU RI report (DOE 2010a) are incorporated by reference into this BGOU RI Report Addendum.

- Section 1—Introduction
- Section 2—Study Area Investigation
- Section 3—Physical Characteristics of the Study Area
- Section 4—Nature and Extent of Contamination
- Section 5—Fate and Transport
- Section 6—Human Health Risk Evaluation and Ecological Risk Screening
- Section 7—Summary and Conclusions
- Section 8—References

Additionally, the following appendices are included to support the information presented in the text.

- Appendix A—Technical Records
- Appendix B—Analytical Data and Quality Assurance/Quality Control Evaluation Results
- Appendix C—Human Health Risk Screening
- Appendix D—Screening Ecological Risk Assessment

**THIS PAGE INTENTIONALLY LEFT BLANK**

## 2. STUDY AREA INVESTIGATION

This section provides an overview and description of field activities associated with the recent remedial investigation, which was conducted in accordance with the approved BGOU Work Plan Addendum (DOE 2014).

### 2.1 PHASED INVESTIGATIONS

Sampling of SWMU 4 was conducted to address the ten data gaps and DQOs identified in Section 4 of BGOU Work Plan Addendum (Table 1.1). The work was completed through implementation of five phases of investigation. Sections 2.1.1 through 2.1.5 describe the field activities for each phase of the investigation.

#### 2.1.1 Phase I

Phase I was implemented to help resolve the following data gaps.

- #1—There are insufficient data at SWMU 4 to determine whether TCE is present in each of the burial cells and the extent and mass of TCE contamination with sufficient accuracy to effectively and efficiently complete a remedial design for a TCE remedy in the burial cells.
- #8—It is uncertain whether the bedding materials surrounding the raw water pipe in the southeastern portion of the SWMU have been impacted by site constituents and act as a preferential pathway for migration outside of the SWMU.
- #10—There are insufficient data at SWMU 4 to determine the extent and mass of COCs in the surface soil within the SWMU 4 boundaries.

##### 2.1.1.1 Surface soil sampling

Surface soil samples were collected at depths between 0 and 1 ft bgs. Samples were collected as five-point composites from 45-ft grids, resulting in 154 composite samples (Figure 2.1). Each composite sample was comprised of one grab sample collected from the center of the grid and four additional grab samples collected 15 ft from the center point in each cardinal direction (north, south, east, and west). On alternating grids, grab samples were collected from the center of the grid, and four additional grab samples were collected 15 ft from the center point in each secondary direction (northeast, northwest, southeast, southwest). Each individual grab sample represents a 15-ft by 15-ft area (225 ft<sup>2</sup>). The BGOU Work Plan Addendum provides additional detail (DOE 2014). Composite sampling provided an average of the contamination over the grid. Although individual hot spots within the grid may not be evident, the overall benefit of the grid coverage decreases the uncertainty of whether contaminants exist in the area.

Due to the large number of samples collected using the gridded sampling approach, most of the samples were analyzed using field analytical instruments. Though the quantitation limits are higher for these instruments, the increased coverage improves representativeness.

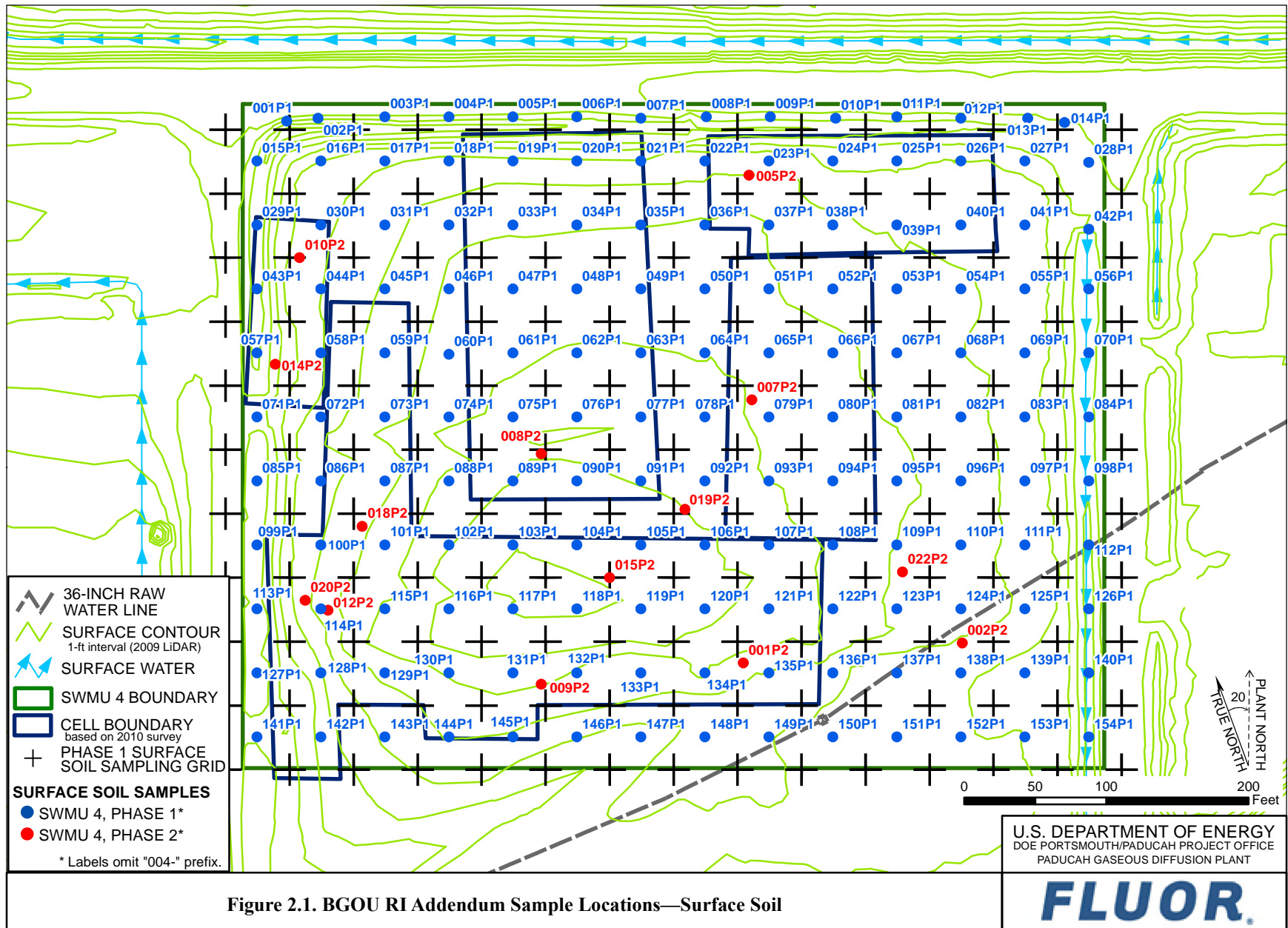

Figure 2.1. BGOU RI Addendum Sample Locations—Surface Soil



Analyses for each composite sample consisted of field analysis of Resource Conservation and Recovery Act (RCRA) metals, plus uranium [using X-ray fluorescence (XRF)] and Total PCB using PCB test kits. Ten percent of the samples had fixed-base laboratory confirmation splits. The fixed-base laboratory samples were selected randomly over all sample locations and analyzed for all COCs with the exception of VOCs.

Using an Olympus-Delta XRF analyzer and associated manufacturer's instructions/training from the instrument vendor, three types of quality control (QC) samples were analyzed with each batch of 20 samples. These included (1) blank, (2) duplicates, and (3) standard reference materials (SRMs). The XRF blanks were vendor-provided. Three SRMs were analyzed daily before use and at four-hour intervals to calibrate and to monitor XRF accuracy. The SRMs represent low [National Institute of Standards and Technology (NIST) 2709], moderate (NIST 2711), and high (NIST 2710) level standards for soil analysis for metals.

The PCB measurements were colorimetric in nature and provided semiquantitative results by employing a field grade colorimeter. Hach-provided standards were used to calibrate the instruments to measure PCB concentration in soil samples.

#### **2.1.1.2 Passive soil gas sampling**

Phase I utilized 65 passive soil gas samplers (modules) to identify areas with elevated VOC soil vapor readings. Passive gas soil samplers were employed to obtain screening-level results to help select Phase II subsurface sampling locations.

Forty-eight modules were placed at the center of a 75 ft by 75 ft grid (except as noted below). A small roped-off area outside of SWMU 4 on the southwest corner that potentially was linked to SWMU 4 included an additional grid and module. Fourteen additional modules were deployed above the burial cells: 10 modules above Burial Cell 4; 2 modules above Burial Cell 2; 1 module above Burial Cell 1; and 1 module above Burial Cell 5. Two additional passive gas samplers were installed to determine any effect the raw water line may have on potential contaminant migration in the area. On September 24, 2012, the passive gas samplers were placed as shown on (Figure 2.2). The modules were left in place 15 days, after which they were collected, placed in sample containers provided by the manufacturer, and shipped to the manufacturer's laboratory for VOC analysis.

#### **2.1.2 Phase II**

Phase II was implemented to support resolution of the following data gaps.

- #1—There are insufficient data at SWMU 4 to determine whether TCE is present in each of the burial cells, and the extent and mass of TCE contamination with sufficient accuracy to effectively and efficiently complete a remedial design for a TCE remedy in the burial cells.
- #4—There are insufficient data at SWMU 4 to determine with sufficient certainty whether COCs other than TCE in the five primary burial cells represent a migration risk to the RGA or PTW.
- #6—There are insufficient data at SWMU 4 to determine the extent and mass of COCs with sufficient accuracy to select and design a remedy for the geophysical anomalies identified in 1999 and 2010 geophysical surveys. Data should be of sufficient quantity and quality to determine whether COCs represent a migration risk to the RGA or PTW.

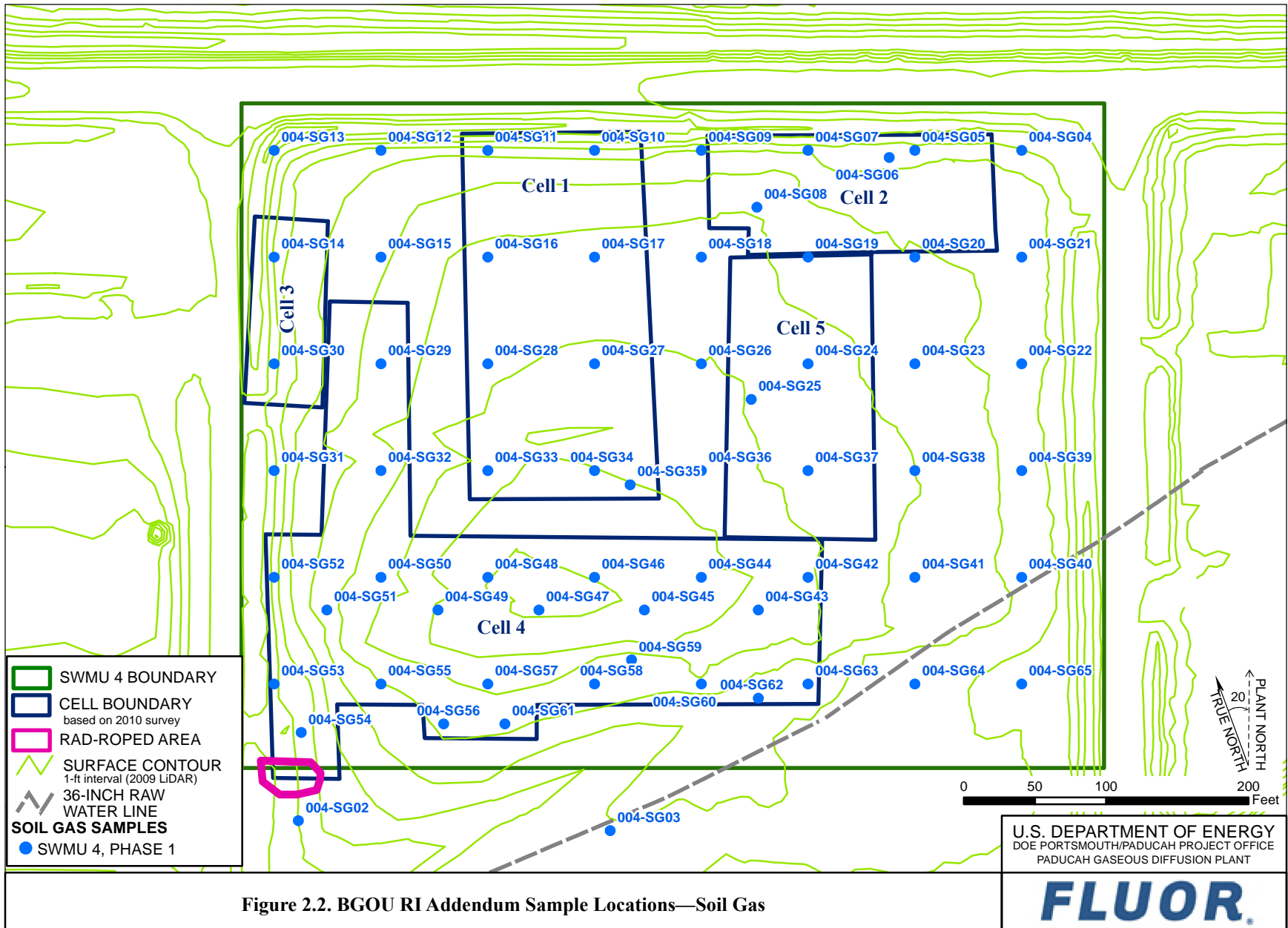

Figure 2.2. BGOU RI Addendum Sample Locations—Soil Gas

- #7—The depth of the water table at SWMU 4 is uncertain. Specifically, is the buried material at SWMU 4 submerged in water?
- #8—It is uncertain whether the bedding materials surrounding the raw water pipe in the southeastern portion of the SWMU have been impacted by site constituents and act as a preferential pathway for migration outside of the SWMU.

From March 19, 2013, to April 9, 2013, 22 borings were advanced to a depth of 20 ft bgs using direct push technology (DPT). These borings were sampled to identify VOCs and other COCs in burial cells and in the UCRS inter-cell areas (i.e., sample locations not located within the burial cell boundaries) of SWMU 4. Additionally, these borings were used to observe UCRS water levels.

The locations of the 22 soil borings are shown in Figure 2.3. The locations were selected as follows:

- Twelve borings were placed in predetermined locations specified in the approved Sampling and Analysis Plan (SAP).
- Ten borings were located based upon data collected during Phase I and earlier investigations and agreed upon by the FFA parties as documented in a DOE letter to EPA and KY, dated February 11, 2013 (PPPO-0201780306-13).

Soil samples were collected from 5-ft intervals below grade and sent to a fixed-base laboratory for analysis of VOCs and other COCs. One water sample was planned from each boring. Where sufficient water was available, samples were collected for VOCs, PCBs, and semivolatile organic analytes (SVOAs) (in that order), but not for metals or radiological constituents. Soil samples from the same borehole were available for metals and radiological constituent analysis.

Seven borings were converted to monitoring wells (MWs) to assist in determining the water table depth. Water samples collected from each well and analyzed for VOCs. The locations of the wells are shown in Figure 2.3 and include one in each of the five burial cells and two in undisturbed UCRS soils. Water levels in the MWs were measured monthly for one year. Well construction records are included in Appendix A.

Evidence of the clay cap was found in 14 of the 22 soil borings as shown in Figure 2.3. Where present, the thickness of the clay cap varied from 0.2 ft to 0.9 ft. The cap appears to cover most of SWMU 4 with the exception of the southwestern portion of Burial Cell 3, the western and southern portions of Burial Cell 4, the western-central portion of Burial Cell 5, and the southeastern portion of SWMU 4.

Pursuant to the approved Work plan, a test pit was excavated in each of the five burial cells with two test pits being excavated in Burial Cell 4 due to its size and the fact that Burial Cell 4 appears to be associated with the highest VOC concentrations in both soil and groundwater based on the historical investigation data. Excavation of the test pits is described as a Phase II activity because of the depth interval in question; however, chronologically, the pits were excavated at the end of Phase V (January 29, 2016, to March 8, 2016) due to the logistical complexities associated with excavation. Phases I–IV data were used to select locations of the test pits. The test pits were excavated using a track excavator. Test pit size was approximately 5-ft wide by 10-ft long. Each test pit reached the base of buried debris. Test pit depth ranged from 8 to 25 ft bgs. Soil samples were taken from the base of each test pit. Water samples were collected from 4 of the 6 test pits; Test Pit 1 and Test Pit 3 were dry at their bases (18 and 16 ft bgs, respectively). In addition to these base-of-pit samples, material of interest encountered prior to reaching the base of some pits was collected at the request of EPA and Kentucky. Some of the materials of interest

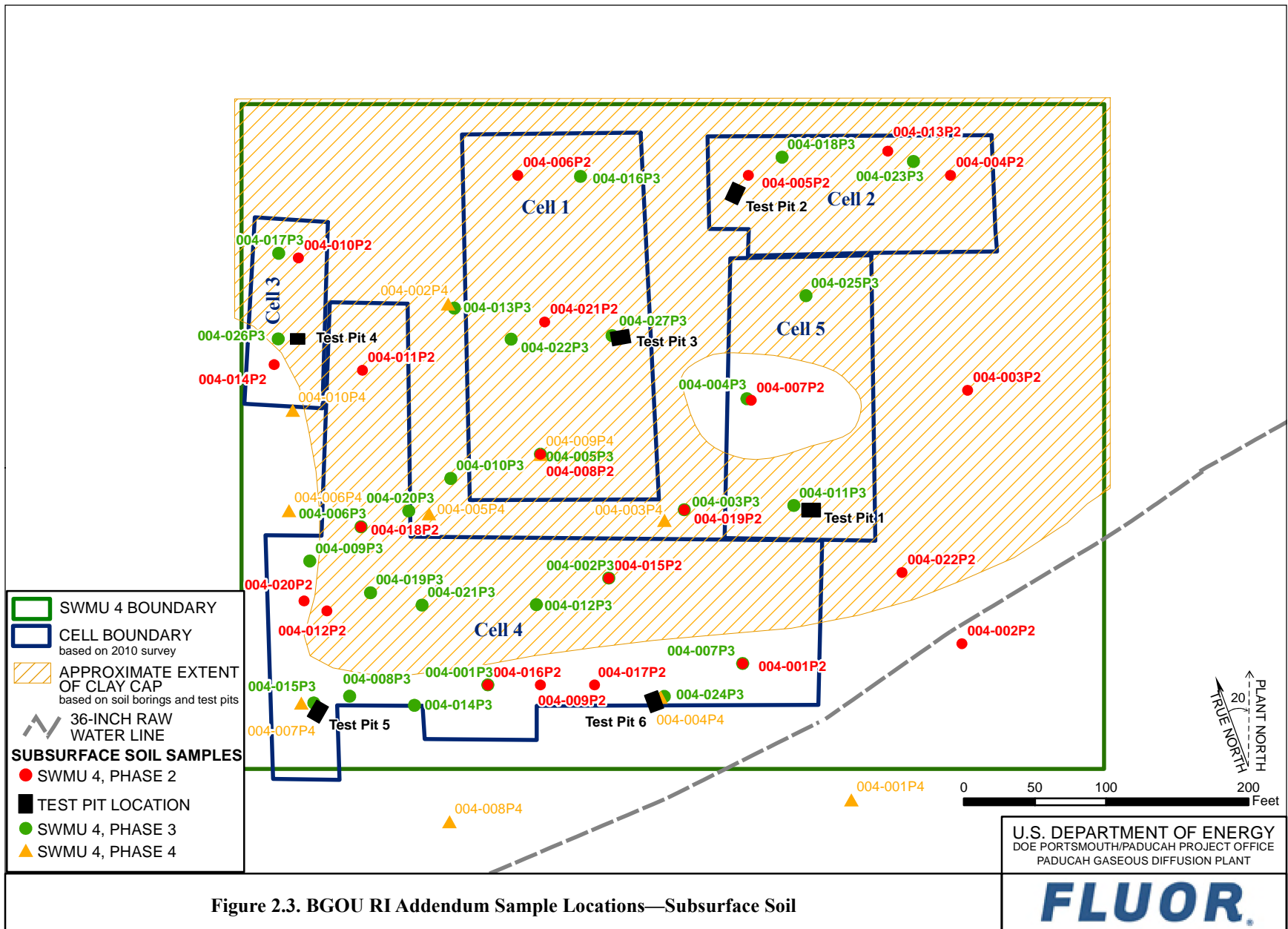

Figure 2.3. BGOU RI Addendum Sample Locations—Subsurface Soil

later were sampled for laboratory analysis. A wide variety of debris was encountered in the test pits, most commonly scrap metal in a range of shapes and sizes, but glass, wood, concrete, and other general construction and industrial debris was encountered. Appendix A of this document contains additional test pit information, including a pit location map, a log of materials of interest collected and sampled, and data summary tables.

### **2.1.3 Phase III**

Phase III was implemented to support the following data gaps.

- #2—There are insufficient data at SWMU 4 to determine the extent and mass of TCE contamination with sufficient accuracy to effectively and efficiently complete a remedial design for TCE in the UCRS (i.e., soils from ground surface to the top of the RGA not identified as burial cells).
- #5—There are insufficient data at SWMU 4 to determine the extent and mass of COCs other than TCE with sufficient accuracy to effectively and efficiently select and design a remedy for the UCRS (i.e., not burial cells or geophysical anomalies).

Phase III of the investigation focused on the UCRS at depths ranging from 20 ft bgs to the top of the RGA (approximately 60 ft bgs). Between May 13, 2013, and September 29, 2014, 27 borings were installed using DPT. The first 11 Phase III boring locations were selected jointly by FFA parties in April and May 2013 using the results of Phase I, II, and earlier investigations. Sixteen borings requested by EPA and KDEP in letters dated February 4, 2014, and February 7, 2014, were selected to (1) delineate the high TCE concentration area (defined as  $> 75 \mu\text{g}/\text{kg}$ ) in the Burial Cell 4 area, and (2) rule out high concentration under cells 1, 2, 3, and 5. Soil samples were collected from the borings at 10-ft depth intervals and sent to a fixed-base laboratory for analysis. All samples were analyzed for VOCs; additionally, the shallowest and the deepest sample from each borehole were analyzed for other COCs.

### **2.1.4 Phase IV**

Phase IV was implemented to support resolution of data gap #3. There are insufficient data at SWMU 4 to determine the extent and mass of TCE source term with sufficient accuracy to effectively and efficiently complete a remedial design for source term in the RGA.

From May 28, 2015, to July 10, 2015, ten borings were installed to the top of the McNairy Formation (total depth of approximately 105 ft). In the initial boring, samples were collected using a DPT rig to a depth of 90 ft bgs, after which the equipment could go no deeper; at that point, the drill method for Phase IV was changed to hollow-stem auger. On December 19, 2014, the FFA parties jointly selected the locations of the initial seven borings; on July 1, 2015, the parties jointly selected the final three locations. The locations of these borings are shown in Figure 2.4.

Borings were installed adjacent to the burial cell (as defined by geophysical results) to avoid penetration of the burial cells and to prevent creation of a migratory conduit into the RGA for potential COCs potentially held up in the cells. In borings near the historically elevated groundwater TCE results (i.e., 004-001P4, 004-003P4, 004-005P4, and 004-006P4), water samples were collected or attempted every 5 ft within the RGA and analyzed for VOCs and Tc-99. In borings farther from the historically elevated groundwater TCE results (i.e., 004-002P4, 004-004P4, 004-007P4, 004-008P4, 004-009P4, and 004-010P4), water samples were collected or attempted every 10 ft within the RGA and analyzed for VOCs and Tc-99. In all borings, soil samples were collected, or attempted, at the top of the RGA and the top of the McNairy and analyzed for VOCs and Tc-99.

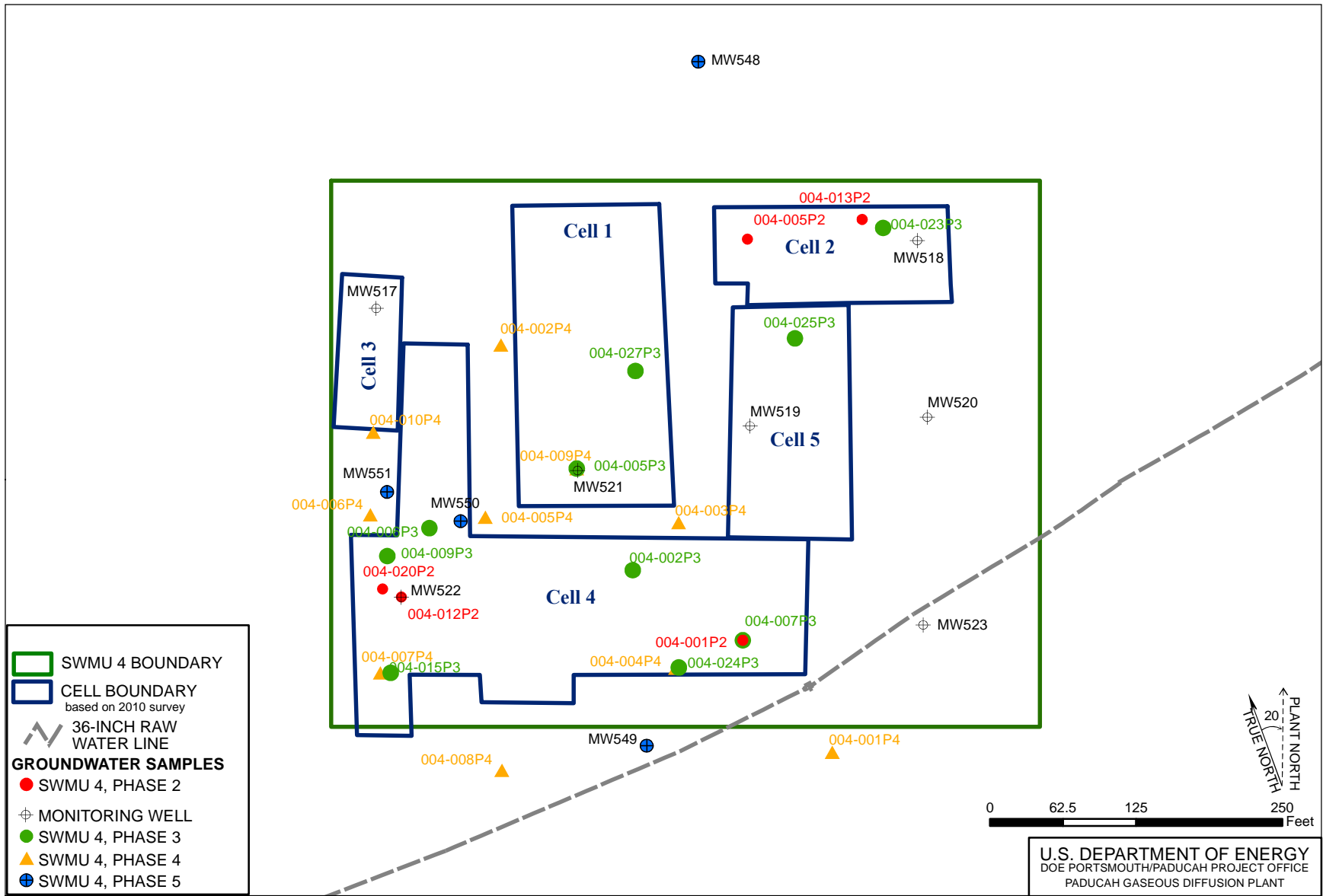

Figure 2.4. BGOU RI Addendum Sample Locations—Groundwater

### 2.1.5 Phase V

Phase V was implemented to support closure of the following data gaps.

- #3—There are insufficient data at SWMU 4 to determine the extent and mass of TCE source term with sufficient accuracy to effectively and efficiently complete a remedial design for source term in the RGA.
- #9—Hydraulic conductivity of the RGA under SWMU 4, as a measure of groundwater velocity and flow direction, is uncertain.

Four RGA MWs were installed and sampled (Figure 2.4). The following are the objectives of the locations.

- One RGA well (MW549) was installed upgradient (south) of SWMU 4. This well was completed with 10-ft screens in the upper, middle, and lower RGA. TCE and Tc-99 samples were collected from each of the three zones using passive diffusion bags and hydrosleeves to determine the vertical distribution of contaminants upgradient within the RGA.
- Two RGA wells (MW550 and MW551) were installed immediately downgradient of the highest historical TCE results. These wells were completed with 10-ft screens in the upper, middle, and lower RGA. TCE and Tc-99 samples were collected from each of the three zones using passive diffusion bags and hydrosleeves to determine the vertical distribution of contaminants downgradient of potential source areas within the RGA.
- One lower RGA well (MW548) was installed downgradient of SWMU 4, adjacent to MW333 (an existing upper RGA well) to determine the vertical distribution of contaminants downgradient of SWMU 4 within the RGA.

Well construction records are included in Appendix A.

## 2.2 ENGINEERING AND DESIGN INFORMATION

This section describes the engineering and design sampling and testing conducted pursuant to Quality Assurance Project Plan Worksheet #17-B in the SAP. Several soil and groundwater properties were determined to be needed to support engineering and design. For soil samples, the parameters included standard penetration tests; grain size data; air permeability; percolation test; and fraction of organic carbon. For groundwater, the parameters included chemical oxygen demand; total organic carbon; dissolved organic carbon; dissolved oxygen; pH; oxidation/reduction potential; temperature; specific conductance; alkalinity; and sulfate, chloride, calcium nitrate, and ferrous iron content. In addition, slug tests were performed on the newly installed RGA MWs to determine the hydraulic conductivity of the RGA in the vicinity of SWMU 4.

The results of the physical tests (i.e., slug test, percolation test, grain size analysis, and air permeability) are provided in Appendix A. Also included in Appendix A are the results of the Phase I passive gas analysis; the results of other chemical analyses are provided in Appendix B.

## 2.3 DEVIATIONS

Site conditions and equipment limitations necessitated some modifications to the sampling approach. Similarly, locations and quantity of sampling locations were, in limited instances, changed based on the laboratory results from early in the investigation. These departures were communicated among the FFA parties and agreed to before implementation. Departures from the originally approved SAP that occurred during Phases I, II, and III of the investigation were rectified and incorporated in the approved R3 revision of the SAP (DOE 2014). Departures from this final approved SAP that occurred during Phases IV, V, and the test pit portion of Phase II are summarized in Table 2.1.

**Table 2.1. Summary of Deviations from the SAP**

	<b>SAP Specification</b>	<b>Actual Field Implementation</b>	<b>Rationale for Deviation</b>	<b>Related FFA Correspondence</b>
<b>Phase II</b>	Collect one soil and one water sample at the base of each pit.	A) Two of the six test pits were dry at the base; therefore, no water samples were collected in these two pits. B) Eight samples collected from the test pits prior to reaching the base.	A) N/A B) After two of the first three test pits were dry at the base, KDEP requested that any water or material of interest encountered prior to reaching the base be collected for possible analysis.	A) N/A B) KDEP letter dated February 2, 2016, (KY8-890-008-982).
	Excavation of a test pit will be suspended if significant water inflow is detected (i.e., if water prevents observation of the base of the excavation).	Excavation continued on four test pits after water inflow prevented observation of the base of the excavation.	The equipment operator could “feel” debris in the base of the pit so excavation continued to (1) determine total depth of buried debris and (2) observe debris after it was lifted out of the water.	During work planning teleconferences, KDEP had expressed concern that the SAP specification regarding water inflow suspending excavation could unduly limit gathering of information.
<b>Phase IV</b>	Advance Phase IV borings hollow-stem auger or roto-sonic.	One boring was advanced with a DPT; however, flowing sands in the RGA caused multiple failures in the DPT drilling and sampling equipment that outweighed the benefits of lower waste production.	To reduce investigative-derived waste.	Discussion on January 7, 2015; and DOE letter (PPPO-02-2745728-15) dated February 13, 2015.
	Water samples were to be collected every 5 ft in the RGA.	Water samples were collected every 5 ft in 4 of the 10 borings and every 10 ft in the 6 of the 10 borings.	Flowing sands in the RGA made water sample collecting extremely time consuming and samples were extremely turbid. So the sampling interval was lengthened in 6 borings not near the high TCE concentration area.	April 21, 2015, discussions with KDEP and follow-up record of conversation transmitted via e-mail on May 26, 2015.



**Table 2.1. Summary of Deviations from the SAP (Continued)**

	<b>SAP Specification</b>	<b>Actual Field Implementation</b>	<b>Rationale for Deviation</b>	<b>Related FFA Correspondence</b>
<b>Phase IV</b>	Water samples to be collected after measured geochemical parameters stabilized.	Water samples were collected after purging one volume of annulus water (below the packer in the hollow stem augers).	Results from Phase IV Boring #1 showed that water quality parameters other than turbidity stabilized quickly (within 6 minutes and after less than 2 gal of water).  Turbidity levels were too high for effective use of the water quality meters.	April 21, 2015, discussion between DOE and KDEP followed by a June 9, 2015, e-mail from DOE contractor (LATA Kentucky) to DOE, EPA, and KDEP.
<b>Phase V</b>	One well was to be installed upgradient of SWMU 4 and completed in the middle RGA.	The upgradient well was completed with three 10-ft screens in the upper, middle, and lower RGA.	To determine the vertical distribution of contaminants within the RGA using passive diffusion bags and hydrosleeves.	Web-based conference call September 21, 2015.
	A three-well cluster (upper, middle, and lower RGA well) was to be installed immediately downgradient of the highest historical TCE results.	Two wells, separated horizontally and each with three 10-ft screens in the upper, middle, and lower RGA, were installed immediately downgradient of the highest historical TCE results.	To collect contaminant data over a greater vertical and horizontal range, passive diffusion bags and hydrosleeves were used.	Web-based conference call September 21, 2015.
	PAD-ENM-0069, <i>Monitoring Well and Associated Infrastructure Installation</i> , was cited in the list of standard operating procedures (SOP). Prepacked well screens are not depicted in the SOP monitoring well drawing.	Prepacked well screens were used in the RGA monitoring wells constructed during Phase V as allowed under 401 KAR 6:350, Monitoring well construction practices and standards.	Flowing formation sands were preventing use of standard, engineered sand pack as depicted in the SOP.	Discussions held on December 7, 2015. The discussion is documented in a KDEP e-mail dated December 7, 2015.

**Table 2.1. Summary of Deviations from the SAP (Continued)**

	<b>SAP Specification</b>	<b>Actual Field Implementation</b>	<b>Rationale for Deviation</b>	<b>Related FFA Correspondence</b>
<b>Phase V</b>	Microbial Community	No analysis for microbial community was conducted.	No radiological licensed laboratory could be located that performs this analysis. The analysis was identified in the QAPP (Worksheet #17) as water sample for design and engineering purposes. If microbial information is needed for engineering or design purposes, and a qualified lab can be located, then samples can be collected from the wells installed during the investigation.	None.

## 2.4 QUALITY ASSURANCE/QUALITY CONTROL

QC was monitored throughout the investigation process. QC included field sampling, laboratory analysis, and data management. This section describes QC for the SWMU 4 supplemental investigation.

### 2.4.1 Field QC

Field QC samples were collected to assess data quality. Appendix B provides the data from the field QC samples in a searchable format on compact disk. Table 2.2 lists the QC samples collected during the SWMU 4 investigation. The target frequency of collection for QC samples for the project was 1 in 20 for equipment rinseates, field blanks, and field duplicates. Trip blanks were collected at a frequency of one per sample cooler that contained VOC samples. The frequency for equipment rinseates and field blanks is slightly lower than target because the total number of samples includes samples analyzed by field screening methods (i.e., XRF and PCB test kits). In accordance with the BGOU Work Plan Addendum, equipment rinseates and field blanks were not planned for these samples (DOE 2014).

**Table 2.2. Summary of SWMU 4 Investigation QC Sampling**

<b>Sample Type</b>	<b>Number of Samples</b>
<i>Samples Analyzed by Field Laboratory</i>	
Soil	154
Field Duplicates	8
Soil Gas	65
Field Duplicates	4
<i>Samples Analyzed by Fixed-Base Laboratory</i>	
Soil Samples	240
Field Duplicates	14
Groundwater Samples	102
Field Duplicates	8
Field Blanks	20
Equipment Rinseates	19
Trip Blanks	73

## 2.4.2 Laboratory QC

The USEC Paducah laboratory, ALS Laboratory Group, TestAmerica Laboratories, and General Engineering Laboratories performed the laboratory analyses of soil and groundwater samples for this investigation. The laboratories were contracted through the Sample Management Office and are DOE/CAP-audited and Nuclear Regulatory Commission-licensed. Approved SW-846 methods were used for all samples, except those parameters for which other methods are necessary. Level C and Level D data packages were provided along with electronic data deliverables (EDDs).

The following data qualifiers were used for reporting fixed-base laboratory results:

### Inorganic Analysis

- \* Duplicate analysis was not within control limits.
- B This flag is used when the analyte is found in the associated blank as well as in the sample.
- J Indicates an estimated value.
- N Spiked sample recovery was not within control limits.
- U The analyte was analyzed for, but not detected.
- X Other specific flags may be required to properly define the results.

### Organic Analysis

- B This flag is used when the analyte is found in the associated blank as well as in the sample.
- E This flag identifies compounds whose concentrations exceed the calibration range of the gas chromatograph (GC)/matrix spike (MS) instrument for that specific analysis.
- J Indicates an estimated value. This flag is used under the following circumstances: (1) when estimating a concentration for tentatively identified compounds where a 1:1 response is assumed and (2) when the mass spectral and retention time data indicate the presence of a compound that meets the pesticide/PCB identification criteria, and the result is less than the contract-required quantitation limit, but greater than zero.
- N Applied to tentatively identified compound results that are reported as specific compounds based on a mass spectral library search.
- U Indicates compound was analyzed for, but not detected.
- X Other specific flags may be required to properly define the results.
- Y Indicates MS/MS duplicate (MSD) recovery and/or relative percent difference (RPD) failed to meet acceptance criteria.

### Radionuclide Analysis

- B Method blank not statistically different from sample at 95% level of confidence.
- T Tracer recovery is < 20% or > 105%.
- U Indicates compound was analyzed for, but not detected.
- X Other specific flags may be required to properly define the results.

Precision, accuracy, and completeness objectives were presented in Section 6 of the BGOU Work Plan Addendum (DOE 2014). An assessment of these objectives for laboratory analytical data was performed. The results of this assessment are provided in Table 2.3. Based on data verification, validation, and assessment, laboratory analytical data has been determined to be usable and to meet the DQOs.

**Table 2.3. QA Assessment for Laboratory Measurements of RI Data**

Parameter	Method	Matrix	Precision	Accuracy	Completeness
VOCs	SW-846 8260	Soil	89%	65%	100%
		Water	98%	89%	100%
Semivolatile organic compounds (SVOCs)	SW-846 8270	Soil	97%	51%	100%
		Water	97%	36%	100%
Metals	SW-846 6010, 6020, and 7000 series	Soil	88%	84%	100%
		Water	99%	87%	100%
PCBs	SW-846 8082	Soil	94%	84%	100%
		Water	95%	68%	100%
Radionuclides	Alpha and gamma spectroscopy and Liquid scintillation	Soil	100%	90%	100%
		Water	97%	100%	100%

**Precision** refers to the level of agreement among repeated measurements of the same characteristic, usually under a given set of conditions. To determine the precision of the laboratory analysis, a routine program of replicate analyses is performed. The absolute difference between the two values calculated is referred to as the RPD. Precision was determined for this investigation by reviewing laboratory-applied qualifiers that pertain to laboratory duplicates over all analyses. QA objectives for precision given in the BGOU Work Plan Addendum are performance based, with RPDs that ranged from 22 to 50% (DOE 2014).

**Accuracy** refers to the nearness of a measurement to an accepted reference or true value. To determine the accuracy of an analytical method and/or the laboratory analysis, a periodic program of sample spiking is conducted. Accuracy for this investigation was determined by reviewing laboratory-applied qualifiers that pertain to laboratory spikes over all analyses. QA objectives for accuracy given in the BGOU Work Plan Addendum are performance based; no concentrations of target compounds greater than the quantitation limits in method/instrument blanks, field blanks, and equipment rinseates.

**Representativeness** is the degree to which discrete samples accurately and precisely reflect a characteristic of a population, variations at a sampling location, or a changing environmental condition. Representativeness is a qualitative parameter and will be achieved through careful, informed selection of sampling sites, drilling sites, drilling depths, and analytical parameters and through the proper collection and handling of samples to avoid interference and minimize contamination and sample loss. This objective was achieved for this investigation by evaluating field condition before and during the data acquisition process to ensure that the most representative sample set possible was collected.

**Completeness** is a measure of the percentage of valid, viable data obtained from a measurement system compared with the amount expected under normal conditions. The goal of completeness is to generate a sufficient amount of valid data to satisfy project needs. Completeness is a measure of samples planned to be collected divided by the number of sample results that were rejected. For this investigation, the completeness objective was 90% (DOE 2014). All soil and water samples targeted for collection during this investigation were collected with the exceptions as noted in Section 2.3.

**Comparability** is the extent to which comparisons among different measurements of the same quantity or quality will yield valid conclusions. Comparability was assessed in terms of field standard operating procedures, analytical methods, QC, and data reporting. In addition, data validation assesses the processes employed by the laboratory that affect data comparability.

Historical data also was evaluated for precision and accuracy as described in the BGOU RI report (DOE 2010a). This assessment was performed over all measurements for the projects associated with the

BGOU SWMUs. Multiple laboratories analyzed samples for these projects. The comparison for the precision and accuracy of historical results encompassed the entire historical data set and did not differentiate between projects or laboratories. A summary of this assessment is provided in Table 2.7 of the BGOU RI report (DOE 2010a).

**Sensitivity** is the capability of a method or instrument to discriminate between measurement responses representing different levels of the variable of interest. This is achieved for each analyte using the Method Detection Limit (MDL), Instrument Detection Limit, or by the laboratory Practical Quantitation Limit (PQL). MDLs and PQLs are laboratory-dependent and will be obtained from the analytical laboratory selected to perform work. For this data set, sensitivity was evaluated by reviewing the reporting limits (RLs) received from the laboratory. RLs that exceeded the requested RLs listed on the laboratory statement of work were evaluated during data verification and data assessment. The data collected met the sensitivity established for this project.

### 2.4.3 Data Management QC

The Paducah Project Environmental Measurements System (PEMS) was used to manage field-generated data; import laboratory-generated data; add data qualifiers based on data verification, validation, and assessment; and to transfer data to the Paducah Oak Ridge Environmental Information System (Paducah OREIS). PEMS includes data from point of collection through final data reporting. The system includes field measurements, chain of custody information, laboratory data package tracking, and EDDs. PEMS also includes information for field planning and data evaluation.

All data packages and EDDs received from the laboratory were tracked, reviewed, and maintained in a secure environment. The following information was tracked: project ID, sample delivery group numbers, date received, receipt of EDDs, and comments.

The data verification processes for laboratory data were implemented for both laboratory data packages and EDDs. The data packages were reviewed to confirm that all samples had been analyzed for the requested parameters. Discrepancies were reported to the laboratory and the data validators. As part of a series of internal integrity checks within PEMS, a check was run to identify which of the requested samples and analyses were not received in an EDD. Laboratory data packages were checked to confirm agreement with the associated EDD. Integrity checks in PEMS also were used to check the list of compounds generated by the laboratory to confirm that data were provided for all requested analytes. Discrepancies were reported to the laboratories for responses and/or correction and to the data validators.

Data verification within PEMS included standardization of analytical methods, chemical names and units, as well as checks for holding time violations and detections above background values.

PEMS system requirements included backups, security, change control, and interfacing with other data management systems. PEMS was housed on the Paducah network. System backups were performed following standard Paducah network protocol.

Security of PEMS and data used for the data management effort was considered essential to the success of the project. The security protocol followed by the data management team was consistent with that of the Paducah network. Access to the network is password-protected. Access to PEMS was limited, on an as-needed basis, to the data management personnel. Read-write, graded access to PEMS was limited to the data management team. The data management staff assisted other project members with data needs from PEMS by running requested queries.

A large volume of data was generated during this investigation. To confirm that the data set could be used in the decision making process, the project team performed various checks and reviews during and after the fieldwork to maintain data consistency and identify problem areas. These checks and reviews included electronic verification and manual assessments by the project team, as well as independent validation of fixed-base laboratory data. Over 18,000 records were reviewed during the SWMU 4 data assessment.

Data validation is a process performed for a data set by a qualified individual independent from sampling, laboratory, project management, and other decision making personnel for the project. Data validation is performed in accordance with EPA guidance. In the data validation process, the laboratory adherence to analytical method requirements is evaluated. Data collected for this investigation was validated at a minimum frequency of 10%.

As part of the data review process, findings were qualified as necessary to reflect data validation results. The following qualifiers were assigned by the data validators.

- J Analyte or compound identified; the associated numerical value is approximated.
- UJ Analyte or compound not detected above the reported detection limit, and the reported detection limit is approximated due to quality deficiency.
- = Data were validated; however, no qualifier was added.

### 3. PHYSICAL CHARACTERISTICS OF THE STUDY AREA

The physical and ecological characteristics of PGDP and of SWMU 4 are summarized in Section 3 of the BGOU RI report (DOE 2010a). The hydrogeology of SWMU 4, particularly as it pertains to the identified data gaps, is updated in this section. Additional discussion has been provided related to depth to the water table (Data Gap/DQO #7) and RGA groundwater velocity and flow direction (Data Gap/DQO #9) at SWMU 4.

#### 3.1 SOIL AND GROUNDWATER PROPERTIES

The scope of the BGOU RI focused on contaminant migration in the soils and in the groundwater of the UCRS and RGA flow systems, while the scope of this supplemental investigation was focused more on the extent of contamination at SWMU 4. Appendix A provides the lithologic logs of the boreholes drilled for this investigation. The following discussion updates the general characteristics of the hydrogeology at SWMU 4, based on field information obtained during the supplemental investigation.

Several soil and groundwater properties were determined to support engineering and design. For soil samples, the parameters include grain size data; air permeability; percolation test; and fraction of organic carbon. For groundwater, the parameters include chemical oxygen demand; total organic carbon; dissolved organic carbon; dissolved oxygen; pH; oxidation/reduction potential; temperature; specific conductance; and sulfate, chloride, calcium nitrate, and ferrous iron content.

**Groundwater Geochemistry.** In areas that are not influenced heavily by dissolved contaminants, both UCRS and RGA groundwater tends to be mildly acidic and well buffered. As the groundwater migrates through the UCRS, bicarbonate replaces sulfate as the dominant anion with depth (Clausen et al. 1992; DOE 1997). The dominant cations in both UCRS and RGA water commonly are sodium followed by calcium.

The BGOU RI reported there is uncertainty with regard to the dissolved oxygen in the UCRS at SWMU 4 due to a lack of data. The presence of TCE degradation products in the UCRS at SWMU 4 provides some evidence of low dissolved oxygen at that unit. Table 3.1 provides general geochemical parameters from the groundwater database that includes both historical and BGOU RI Addendum results. Since January 2013, there have been 34 measurements of dissolved oxygen and oxidation/reduction potential in UCRS MWs and borings. The field measurements for dissolved oxygen ranged from 0.74 to 9.58 mg/L, while the oxidation/reduction potential ranged from -204 to 456 millivolts (mV).

**Table 3.1. Summary of Groundwater Geochemical Data for SWMU 4**

<b>Parameter</b>	<b>Units</b>	<b>Frequency of Detection</b>	<b>Minimum Detection</b>	<b>Maximum Detection</b>
<i>UCRS Groundwater</i>				
Chemical Oxygen Demand	mg/L	2/3	28	42
Total Organic Carbon	mg/L	2/3	11	11
Chloride	mg/L	3/3	27.5	172.4
Dissolved Oxygen	mg/L	34/34	0.74	9.58
Oxidation/Reduction Potential	mV	37/37	-204	456
Sulfate	mg/L	3/3	7.8	301.5

**Table 3.1. Summary of Groundwater Geochemical Data for SWMU 4 (Continued)**

<b>Parameter</b>	<b>Units</b>	<b>Frequency of Detection</b>	<b>Minimum Detection</b>	<b>Maximum Detection</b>
<i><b>RGA Groundwater</b></i>				
Chemical Oxygen Demand	mg/L	0/19	N/A	N/A
Total Organic Carbon	mg/L	3/26	0.907	1.58
Chloride	mg/L	27/27	10	64
Dissolved Oxygen	mg/L	248/248	0.57	74.3
Oxidation/Reduction Potential	mv	225/225	-163	698
Sulfate	mg/L	25/27	1.3	36

N/A = not applicable

### 3.2 SWMU 4 HYDROGEOLOGIC INTERPRETATION

**Waste Disposal Background.** SWMU 4 includes five burial cells (Figure 1.3) excavated to a depth of approximately 16 ft to 20 ft for the disposal of various wastes.

**Stratigraphy.** Similar to other nearby burial grounds, the burial cells of SWMU 4 penetrate into the HU1 loess member (predominately silt) of the Upper Continental Deposits and extend to near the base of HU1, at a depth of 15 to 20 ft. Lithologic logs document the presence of the HU2 horizon (silty sand to sandy silt) at an approximate depths of 20 to 40 ft. This, in turn, is underlain by the HU3 silty clay interval down to a depth of 50 ft. The HU4 sand is approximately 10 ft to 15 ft thick at SWMU 4. Sand and gravelly sand members of the Lower Continental Deposits (HU5) extend down to a depth of approximately 100 ft to 110 ft. The underlying McNairy Formation consists of fine sands and clays. Cross sections in the WAG 3 RI report (DOE 2000a) demonstrate the lateral continuity of these units beneath SWMU 4.

**Depth to the Water Table in the UCRS.** The depth to the water table at SWMU 4 was uncertain and identified as a data gap. Seven shallow MWs (MW517 through MW523) were installed to a depth of approximately 20 ft. Figure 3.1 shows the depth to water measured in these MWs and indicates MW518 and MW519 both exhibit a water level less than two ft bgs during the wet season. Figure 3.2 shows the water level elevation measured in these same wells. This figure shows that most of the wells follow a similar seasonal fluctuation with exception of MW519, which has greater fluctuation during the period observed. Figures 3.3 and 3.4 show the UCRS potentiometric surface measured in May 2014 and November 2014, respectively. Both figures indicate a water level high near the middle of SWMU 4 in the vicinity of MW519.

**RGA Groundwater Flow and Hydraulic Potential.** The regional potentiometric surface of the RGA trends north-northeast toward the regional hydraulic base level represented by the Ohio River. The hydraulic potential of the RGA near the center of the plant site averages 328 ft amsl and commonly fluctuates 5 ft over a yearly high-and-low cycle. RGA water levels near the Ohio River are often 10 ft lower. Low pool elevation of the Ohio River north of PGDP is 290 ft amsl (DOE 2010a).

Representative values for hydraulic gradient at PGDP and to the north commonly range between  $10^{-4}$  ft/ft and  $10^{-3}$  ft/ft (DOE 2010a). In the area of the plant, the potentiometric surface is relatively flat throughout the year. The area north of the DOE property boundary tends to be an area of higher hydraulic gradient, except following an extended rise in the Ohio River stage.



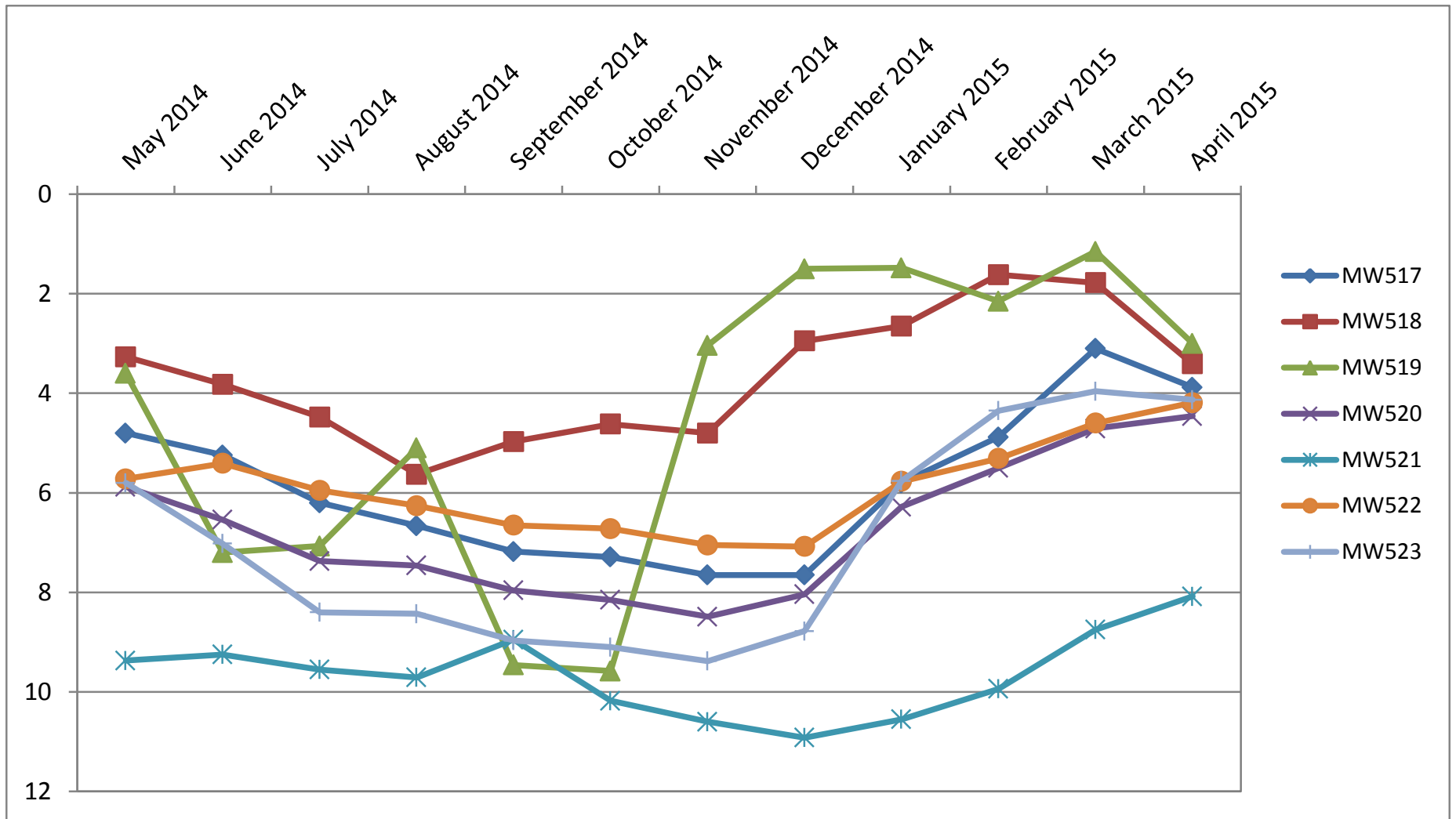

Figure 3.1. Depth to Water Measured in UCRS Monitoring Wells

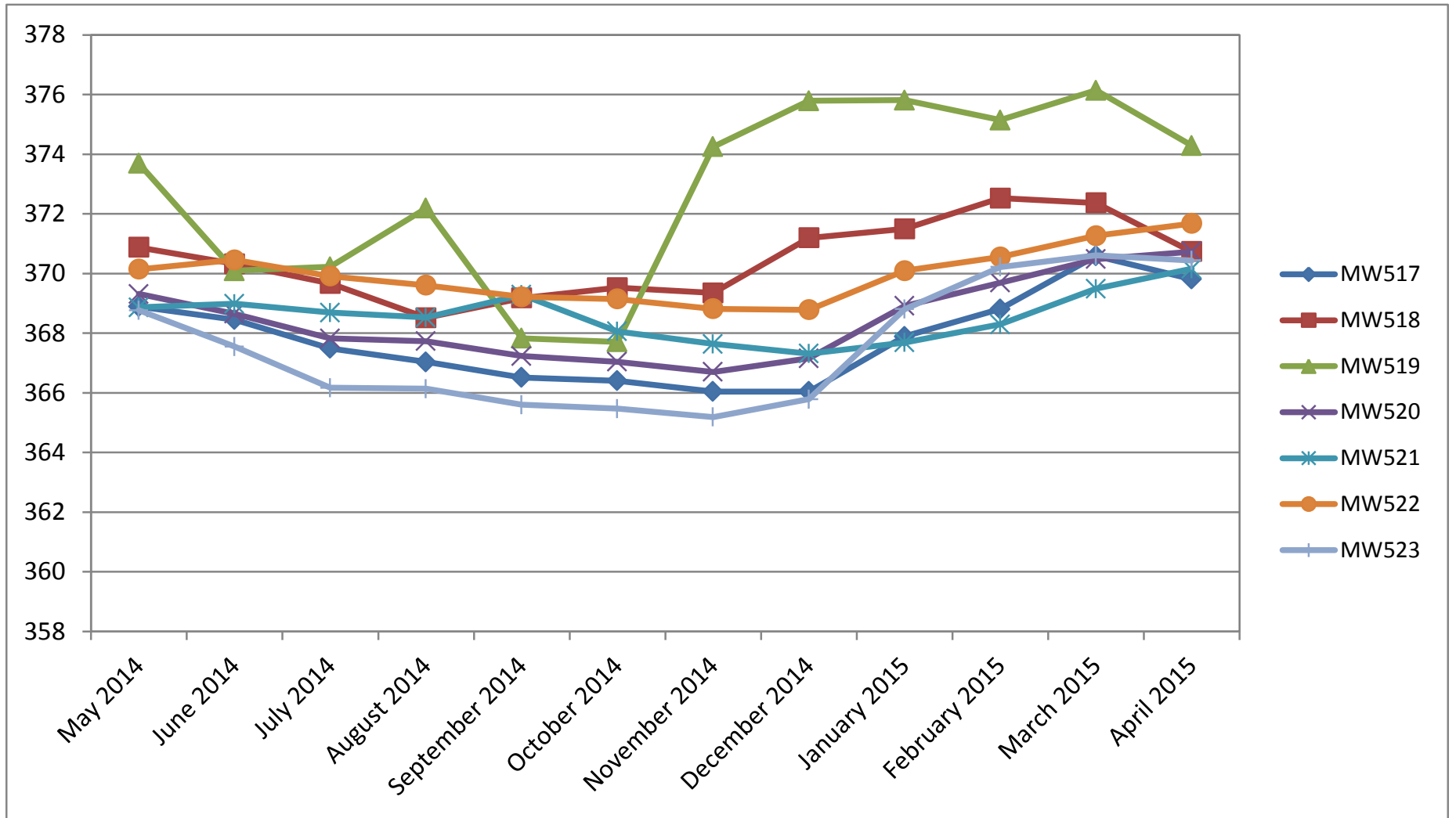

Figure 3.2. UCRS Water Levels Measured in Monitoring Wells

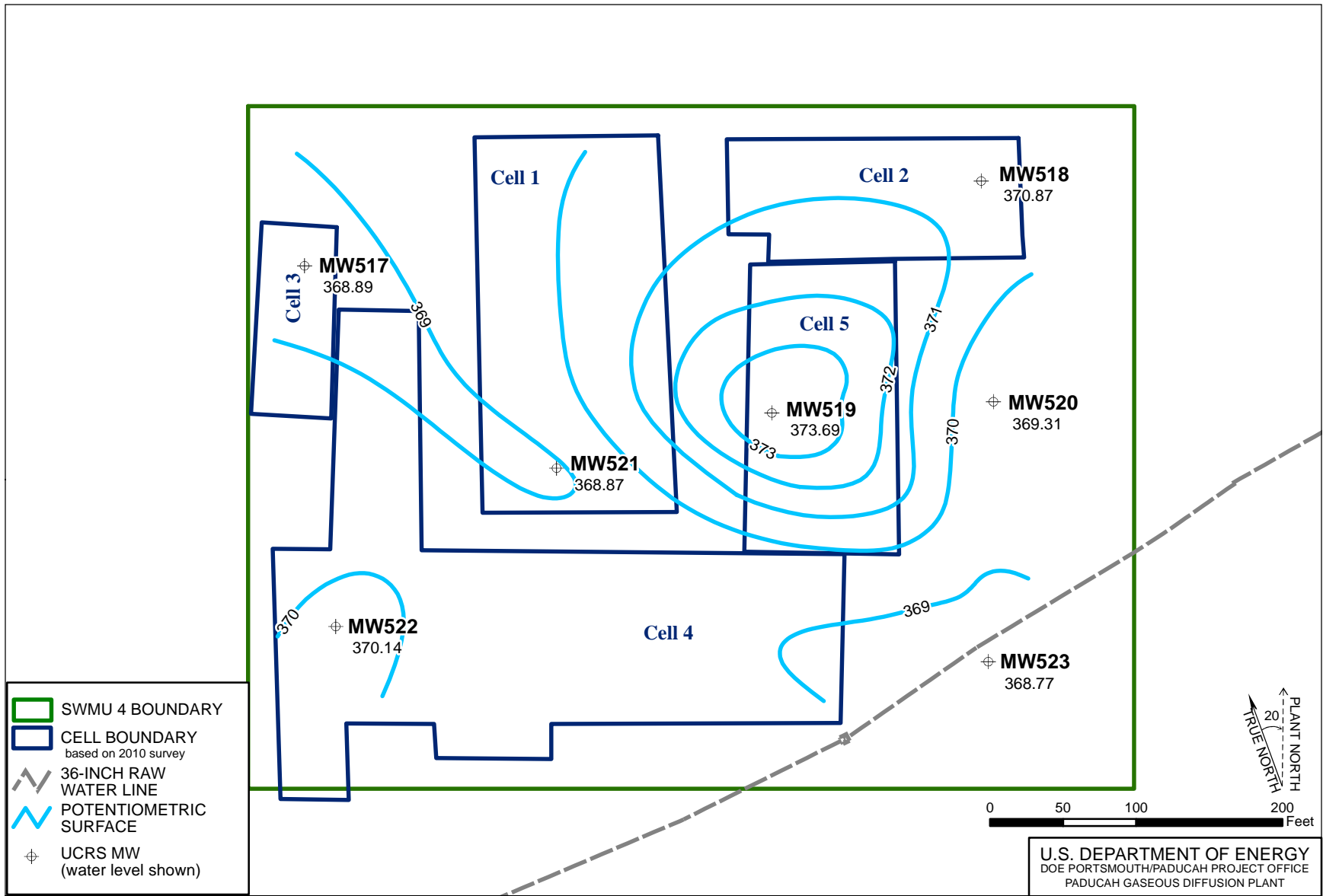

Figure 3.3. UCRS Water Levels at SWMU 4 (May 2014)

U.S. DEPARTMENT OF ENERGY  
DOE PORTSMOUTH/PADUCAH PROJECT OFFICE  
PADUCAH GASEOUS DIFFUSION PLANT



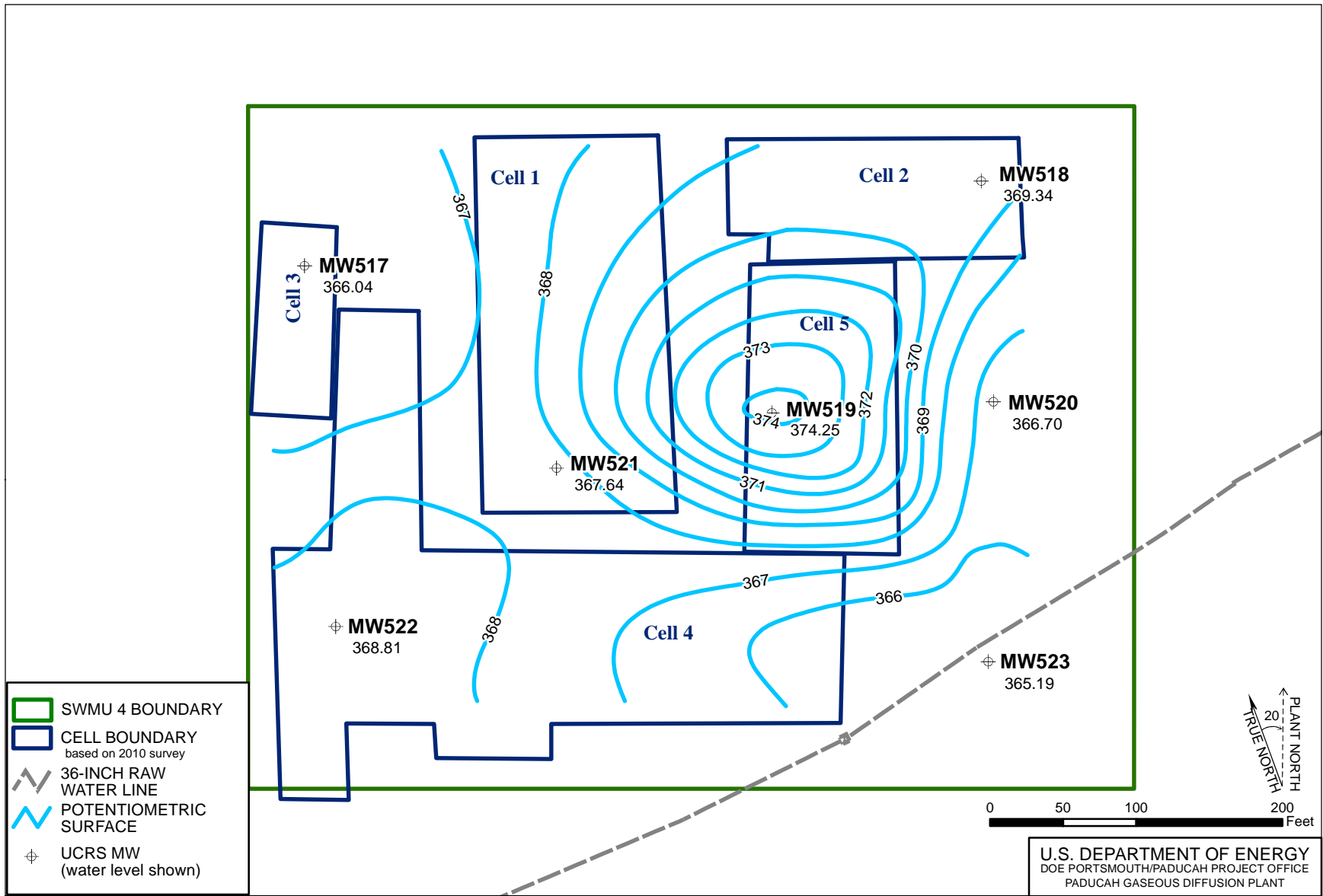

Figure 3.4. UCRS Water Levels at SWMU 4 (November 2014)

U.S. DEPARTMENT OF ENERGY  
DOE PORTSMOUTH/PADUCAH PROJECT OFFICE  
PADUCAH GASEOUS DIFFUSION PLANT



Figure 3.5 shows the potentiometric surface of the RGA measured in February 2016. Based on this depiction of the potentiometric surface, the RGA hydraulic gradient beneath SWMU 4 varies from 0.00026 to 0.00075 ft/ft with an average across the unit of approximately 0.0005 ft/ft. The flow direction, based on this potentiometric map and recent groundwater contaminant maps, is generally northward.

An aquifer test was conducted north of SWMU 4 in the C-404 area in September 1989 (Terran 1990). That test determined that the hydraulic conductivity of the RGA in the C-404 area ranges between 53 and 107 ft/day. Slug tests were performed on the four new RGA MWs at SWMU 4 (MW548–MW551) with the results being typically less than 50 ft/day. These values are low for a gravel aquifer, which may be due to slug tests being extremely sensitive to near-well conditions (e.g., filter pack and well bore); large in-well storage typical of monitoring wells; and formation damage (skin damage) that is not corrected during well development. However, the hydraulic conductivity values may be representative for this area of the RGA. The PGDP sitewide groundwater model uses a hydraulic conductivity of 1,046.5 ft/day at SWMU 4 (PRS 2010), which is approximately 10 times greater than the value for the C-404 area and much greater than the slug test results. Table 3.2 provides a range of groundwater velocities based on a range of hydraulic gradients and hydraulic conductivities. The average velocity ranges from 0.03 to 2.25 ft/day, calculated using the range of gradients and conductivities. The average RGA groundwater flow velocity in other areas of the site with contaminant plumes is generally 1 to 3 ft/day. Because the SWMU 4 slug test data provide hydraulic conductivity values in the lower range for the RGA, the FS will consider a wider range of uncertainty surrounding hydraulic conductivity to evaluate remedial alternatives adequately.

### **3.2.1 SWMU 4 Hydrogeologic Conceptual Model**

SWMU 4 consists of below ground burial cells into which various PGDP wastes were placed and covered with soil. Incomplete soil coverage or cross-contamination between the waste and cover soil could result in contaminants from the waste being exposed at the ground surface. Once at the surface, the most likely pathway of contaminant migration would be surface water runoff (i.e., precipitation). Infiltration of water (i.e., precipitation) descending through the buried waste has mobilized contaminants within the waste resulting in contaminated subsurface soil. Additionally, TCE, a DNAPL, could migrate independently of infiltrating water and, like buried waste and contaminated soil, could serve as a source of contamination. For SWMU 4, the evidence of DNAPL presence is very high based on dissolved TCE concentrations (greater than one percent TCE solubility) in UCRS groundwater. The area of higher TCE levels in the upper RGA is suggestive of a source of DNAPL contamination in the UCRS soils underlying the burial grounds. The dissolved TCE in UCRS groundwater and subsurface soil samples indicate the primary TCE contamination occurs near Burial Cell 4. Once mobilized by infiltrating water, the most likely pathway of contaminant migration would be downward through the UCRS soils, ultimately reaching the RGA. Once contaminants reach the RGA, the rate of migration increases as a result of the higher hydraulic conductivity of the RGA sands and gravels (compared to the hydraulic conductivity of the UCRS silt and clay). Regional groundwater flow is generally north to northwest in the RGA. Beneath SWMU 4, the potentiometric surface of the RGA is relatively flat. Recent maps of the potentiometric surface indicate the RGA flow direction is generally northward. Some lateral movement of contaminants occurs in the UCRS, but these pathways are known to be limited. Based on this conceptual model, any contamination resulting from buried waste at SWMU 4 would be expected to be concentrated in the soils and groundwater of the UCRS immediately within and beneath the burial cells with little lateral dispersion of contamination in the UCRS.

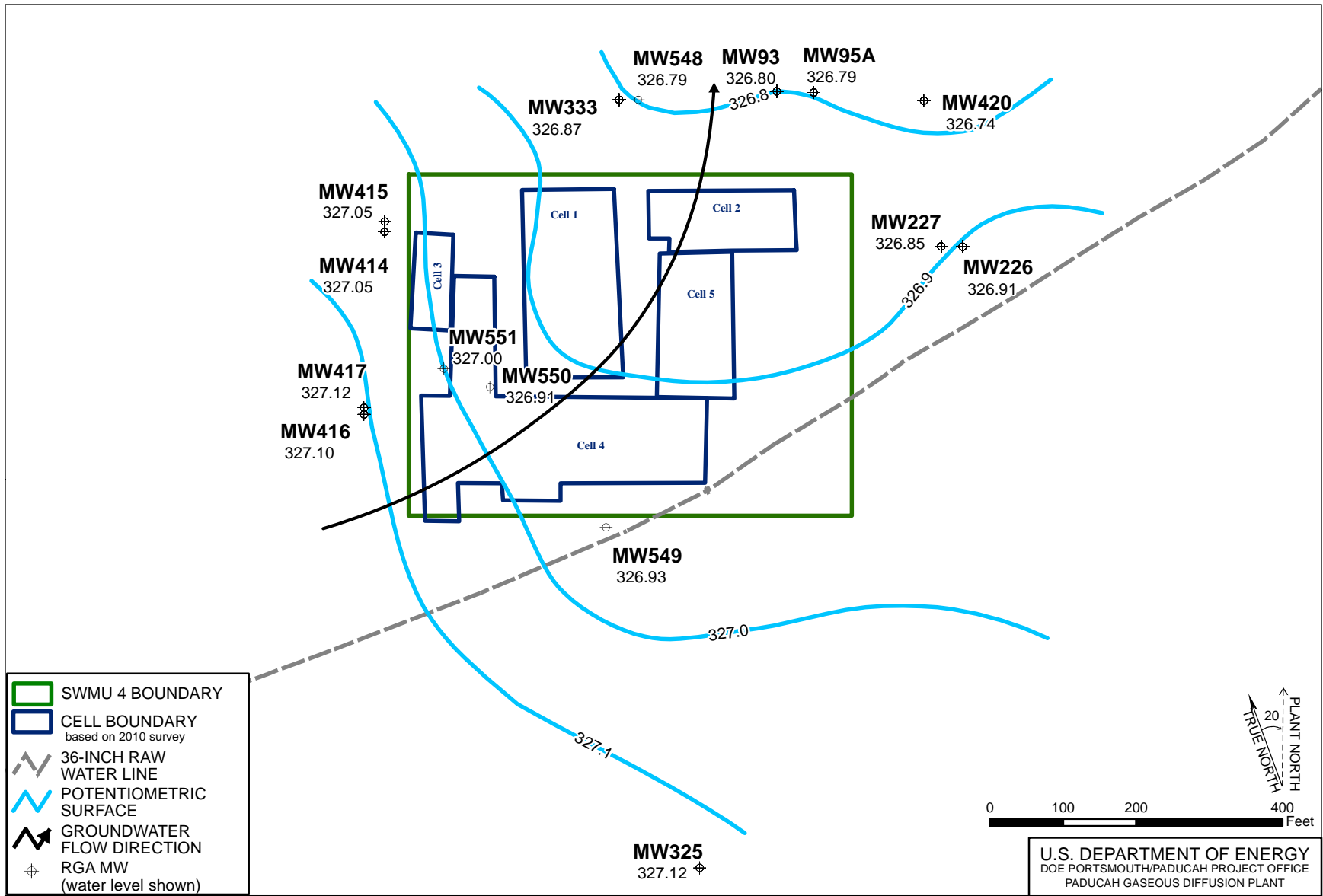

Figure 3.5. RGA Water Levels at SWMU 4 (February 2016)

U.S. DEPARTMENT OF ENERGY  
DOE PORTSMOUTH/PADUCAH PROJECT OFFICE  
PADUCAH GASEOUS DIFFUSION PLANT



**Table 3.2. Estimated Groundwater Flow Velocity at SWMU 4**

<b>RGA k =15.7 ft/day (Based on SWMU 4 slug test average value)</b>			
	<b>i (ft/ft)</b>	<b>q (ft/day)</b>	<b>v (ft/day)</b>
Minimum gradient (i)	2.63E-04	0.004	0.02
Maximum gradient (i)	7.50E-04	0.012	0.05
<b>Average gradient (i)</b>	<b>5.37E-04</b>	<b>0.008</b>	<b>0.03</b>
<b>RGA k =107 ft/day (Based on C-404 aquifer test maximum value)</b>			
	<b>i (ft/ft)</b>	<b>q (ft/day)</b>	<b>v (ft/day)</b>
Minimum gradient (i)	2.63E-04	0.03	0.11
Maximum gradient (i)	7.50E-04	0.08	0.32
<b>Average gradient (i)</b>	<b>5.37E-04</b>	<b>0.06</b>	<b>0.23</b>
<b>RGA k =1047 ft/day (Based on modeled values at SWMU 4)</b>			
	<b>i (ft/ft)</b>	<b>q (ft/day)</b>	<b>v (ft/day)</b>
Minimum gradient (i)	2.63E-04	0.28	1.10
Maximum gradient (i)	7.50E-04	0.79	3.14
<b>Average gradient (i)</b>	<b>5.37E-04</b>	<b>0.56</b>	<b>2.25</b>
q = k*i		v = q/n	
Where		where	
q = specific discharge (per unit area)		v = average linear velocity	
k = hydraulic conductivity		q = specific discharge	
i = hydraulic gradient (from potentiometric map, Figure 3.5)		n = porosity (assumed to be 25%)	

**THIS PAGE INTENTIONALLY LEFT BLANK**



## 4. NATURE AND EXTENT OF CONTAMINATION

This section provides an evaluation of data from the SWMU 4 RI along with historical data from previous investigations to determine the overall nature and extent of contamination at SWMU 4 to address related data gaps.

This section presents summary tables containing analytical results (summary tables show results above screening levels) and figures depicting the locations of the samples. In addition, the text of this section summarizes notable results from the screening process. Conclusions from the screening evaluation and a discussion of how the results help fill identified data gaps are found in Section 7.2.

### 4.1 DATA PROCESSING AND SCREENING

The primary objective of the data processing and screening was to identify potential site-related contaminants and delineate the extent of the potential contaminants. To achieve this goal, the analytical soil results of this investigation were compared to PGDP surface and subsurface soil background concentrations and applicable screening values. The historical data were initially screened during the BGOU RI (DOE 2010a). For this report, the historical and recently collected data were combined for evaluation against current screening levels. Appendix B provides a report of analytical results for samples collected during this investigation and the historical data set in a searchable dataset on compact disk.

Separate vertical boundaries and media designations were established for defining the nature and extent of contamination at SWMU 4 and for estimating potential risk at the SWMU. These boundaries are as follows:

- **Surface Soils.** The vertical extent of surface soils with respect to nature and extent was 0–1 ft bgs. These soils were screened against surface background values and groundwater protection screening values for the UCRS [i.e., a dilution attenuation factor (DAF) of 1] and for the Regional Gravel Aquifer (RGA) (i.e., a DAF of 58). Additionally, surface soils were screened against industrial worker no action levels (NALs)/action levels (ALs) and excavation worker NALs/ALs.
- **Subsurface Soils.** The vertical extent of subsurface soil with respect to nature and extent was 1–60 ft bgs. These soils were screened against subsurface background values and groundwater protection screening values for the UCRS and for the RGA. Subsurface soils from 1–20 ft bgs also were screened against excavation worker NALs/ALs for nature and extent comparison. [The Risk Methods Document lists 0–16 ft bgs for comparison to the excavation worker (DOE 2015); however, the maximum depth of 20 ft is used in order to fully encompass the maximum depth of burial.] Potential risk was estimated for the excavation worker using surface and subsurface soils (0–20 ft bgs). Soils deeper than 60 ft bgs are not screened against groundwater protection screening values or background because they are within the RGA.
- **Groundwater.** Results from groundwater samples are divided into UCRS, RGA, and McNairy data sets. Groundwater data were screened against residential NALs/ALs and maximum contaminant levels for nature and extent comparison. Additionally, RGA and McNairy data were screened against background values. Potential risks were estimated for the child resident using RGA and McNairy results.

Data processing and screening were conducted as a multiphase process. First, data were screened to eliminate those sample results that were not detected, as qualified by the laboratory or validation. The

retained data then were compared with screening levels (data were independently compared to background and risk-screening levels). Screening levels for surface soil (up to 1 ft depth) consisted of background levels and risk-based NALs and ALs for the industrial worker and excavation worker as compiled from the Risk Methods Document (DOE 2015b) (Table 4.1). Screening levels for subsurface soil consisted of background levels (for subsurface soil from 1 ft to 60 ft depth) and risk-based NALs and ALs for the excavation worker (for subsurface soil from 1 ft to 20 ft depth) (Table 4.2). All soil results also were compared to groundwater protection site-specific soil screening levels (SSLs) for the UCRS and RGA [DAFs of 1 and 58 for the UCRS and RGA, respectively, based on maximum contaminant levels (MCLs), where available] (DOE 2015b). Table 4.1 includes the surface soil results compared to the groundwater protection SSLs, and Table 4.2 includes the subsurface soil results [from 1 ft depth to base of the UCRS (considered to be 60 ft depth for screening)] compared to the groundwater protection SSLs.

In order to evaluate more comprehensively the data for SWMU 4, plutonium-239 data were assessed as plutonium-239/240 and uranium-235/236 were assessed as uranium-235. Data summaries use Total PCBs and Total PAHs; individual congeners and carcinogenic PAHs are not included in the summaries (DOE 2015b). Data tables within this document summarize uranium (metal) and isotopic uranium separately (i.e., the data may not be from the same sample); thus, a correlation between uranium (metal)/uranium (isotopic) data would not be appropriate. Further, total uranium analyzed as a radionuclide (i.e., reported in pCi/g) is not considered in this report because the individual isotopes, uranium-234, uranium-235, and uranium-238, are evaluated.

Groundwater samples with analytes above detection limits were compared to MCLs, if available. They also were compared to risk-based child resident NALs and ALs (Table 4.3). Additionally, background groundwater values for RGA and McNairy samples were used for screening, as applicable (PGDP background levels for water drawn from the RGA and McNairy Formation are provisional values that are subject to change). Background values are unavailable for UCRS groundwater. Seven analytes known to be essential nutrients and known to be toxic only at extremely high concentrations were removed from the selection of contaminants in the groundwater data set. These analytes were calcium, chloride, iodine, magnesium, phosphorus, potassium, and sodium.

## **4.2 SURFACE SOILS**

The surface soil data summary presented in Table 4.4 provides the nature of the contamination in SWMU 4 surface soils and Figures 4.1 through 4.3 illustrate the horizontal extent for various constituents. The summary table is based on all surface soil sample data (0–1 ft bgs) and presents minimum (min), maximum (max), and average (avg) values of the detected results, frequencies of detection (FODs), frequencies of exceedance (FOEs) as compared to screening values shown in Tables 4.1 through 4.3, and the detection limit (DL) range. During the investigation, the data collected consisted of field laboratory (i.e., PCB test kits and metal analysis by XRF) and fixed-base laboratory data analyses. Data quality is described in Appendix B. Of note, the evaluation of the XRF data with fixed-base laboratory data indicates the use of XRF results for iron, lead, nickel, and uranium have good correlation; therefore, the data are reliable for use in determining nature and extent and hot spots. See Appendix B for additional information.

### **Metals**

The following metals were detected in surface soil at concentrations above both background screening levels and the industrial worker NALs: arsenic, chromium, iron, manganese, and uranium. Of those metals, all also exceeded the excavation worker NAL, with the exception of chromium. Mercury exceeded both background and the excavation worker NAL in one sample. Iron was detected above the

**Table 4.1. Screening Values for Surface Soil**

<b>Analysis</b>	<b>Provisional Background<sup>a</sup></b>	<b>Industrial Worker NAL<sup>b</sup></b>	<b>Industrial Worker AL<sup>c</sup></b>	<b>SSL (DAF 1)<sup>d</sup></b>	<b>SSL (DAF 58)<sup>d</sup></b>
<b><i>Inorganics—Metals (mg/kg)</i></b>					
Aluminum	1.30E+04	1.00E+05	1.00E+05	2.99E+03	1.73E+05
Antimony	2.10E-01	9.34E+01	2.80E+03	2.71E-01	1.57E+01
Arsenic	1.20E+01	1.41E+00	1.41E+02	2.92E-01	1.69E+01
Barium	2.00E+02	4.04E+04	1.00E+05	8.24E+01	4.78E+03
Beryllium	6.70E-01	4.50E+02	1.35E+04	3.16E+00	1.83E+02
Cadmium	2.10E-01	6.12E+01	1.84E+03	3.76E-01	2.18E+01
Calcium	2.00E+05	N/A	N/A	N/A	N/A
Chromium <sup>e</sup>	1.60E+01	1.98E+02	1.98E+04	1.80E+05	1.04E+07
Cobalt	1.40E+01	6.87E+01	2.06E+03	2.71E-02	1.57E+00
Copper	1.90E+01	9.34E+03	1.00E+05	4.58E+01	2.65E+03
Iron	2.80E+04	1.00E+05	1.00E+05	3.52E+01	2.04E+03
Lead	3.60E+01	8.00E+02	8.00E+02	1.35E+01	7.83E+02
Magnesium	7.70E+03	N/A	N/A	N/A	N/A
Manganese	1.50E+03	4.72E+03	1.00E+05	2.74E+00	1.59E+02
Mercury	2.00E-01	7.01E+01	2.10E+03	2.90E-02	1.68E+00
Nickel	2.10E+01	4.30E+03	1.00E+05	2.54E+00	1.47E+02
Potassium	1.30E+03	N/A	N/A	N/A	N/A
Selenium	8.00E-01	1.17E+03	3.51E+04	2.60E-01	1.51E+01
Silver	2.30E+00	1.17E+03	3.51E+04	7.84E-02	4.55E+00
Sodium	3.20E+02	N/A	N/A	N/A	N/A
Thallium	2.10E-01	2.34E+00	7.02E+01	1.42E-01	8.26E+00
Uranium	4.90E+00	6.81E+02	2.04E+04	1.35E+01	7.83E+02
Vanadium	3.80E+01	1.15E+03	3.45E+04	8.26E+00	4.79E+02
Zinc	6.50E+01	7.01E+04	1.00E+05	3.73E+01	2.16E+03
<b><i>Organics—PCBs and Semivolatiles (mg/kg)</i></b>					
PCB, Total	N/A	3.05E-01	3.05E+01	7.82E-02	4.54E+00
2-Nitrobenzenamine <sup>f</sup>	N/A	2.91E+02	8.73E+03	7.94E-03	4.61E-01
Acenaphthene	N/A	1.40E+03	4.20E+04	5.07E-01	2.94E+01
Acenaphthylene	N/A	1.40E+03	4.20E+04	5.07E-01	2.94E+01
Anthracene	N/A	6.99E+03	1.00E+05	5.26E+00	3.05E+02
Bis(2-ethylhexyl)phthalate	N/A	5.88E+01	5.88E+03	1.44E+00	8.33E+01
Carbazole	N/A	4.12E+01	4.12E+03	3.63E-02	2.11E+00
Fluoranthene	N/A	9.32E+02	2.80E+04	8.91E+00	5.17E+02
Fluorene	N/A	9.32E+02	2.80E+04	4.98E-01	2.89E+01
Hexachlorobenzene	N/A	5.15E-01	5.15E+01	1.26E-02	7.31E-01
Naphthalene	N/A	1.67E+01	1.61E+03	5.43E-04	3.15E-02
N-Nitroso-di-n-propylamine	N/A	1.18E-01	1.18E+01	8.08E-06	4.69E-04
Pentachlorophenol	N/A	8.91E-01	8.91E+01	1.01E-02	5.87E-01
Phenanthrene	N/A	1.40E+03	4.20E+04	5.07E-01	2.94E+01
Pyrene	N/A	6.99E+02	2.10E+04	1.18E+00	6.82E+01

**Table 4.1. Screening Values for Surface Soil (Continued)**

<b>Analysis</b>	<b>Provisional Background<sup>a</sup></b>	<b>Industrial Worker NAL<sup>b</sup></b>	<b>Industrial Worker AL<sup>c</sup></b>	<b>SSL (DAF 1)<sup>d</sup></b>	<b>SSL (DAF 58)<sup>d</sup></b>
<b>Organics—Volatiles (mg/kg)</b>					
1,1,1-Trichloroethane	N/A	3.58E+03	1.00E+05	7.01E-02	4.07E+00
1,1,2-Trichloro-1,2,2-trifluoroethane	N/A	1.69E+04	1.00E+05	1.38E+01	7.99E+02
1,1,2-Trichloroethane	N/A	6.32E-01	1.90E+01	1.62E-03	9.41E-02
1,1-Dichloroethane	N/A	1.58E+01	1.58E+03	7.81E-04	4.53E-02
1,1-Dichloroethene	N/A	1.00E+02	3.00E+03	2.51E-03	1.46E-01
1,2-Dichloroethane	N/A	2.09E+00	2.09E+02	1.42E-03	8.22E-02
1,2-Dimethylbenzene <sup>e</sup>	N/A	2.81E+02	8.43E+03	1.90E-02	1.10E+00
Acrylonitrile	N/A	1.24E+00	1.24E+02	1.14E-05	6.60E-04
Benzene	N/A	5.31E+00	5.31E+02	2.56E-03	1.48E-01
Bromodichloromethane	N/A	1.30E+00	1.30E+02	2.17E-02	1.26E+00
Carbon tetrachloride	N/A	2.96E+00	2.96E+02	1.94E-03	1.13E-01
Chloroform	N/A	1.39E+00	1.39E+02	2.22E-02	1.29E+00
<i>cis</i> -1,2-Dichloroethene	N/A	4.67E+02	1.40E+04	2.06E-02	1.19E+00
Dichlorodifluoromethane <sup>h</sup>	N/A	3.68E+01	1.10E+03	3.04E-02	1.76E+00
Ethylbenzene	N/A	2.66E+01	2.66E+03	7.85E-01	4.55E+01
<i>m,p</i> -Xylene <sup>i</sup>	N/A	2.54E+02	7.62E+03	9.85E+00	5.71E+02
Tetrachloroethene	N/A	4.00E+01	1.20E+03	2.27E-03	1.31E-01
Toluene	N/A	6.25E+03	1.00E+05	6.92E-01	4.01E+01
Total Xylene <sup>i</sup>	N/A	2.54E+02	7.62E+03	9.85E+00	5.71E+02
<i>trans</i> -1,2-Dichloroethene	N/A	6.51E+01	1.95E+03	2.94E-02	1.71E+00
Trichloroethene	N/A	1.90E+00	5.70E+01	1.79E-03	1.04E-01
Vinyl chloride	N/A	2.06E+00	2.06E+02	6.90E-04	4.00E-02
<b>Radionuclides (pCi/g)</b>					
Americium-241	N/A	5.99E+00	5.99E+02	9.58E-01	5.55E+01
Cesium-137	4.90E-01	1.02E-01	1.02E+01	4.79E-01	2.78E+01
Neptunium-237	1.00E-01	2.29E-01	2.29E+01	5.36E-02	3.11E+00
Plutonium-238	7.30E-02	2.87E+01	2.87E+03	2.19E-01	1.27E+01
Plutonium-239/240	2.50E-02	2.47E+01	2.47E+03	2.13E-01	1.23E+01
Radium-226	1.50E+00	N/A	N/A	N/A	N/A
Technetium-99	2.50E+00	1.20E+03	1.00E+05	7.60E-03	4.41E-01
Thorium-230	1.50E+00	3.39E+01	3.39E+03	1.83E+00	1.06E+02
Uranium-234	1.20E+00	5.53E+01	5.53E+03	4.95E-02	2.87E+00
Uranium-235	6.00E-02	3.40E-01	3.40E+01	4.88E-02	2.83E+00
Uranium-238	1.20E+00	1.60E+00	1.60E+02	4.03E-02	2.34E+00

<sup>a</sup> Surface background values are reported in the Risk Methods Document, Table A.12 (DOE 2015b).

<sup>b</sup> The industrial worker NALs are the lesser of the values for hazard index (HI) of 0.1 and excess lifetime cancer risk (ELCR) of 1E-06 [Risk Methods Document, Table A.4 (DOE 2015b)].

<sup>c</sup> The industrial worker ALs are the lesser of the values for HI of 3 and ELCR of 1E-04 [Risk Methods Document, Table A.1 (DOE 2015b)].

<sup>d</sup> For nonradionuclides, SSLs are from the EPA MCL of Table A.7a, if available. If no EPA MCL was available, SSLs are from PGDP NALs for the Resident. For radionuclides, SSLs are from the 10<sup>-6</sup> values in the Risk Methods Document, Table A.7b (DOE 2015b).

<sup>e</sup> Chromium is assessed as chromium (total).

<sup>f</sup> 2-Nitrobenzenamine also is known as 2-nitroaniline.

<sup>g</sup> 1,2-Dimethylbenzene also is known as *o*-xylene.

<sup>h</sup> Dichlorodifluoromethane also is known as Freon-12.

<sup>i</sup> *m,p*-Xylene and total xylene are assessed as xylene, mixture.

Table 4.2. Screening Values for Subsurface Soil

Analysis	Provisional Background <sup>a</sup>	Excavation Worker NAL <sup>b</sup>	Excavation Worker AL <sup>c</sup>	SSL (DAF 1) <sup>d</sup>	SSL (DAF 58) <sup>d</sup>
<i>Inorganics—Metals (mg/kg)</i>					
Aluminum	1.20E+04	3.26E+04	1.00E+05	2.99E+03	1.73E+05
Antimony	2.10E-01	1.32E+01	3.96E+02	2.71E-01	1.57E+01
Arsenic	7.90E+00	2.52E+00	2.43E+02	2.92E-01	1.69E+01
Barium	1.70E+02	6.47E+03	1.00E+05	8.24E+01	4.78E+03
Beryllium	6.90E-01	6.55E+01	1.97E+03	3.16E+00	1.83E+02
Cadmium	2.10E-01	2.54E+01	7.62E+02	3.76E-01	2.18E+01
Calcium	6.10E+03	N/A	N/A	N/A	N/A
Chromium <sup>e</sup>	4.30E+01	1.34E+03	1.00E+05	1.80E+05	1.04E+07
Cobalt	1.30E+01	9.84E+00	2.95E+02	2.71E-02	1.57E+00
Copper	2.50E+01	1.32E+03	3.96E+04	4.58E+01	2.65E+03
Iron	2.80E+04	2.30E+04	1.00E+05	3.52E+01	2.04E+03
Lead	2.30E+01	8.00E+02	8.00E+02	1.35E+01	7.83E+02
Magnesium	2.10E+03	N/A	N/A	N/A	N/A
Manganese	8.20E+02	7.74E+02	2.32E+04	2.74E+00	1.59E+02
Mercury	1.30E-01	9.86E+00	2.96E+02	2.90E-02	1.68E+00
Nickel	2.20E+01	6.52E+02	1.96E+04	2.54E+00	1.47E+02
Potassium	9.50E+02	N/A	N/A	N/A	N/A
Selenium	7.00E-01	1.64E+02	4.92E+03	2.60E-01	1.51E+01
Silver	2.70E+00	1.64E+02	4.92E+03	7.84E-02	4.55E+00
Sodium	3.40E+02	N/A	N/A	N/A	N/A
Thallium	3.40E-01	3.29E-01	9.87E+00	1.42E-01	8.26E+00
Uranium	4.60E+00	9.83E+01	2.95E+03	1.35E+01	7.83E+02
Vanadium	3.70E+01	1.65E+02	4.95E+03	8.26E+00	4.79E+02
Zinc	6.00E+01	9.86E+03	1.00E+05	3.73E+01	2.16E+03
<i>Organics—PCBs and Semivolatiles (mg/kg)</i>					
PCB, Total	N/A	1.14E+00	1.14E+02	7.82E-02	4.54E+00
2-Nitrobenzenamine <sup>f</sup>	N/A	1.90E+02	5.70E+03	7.94E-03	4.61E-01
Acenaphthene	N/A	1.02E+03	3.06E+04	5.07E-01	2.94E+01
Acenaphthylene	N/A	1.02E+03	3.06E+04	5.07E-01	2.94E+01
Anthracene	N/A	5.09E+03	1.00E+05	5.26E+00	3.05E+02
Bis(2-ethylhexyl)phthalate	N/A	1.91E+02	1.15E+04	1.44E+00	8.33E+01
Carbazole	N/A	1.34E+02	1.34E+04	3.63E-02	2.11E+00
Fluoranthene	N/A	6.78E+02	2.03E+04	8.91E+00	5.17E+02
Fluorene	N/A	6.78E+02	2.03E+04	4.98E-01	2.89E+01
Hexachlorobenzene	N/A	1.67E+00	1.67E+02	1.26E-02	7.31E-01
Naphthalene	N/A	6.62E+01	1.99E+03	5.43E-04	3.15E-02
N-Nitroso-di-n-propylamine	N/A	3.82E-01	3.82E+01	8.08E-06	4.69E-04
Pentachlorophenol	N/A	4.10E+00	4.10E+02	1.01E-02	5.87E-01
Phenanthrene	N/A	1.02E+03	3.06E+04	5.07E-01	2.94E+01
Pyrene	N/A	5.09E+02	1.53E+04	1.18E+00	6.82E+01

**Table 4.2. Screening Values for Subsurface Soil (Continued)**

<b>Analysis</b>	<b>Provisional Background<sup>a</sup></b>	<b>Excavation Worker NAL<sup>b</sup></b>	<b>Excavation Worker AL<sup>c</sup></b>	<b>SSL (DAF 1)<sup>d</sup></b>	<b>SSL (DAF 58)<sup>d</sup></b>
<b>Organics—Volatiles (mg/kg)</b>					
1,1,1-Trichloroethane	N/A	4.54E+03	1.00E+05	7.01E-02	4.07E+00
1,1,2-Trichloro-1,2,2-trifluoroethane	N/A	2.23E+04	1.00E+05	1.38E+01	7.99E+02
1,1,2-Trichloroethane	N/A	8.49E-01	2.55E+01	1.62E-03	9.41E-02
1,1-Dichloroethane	N/A	9.52E+01	9.52E+03	7.81E-04	4.53E-02
1,1-Dichloroethene	N/A	1.26E+02	3.78E+03	2.51E-03	1.46E-01
1,2-Dichloroethane	N/A	1.13E+01	5.19E+02	1.42E-03	8.22E-02
1,2-Dimethylbenzene <sup>g</sup>	N/A	3.09E+02	9.27E+03	1.90E-02	1.10E+00
Acrylonitrile	N/A	4.46E+00	2.71E+02	1.14E-05	6.60E-04
Benzene	N/A	2.59E+01	1.28E+03	2.56E-03	1.48E-01
Bromodichloromethane	N/A	7.93E+00	7.93E+02	2.17E-02	1.26E+00
Carbon tetrachloride	N/A	1.57E+01	1.57E+03	1.94E-03	1.13E-01
Chloroform	N/A	8.90E+00	8.90E+02	2.22E-02	1.29E+00
<i>cis</i> -1,2-Dichloroethene	N/A	6.58E+01	1.97E+03	2.06E-02	1.19E+00
Dichlorodifluoromethane <sup>h</sup>	N/A	4.94E+01	1.48E+03	3.04E-02	1.76E+00
Ethylbenzene	N/A	1.30E+02	1.30E+04	7.85E-01	4.55E+01
<i>m,p</i> -Xylene <sup>i</sup>	N/A	3.27E+02	9.81E+03	9.85E+00	5.71E+02
Tetrachloroethene	N/A	4.34E+01	1.30E+03	2.27E-03	1.31E-01
Toluene	N/A	2.18E+03	6.54E+04	6.92E-01	4.01E+01
Total Xylene <sup>i</sup>	N/A	3.27E+02	9.81E+03	9.85E+00	5.71E+02
<i>trans</i> -1,2-Dichloroethene	N/A	7.85E+01	2.36E+03	2.94E-02	1.71E+00
Trichloroethene	N/A	2.26E+00	6.78E+01	1.79E-03	1.04E-01
Vinyl chloride	N/A	4.72E+00	4.72E+02	6.90E-04	4.00E-02
<b>Radionuclides (pCi/g)</b>					
Americium-241	N/A	1.66E+01	1.66E+03	9.58E-01	5.55E+01
Cesium-137	2.80E-01	6.84E-01	6.84E+01	4.79E-01	2.78E+01
Neptunium-237	N/A	1.50E+00	1.50E+02	5.36E-02	3.11E+00
Plutonium-238	N/A	2.12E+01	2.12E+03	2.19E-01	1.27E+01
Plutonium-239/240	N/A	1.85E+01	1.85E+03	2.13E-01	1.23E+01
Technetium-99	2.80E+00	1.54E+03	1.00E+05	7.60E-03	4.41E-01
Thorium-230	1.40E+00	2.85E+01	2.85E+03	1.83E+00	1.06E+02
Uranium-234	1.20E+00	4.35E+01	4.35E+03	4.95E-02	2.87E+00
Uranium-235	6.00E-02	2.20E+00	2.20E+02	4.88E-02	2.83E+00
Uranium-238	1.20E+00	8.72E+00	8.72E+02	4.03E-02	2.34E+00

<sup>a</sup> Subsurface background values are reported in the Risk Methods Document, Table A.12 (DOE 2015b).

<sup>b</sup> The excavation worker NALs are the lesser of the values for HI of 0.1 and ELCR of 1E-06 [Risk Methods Document, Table A.4 (DOE 2015b)].

<sup>c</sup> The excavation worker ALs are the lesser of the values for HI of 3 and ELCR of 1E-04 [Risk Methods Document, Table A.1 (DOE 2015b)].

<sup>d</sup> For nonradionuclides, SSLs are from the EPA MCL of Table A.7a, if available. If no EPA MCL was available, SSLs are from PGDP NALs for the Resident. For radionuclides, SSLs are from the 10<sup>-6</sup> values in the Risk Methods Document, Table A.7b (DOE 2015b).

<sup>e</sup> Chromium is assessed as chromium (total).

<sup>f</sup> 2-Nitrobenzenamine also is known as 2-nitroaniline.

<sup>g</sup> 1,2-Dimethylbenzene also is known as o-xylene.

<sup>h</sup> Dichlorodifluoromethane also is known as Freon-12.

<sup>i</sup> *m,p*-Xylene and total xylene are assessed as xylene, mixture.

Table 4.3. Screening Values for Groundwater

Analysis	RGA Background <sup>a</sup>	McNairy Background <sup>a</sup>	Child Resident NAL <sup>b</sup>	Child Resident AL <sup>c</sup>	MCL <sup>d</sup>
<b><i>Inorganics—Metals (mg/L)</i></b>					
Aluminum	2.19E+00	6.87E-01	1.99E+00	5.97E+01	N/A
Arsenic	5.00E-03	5.00E-03	5.16E-05	5.16E-03	1.00E-02
Barium	2.35E-01	2.96E-01	3.70E-01	1.11E+01	2.00E+00
Beryllium	4.00E-03	1.70E-02	2.19E-03	6.57E-02	4.00E-03
Cadmium	1.00E-02	1.00E-02	8.98E-04	2.69E-02	5.00E-03
Chromium <sup>e</sup>	1.44E-01	6.00E-02	2.08E-00	6.24E+01	1.00E-01
Cobalt	4.50E-02	9.60E-02	6.00E-04	1.80E-02	N/A
Copper	3.60E-02	5.70E-02	7.98E-02	2.39E+00	1.30E+00
Iron	5.03E+00	1.84E+01	1.40E+00	4.20E+01	N/A
Lead	1.29E-01	5.00E-02	1.50E-02	3.00E-02	1.50E-02
Manganese	1.19E-01	9.41E-01	4.20E-02	1.26E+00	N/A
Mercury	2.00E-04	2.00E-04	5.56E-04	1.67E-02	2.00E-03
Nickel	6.82E-01	1.09E-01	3.90E-02	1.17E+00	N/A
Selenium	5.00E-03	5.00E-03	9.97E-03	2.99E-01	5.00E-02
Vanadium	1.34E-01	1.26E-01	8.26E-03	2.48E-01	N/A
Zinc	5.40E-02	1.42E-01	6.00E-01	1.80E+01	N/A
<b><i>Organics—PCBs and Semivolatiles (mg/L)</i></b>					
PCB, Total	N/A	N/A	1.95E-04	1.95E-02	5.00E-04
Naphthalene	N/A	N/A	1.65E-04	1.65E-02	N/A
Bis(2-ethylhexyl)phthalate	N/A	N/A	5.56E-03	5.56E-01	N/A
<b><i>Organics—Volatiles (mg/L)</i></b>					
1,1,2-Trichloro-1,2,2-trifluoroethane	N/A	N/A	5.48E+00	1.64E+02	N/A
1,1-Dichloroethane	N/A	N/A	2.75E-03	2.75E-01	N/A
1,1-Dichloroethene	N/A	N/A	1.71E-04	1.71E-02	7.00E-03
1,2-Dichloroethane	N/A	N/A	2.83E-02	8.49E-01	5.00E-03
1,2-Dimethylbenzene <sup>f</sup>	N/A	N/A	1.92E-02	5.76E-01	N/A
Benzene	N/A	N/A	4.53E-04	4.53E-02	5.00E-03
Bromomethane	N/A	N/A	N/A	N/A	N/A
Carbon tetrachloride	N/A	N/A	4.52E-04	4.52E-02	5.00E-03
Chloroform	N/A	N/A	2.21E-04	2.21E-02	8.00E-02
cis-1,2-Dichloroethene	N/A	N/A	3.56E-03	1.07E-01	7.00E-02
Ethylbenzene	N/A	N/A	1.49E-03	1.49E-01	7.00E-01
Tetrachloroethene	N/A	N/A	3.95E-03	1.19E-01	5.00E-03
Toluene	N/A	N/A	1.07E-01	3.21E+00	N/A
Total Xylene <sup>g</sup>	N/A	N/A	1.92E-02	5.76E-01	1.00E+01
trans-1,2-Dichloroethene	N/A	N/A	9.26E-03	2.78E-01	1.00E-01
Trichloroethene	N/A	N/A	2.81E-04	8.43E-03	5.00E-03
Vinyl chloride	N/A	N/A	1.87E-05	1.87E-03	2.00E-03

**Table 4.3. Screening Values for Groundwater (Continued)**

<b>Analysis</b>	<b>RGA Background<sup>a</sup></b>	<b>McNairy Background<sup>a</sup></b>	<b>Child Resident NAL<sup>b</sup></b>	<b>Child Resident AL<sup>c</sup></b>	<b>MCL<sup>d</sup></b>
<b><i>Radionuclides (pCi/L)</i></b>					
Alpha activity	5.80E+00	1.19E+01	N/A	N/A	1.50E+01
Beta activity	1.38E+01	1.45E+02	N/A	N/A	N/A
Technetium-99	2.23E+01	2.06E+01	1.90E+01	1.90E+03	<sup>h</sup>
Uranium-234	7.00E-01	3.00E-01	7.39E-01	7.39E+01	1.02E+01
Uranium-235	3.00E-01	2.00E-01	7.28E-01	7.28E+01	4.66E-01
Uranium-238	7.00E-01	3.00E-01	6.01E-01	6.01E+01	9.99E+00

<sup>a</sup> RGA and McNairy background values are reported in the Risk Methods Document, Table A.13, and are taken from the "Over All Observations" values (DOE 2015b).

<sup>b</sup> The child resident NALs are the lesser of the values for HI of 0.1 for the child resident and ELCR of 1E-06 for the adult/child combined lifetime [Risk Methods Document, Table A.5 (DOE 2015b)].

<sup>c</sup> The child resident ALs are the lesser of the values for HI of 3 for the child resident and ELCR of 1E-04 for the adult/child combined lifetime [Risk Methods Document, Table A.2 (DOE 2015b)].

<sup>d</sup> Except for alpha activity, MCLs are taken from the primary MCLs listed in Table A.14 of the Risk Methods Document (DOE 2015b). MCL for alpha activity is taken from <http://www.epa.gov/your-drinking-water/table-regulated-drinking-water-contaminants>, last updated February 18, 2016; accessed March 11, 2016.

<sup>e</sup> Chromium is assessed as chromium (total).

<sup>f</sup> 1,2-Dimethylbenzene also is known as o-xylene.

<sup>g</sup> Total xylene is assessed as xylene, mixture.

<sup>h</sup> The MCL for Tc-99 is 4 mrem/yr. The value derived by EPA from the 4 mrem/yr MCL for Tc-99 is 900 pCi/L. An alternate value derived by EPA from the 4 mrem/yr MCL is 3,790 pCi/L and was proposed in the July 18, 1991, *Federal Register*. Results in this BGOU RI Report Addendum are screened using 900 pCi/L, which is consistent with BGOU RI Report (DOE 2010a).



Table 4.4. SWMU 4 Surface Soil (0-1 ft bgs) Data Summary

Type	Analysis	Unit	Detected Results			FOD	Background		Industrial Worker		Excavation Worker		GW Protection Screen		DL Range
			Min	Max	Avg		FOE	NAL FOE	AL FOE	NAL FOE	AL FOE	RGA	UCRS		
METAL	Aluminum	mg/kg	3.32E+03	1.29E+04	8.86E+03	16/16	0/16	0/16	0/16	0/16	0/16	0/16	16/16	18.2 - 20	
METAL	Antimony	mg/kg	N/A	N/A	N/A	0/16	0/16	0/16	0/16	0/16	0/16	0/16	0/16	9.08 - 20	
METAL	Arsenic	mg/kg	1.30E+00	2.94E+01	7.13E+00	145/191	6/191	144/191	0/191	142/191	0/191	4/191	145/191	0.92 - 5	
METAL	Barium	mg/kg	1.21E+01	4.89E+02	2.83E+02	178/191	146/191	0/191	0/191	0/191	0/191	169/191	0/191	0.515 - 10	
METAL	Beryllium	mg/kg	5.10E-01	2.45E+00	8.08E-01	19/46	9/46	0/46	0/46	0/46	0/46	0/46	0/46	0.45 - 0.632	
METAL	Cadmium	mg/kg	6.17E-01	1.32E+00	9.23E-01	10/191	10/191	0/191	0/191	0/191	0/191	10/191	10/191	0.515 - 6	
METAL	Calcium	mg/kg	8.39E+01	1.22E+05	1.12E+04	16/16	0/16	N/A	N/A	N/A	N/A	N/A	N/A	50 - 926	
METAL	Chromium	mg/kg	4.33E+00	2.96E+02	4.98E+01	166/191	141/191	1/191	0/191	0/191	0/191	0/191	0/191	1.03 - 5	
METAL	Cobalt	mg/kg	3.06E+00	7.54E+00	5.20E+00	16/16	0/16	0/16	0/16	0/16	0/16	16/16	16/16	1 - 2.44	
METAL	Copper	mg/kg	6.57E+00	5.81E+01	1.58E+01	16/16	3/16	0/16	0/16	0/16	0/16	0/16	1/16	2 - 2.44	
METAL	Cyanide	mg/kg	N/A	N/A	N/A	0/12	0/12	0/12	0/12	0/12	0/12	0/12	0/12	1 - 1	
METAL	Iron	mg/kg	4.57E+03	1.25E+05	1.41E+04	191/191	4/191	1/191	1/191	5/191	1/191	191/191	191/191	5 - 112	
METAL	Lead	mg/kg	5.25E+00	1.06E+02	2.04E+01	178/191	12/191	0/191	0/191	0/191	0/191	0/191	158/191	1.03 - 20	
METAL	Magnesium	mg/kg	2.70E+02	3.51E+03	1.34E+03	16/16	0/16	N/A	N/A	N/A	N/A	N/A	N/A	4.54 - 15	
METAL	Manganese	mg/kg	4.93E+01	4.47E+04	6.25E+02	191/191	3/191	1/191	0/191	9/191	1/191	180/191	191/191	1 - 115	
METAL	Mercury	mg/kg	2.40E-02	1.00E+01	1.11E+00	32/188	7/188	0/188	0/188	1/188	0/188	5/188	26/188	0.017 - 2	
METAL	Molybdenum	mg/kg	7.05E+00	7.05E+00	7.05E+00	1/4	N/A	0/4	0/4	0/4	0/4	0/4	1/4	4.54 - 4.88	
METAL	Nickel	mg/kg	5.03E+00	1.82E+02	2.98E+01	87/191	43/191	0/191	1.82E+01	0/191	0/191	2/191	87/191	1.03 - 10.7	
METAL	Potassium	mg/kg	1.89E+02	9.43E+02	5.48E+02	16/16	0/16	N/A	N/A	N/A	N/A	N/A	N/A	90.8 - 100	
METAL	Selenium	mg/kg	N/A	N/A	N/A	0/191	0/191	0/191	0/191	0/191	0/191	0/191	0/191	1 - 19.5	
METAL	Silver	mg/kg	1.70E+01	3.70E+01	2.32E+01	26/191	26/191	0/191	0/191	0/191	0/191	26/191	26/191	1.03 - 6	
METAL	Sodium	mg/kg	1.12E+02	3.20E+02	2.27E+02	5/16	0/16	N/A	N/A	N/A	N/A	N/A	N/A	90.8 - 200	
METAL	Thallium	mg/kg	N/A	N/A	N/A	0/16	0/16	0/16	0/16	0/16	0/16	0/16	0/16	15 - 19.5	
METAL	Uranium	mg/kg	1.39E+00	2.84E+03	3.92E+02	97/179	92/179	17/179	0/179	65/179	0/179	14/179	90/179	0.13 - 115	
METAL	Vanadium	mg/kg	4.47E+00	6.57E+01	2.18E+01	46/46	4/46	0/46	0/46	0/46	0/46	44/46	44/46	2 - 2.53	
METAL	Zinc	mg/kg	2.74E+01	1.32E+02	5.28E+01	15/16	3/16	0/16	0/16	0/16	0/16	9/16	9/16	15 - 19.5	
PCB	PCB, Total	mg/kg	4.10E-02	2.22E+02	6.89E+00	95/237	N/A	85/237	2/237	77/237	1/237	66/237	93/237	0.1 - 12.4	
SVOA	1,2,4-Trichlorobenzene	mg/kg	N/A	N/A	N/A	0/10	N/A	N/A	N/A	N/A	N/A	N/A	N/A	0.46 - 0.5	
SVOA	1,2-Dichlorobenzene	mg/kg	N/A	N/A	N/A	0/10	N/A	N/A	N/A	N/A	N/A	N/A	N/A	0.46 - 0.5	
SVOA	1,3-Dichlorobenzene	mg/kg	N/A	N/A	N/A	0/10	N/A	N/A	N/A	N/A	N/A	N/A	N/A	0.46 - 0.5	
SVOA	1,4-Dichlorobenzene	mg/kg	N/A	N/A	N/A	0/10	N/A	N/A	N/A	N/A	N/A	N/A	N/A	0.46 - 0.5	
SVOA	2,4,5-Trichlorophenol	mg/kg	N/A	N/A	N/A	0/10	N/A	N/A	N/A	N/A	N/A	N/A	N/A	0.46 - 0.5	
SVOA	2,4,6-Trichlorophenol	mg/kg	N/A	N/A	N/A	0/10	N/A	N/A	N/A	N/A	N/A	N/A	N/A	0.46 - 0.5	
SVOA	2,4-Dichlorophenol	mg/kg	N/A	N/A	N/A	0/10	N/A	N/A	N/A	N/A	N/A	N/A	N/A	0.46 - 0.5	
SVOA	2,4-Dimethylphenol	mg/kg	N/A	N/A	N/A	0/10	N/A	N/A	N/A	N/A	N/A	N/A	N/A	0.46 - 0.5	
SVOA	2,4-Dinitrophenol	mg/kg	N/A	N/A	N/A	0/5	N/A	N/A	N/A	N/A	N/A	N/A	N/A	0.46 - 0.5	
SVOA	2,4-Dinitrotoluene	mg/kg	N/A	N/A	N/A	0/10	N/A	N/A	N/A	N/A	N/A	N/A	N/A	0.46 - 0.5	
SVOA	2,6-Dinitrotoluene	mg/kg	N/A	N/A	N/A	0/10	N/A	N/A	N/A	N/A	N/A	N/A	N/A	0.46 - 0.5	
SVOA	2-Chloronaphthalene	mg/kg	N/A	N/A	N/A	0/10	N/A	N/A	N/A	N/A	N/A	N/A	N/A	0.46 - 0.5	
SVOA	2-Chlorophenol	mg/kg	N/A	N/A	N/A	0/10	N/A	N/A	N/A	N/A	N/A	N/A	N/A	0.46 - 0.5	
SVOA	2-Methyl-4,6-dinitrophenol	mg/kg	N/A	N/A	N/A	0/10	N/A	N/A	N/A	N/A	N/A	N/A	N/A	0.46 - 0.5	
SVOA	2-Methylnaphthalene	mg/kg	N/A	N/A	N/A	0/10	N/A	N/A	N/A	N/A	N/A	N/A	N/A	0.46 - 0.5	
SVOA	2-Methylphenol	mg/kg	N/A	N/A	N/A	0/10	N/A	N/A	N/A	N/A	N/A	N/A	N/A	0.46 - 0.5	
SVOA	2-Nitrobenzamine	mg/kg	N/A	N/A	N/A	0/40	N/A	0/40	0/40	0/40	0/40	0/40	0/40	0.46 - 0.66	
SVOA	2-Nitrophenol	mg/kg	N/A	N/A	N/A	0/10	N/A	N/A	N/A	N/A	N/A	N/A	N/A	0.46 - 0.5	
SVOA	3,3'-Dichlorobenzidine	mg/kg	N/A	N/A	N/A	0/10	N/A	N/A	N/A	N/A	N/A	N/A	N/A	0.46 - 0.5	
SVOA	3-Nitrobenzamine	mg/kg	N/A	N/A	N/A	0/10	N/A	N/A	N/A	N/A	N/A	N/A	N/A	0.46 - 0.5	

Table 4.4. SWMU 4 Surface Soil (0-1 ft bgs) Data Summary (Continued)

Type	Analysis	Unit	Detected Results			FOD	Background	Industrial Worker			Excavation Worker		GW Protection Screen		DL Range
			Min	Max	Avg		FOE	NAL FOE	AL FOE	NAL FOE	AL FOE	RGA	UCRS		
SVOA	4-Bromophenyl phenyl ether	mg/kg	N/A	N/A	N/A	0/10	N/A	N/A	N/A	N/A	N/A	N/A	N/A	0.46 - 0.5	
SVOA	4-Chloro-3-methylphenol	mg/kg	N/A	N/A	N/A	0/10	N/A	N/A	N/A	N/A	N/A	N/A	N/A	0.46 - 0.5	
SVOA	4-Chlorobenzenamine	mg/kg	N/A	N/A	N/A	0/10	N/A	N/A	N/A	N/A	N/A	N/A	N/A	0.46 - 0.5	
SVOA	4-Chlorophenyl phenyl ether	mg/kg	N/A	N/A	N/A	0/10	N/A	N/A	N/A	N/A	N/A	N/A	N/A	0.46 - 0.5	
SVOA	4-Methylphenol	mg/kg	N/A	N/A	N/A	0/10	N/A	N/A	N/A	N/A	N/A	N/A	N/A	0.46 - 0.5	
SVOA	4-Nitrophenol	mg/kg	N/A	N/A	N/A	0/10	N/A	N/A	N/A	N/A	N/A	N/A	N/A	0.46 - 0.5	
SVOA	Acenaphthene	mg/kg	N/A	N/A	N/A	0/44	N/A	0/44	0/44	0/44	0/44	0/44	0/44	0.46 - 0.66	
SVOA	Acenaphthylene	mg/kg	N/A	N/A	N/A	0/44	N/A	N/A	0/44	0/44	0/44	N/A	N/A	0.46 - 0.66	
SVOA	Anthracene	mg/kg	N/A	N/A	N/A	0/44	N/A	0/44	0/44	0/44	0/44	0/44	0/44	0.46 - 0.66	
SVOA	Benzo(ghi)perylene	mg/kg	N/A	N/A	N/A	0/14	N/A	N/A	N/A	N/A	N/A	N/A	N/A	0.46 - 0.5	
SVOA	Bis(2-chloroethoxy)methane	mg/kg	N/A	N/A	N/A	0/10	N/A	N/A	N/A	N/A	N/A	N/A	N/A	0.46 - 0.5	
SVOA	Bis(2-chloroethyl) ether	mg/kg	N/A	N/A	N/A	0/10	N/A	N/A	N/A	N/A	N/A	N/A	N/A	0.46 - 0.5	
SVOA	Bis(2-chloroisopropyl) ether	mg/kg	N/A	N/A	N/A	0/10	N/A	N/A	N/A	N/A	N/A	N/A	N/A	0.46 - 0.5	
SVOA	Bis(2-ethylhexyl)phthalate	mg/kg	N/A	N/A	N/A	0/10	N/A	0/10	0/10	0/10	0/10	0/10	0/10	0.46 - 0.5	
SVOA	Butyl benzyl phthalate	mg/kg	N/A	N/A	N/A	0/5	N/A	N/A	N/A	N/A	N/A	N/A	N/A	0.46 - 0.5	
SVOA	Carbazole	mg/kg	N/A	N/A	N/A	0/40	N/A	0/40	0/40	0/40	0/40	0/40	0/40	0.46 - 0.66	
SVOA	Dibenzofuran	mg/kg	N/A	N/A	N/A	0/10	N/A	N/A	N/A	N/A	N/A	N/A	N/A	0.46 - 0.5	
SVOA	Diethyl phthalate	mg/kg	N/A	N/A	N/A	0/10	N/A	N/A	N/A	N/A	N/A	N/A	N/A	0.46 - 0.5	
SVOA	Dimethyl phthalate	mg/kg	N/A	N/A	N/A	0/10	N/A	N/A	N/A	N/A	N/A	N/A	N/A	0.46 - 0.5	
SVOA	Di-n-butyl phthalate	mg/kg	N/A	N/A	N/A	0/10	N/A	N/A	N/A	N/A	N/A	N/A	N/A	0.46 - 0.5	
SVOA	Di-n-octylphthalate	mg/kg	N/A	N/A	N/A	0/10	N/A	N/A	N/A	N/A	N/A	N/A	N/A	0.46 - 0.5	
SVOA	Fluoranthene	mg/kg	8.40E-01	2.90E+00	1.81E+00	3/44	N/A	0/44	0/44	0/44	0/44	0/44	0/44	0.46 - 0.66	
SVOA	Fluorene	mg/kg	N/A	N/A	N/A	0/14	N/A	0/14	0/14	0/14	0/14	0/14	0/14	0.46 - 0.5	
SVOA	Hexachlorobenzene	mg/kg	N/A	N/A	N/A	0/40	N/A	0/40	0/40	0/40	0/40	0/40	0/40	0.46 - 0.66	
SVOA	Hexachlorobutadiene	mg/kg	N/A	N/A	N/A	0/10	N/A	N/A	N/A	N/A	N/A	N/A	N/A	0.46 - 0.5	
SVOA	Hexachlorocyclopentadiene	mg/kg	N/A	N/A	N/A	0/10	N/A	N/A	N/A	N/A	N/A	N/A	N/A	0.46 - 0.5	
SVOA	Hexachloroethane	mg/kg	N/A	N/A	N/A	0/10	N/A	N/A	N/A	N/A	N/A	N/A	N/A	0.46 - 0.5	
SVOA	Isophorone	mg/kg	N/A	N/A	N/A	0/10	N/A	N/A	N/A	N/A	N/A	N/A	N/A	0.46 - 0.5	
SVOA	Naphthalene	mg/kg	N/A	N/A	N/A	0/44	N/A	0/44	0/44	0/44	0/44	0/44	0/44	0.46 - 0.66	
SVOA	Nitrobenzene	mg/kg	N/A	N/A	N/A	0/10	N/A	N/A	N/A	N/A	N/A	N/A	N/A	0.46 - 0.5	
SVOA	N-Nitroso-di-n-propylamine	mg/kg	N/A	N/A	N/A	0/40	N/A	0/40	0/40	0/40	0/40	0/40	0/40	0.46 - 0.66	
SVOA	N-Nitrosodiphenylamine	mg/kg	N/A	N/A	N/A	0/10	N/A	N/A	N/A	N/A	N/A	N/A	N/A	0.46 - 0.5	
SVOA	Pentachlorophenol	mg/kg	N/A	N/A	N/A	0/10	N/A	0/10	0/10	0/10	0/10	0/10	0/10	0.46 - 0.5	
SVOA	Phenanthrene	mg/kg	1.00E+00	1.40E+00	1.20E+00	2/44	N/A	0/44	0/44	0/44	0/44	0/44	2/44	0.46 - 0.66	
SVOA	Phenol	mg/kg	N/A	N/A	N/A	0/10	N/A	N/A	N/A	N/A	N/A	N/A	N/A	0.46 - 0.5	
SVOA	p-Nitroaniline	mg/kg	N/A	N/A	N/A	0/10	N/A	N/A	N/A	N/A	N/A	N/A	N/A	0.46 - 0.5	
SVOA	Pyrene	mg/kg	7.10E-01	2.00E+00	1.40E+00	3/44	N/A	0/44	0/44	0/44	0/44	0/44	2/44	0.46 - 0.66	
SVOA	Pyridine	mg/kg	N/A	N/A	N/A	0/2	N/A	N/A	N/A	N/A	N/A	N/A	N/A	0.46 - 0.47	
SVOA	Total PAH	mg/kg	7.30E-02	1.71E+00	9.08E-01	3/44	N/A	2/44	0/44	2/44	0/44	0/44	2/44	-	
VOA	1,1,1-Trichloroethane	mg/kg	N/A	N/A	N/A	0/13	N/A	0/13	0/13	0/13	0/13	0/13	0/13	0.005 - 0.01	
VOA	1,1,2,2-Tetrachloroethane	mg/kg	N/A	N/A	N/A	0/9	N/A	N/A	N/A	N/A	N/A	N/A	N/A	0.01 - 0.01	
VOA	1,1,2-Trichloro-1,2,2-trifluoroethane	mg/kg	N/A	N/A	N/A	0/13	N/A	0/13	0/13	0/13	0/13	0/13	0/13	0.0048 - 0.00597	
VOA	1,1,2-Trichloroethane	mg/kg	N/A	N/A	N/A	0/9	N/A	0/9	0/9	0/9	0/9	0/9	0/9	0.01 - 0.01	
VOA	1,1-Dichloroethane	mg/kg	N/A	N/A	N/A	0/9	N/A	0/9	0/9	0/9	0/9	0/9	0/9	0.01 - 0.01	
VOA	1,1-Dichloroethene	mg/kg	N/A	N/A	N/A	0/23	N/A	0/23	0/23	0/23	0/23	0/23	0/23	0.0048 - 0.502	
VOA	1,2-Dichloroethane	mg/kg	N/A	N/A	N/A	0/9	N/A	0/9	0/9	0/9	0/9	0/9	0/9	0.01 - 0.01	

Table 4.4. SWMU 4 Surface Soil (0-1 ft bgs) Data Summary (Continued)

Type	Analysis	Unit	Detected Results			FOD	Background	Industrial Worker			Excavation Worker		GW Protection Screen		DL Range
			Min	Max	Avg		FOE	NAL FOE	AL FOE	NAL FOE	AL FOE	RGA	UCRS		
VOA	1,2-Dichloropropane	mg/kg	N/A	N/A	N/A	0/9	N/A	N/A	N/A	N/A	N/A	N/A	N/A	0.01 - 0.01	
VOA	1,2-Dimethylbenzene	mg/kg	N/A	N/A	N/A	0/22	N/A	0/22	0/22	0/22	0/22	0/22	0/22	0.0048 - 0.01	
VOA	2-Butanone	mg/kg	N/A	N/A	N/A	0/9	N/A	N/A	N/A	N/A	N/A	N/A	N/A	0.01 - 0.01	
VOA	2-Hexanone	mg/kg	N/A	N/A	N/A	0/9	N/A	N/A	N/A	N/A	N/A	N/A	N/A	0.01 - 0.01	
VOA	4-Methyl-2-pentanone	mg/kg	N/A	N/A	N/A	0/9	N/A	N/A	N/A	N/A	N/A	N/A	N/A	0.01 - 0.01	
VOA	Acetone	mg/kg	N/A	N/A	N/A	0/3	N/A	N/A	N/A	N/A	N/A	N/A	N/A	0.01 - 0.01	
VOA	Acrylonitrile	mg/kg	N/A	N/A	N/A	0/13	N/A	0/13	0/13	0/13	0/13	0/13	0/13	0.0048 - 0.00597	
VOA	Benzene	mg/kg	N/A	N/A	N/A	0/22	N/A	0/22	0/22	0/22	0/22	0/22	0/22	0.0048 - 0.01	
VOA	Bromodichloromethane	mg/kg	N/A	N/A	N/A	0/9	N/A	0/9	0/9	0/9	0/9	0/9	0/9	0.01 - 0.01	
VOA	Bromoform	mg/kg	N/A	N/A	N/A	0/9	N/A	N/A	N/A	N/A	N/A	N/A	N/A	0.01 - 0.01	
VOA	Bromomethane	mg/kg	N/A	N/A	N/A	0/9	N/A	N/A	N/A	N/A	N/A	N/A	N/A	0.01 - 0.01	
VOA	Carbon disulfide	mg/kg	N/A	N/A	N/A	0/9	N/A	N/A	N/A	N/A	N/A	N/A	N/A	0.01 - 0.01	
VOA	Carbon tetrachloride	mg/kg	N/A	N/A	N/A	0/22	N/A	0/22	0/22	0/22	0/22	0/22	0/22	0.0048 - 0.01	
VOA	Chlorobenzene	mg/kg	N/A	N/A	N/A	0/9	N/A	N/A	N/A	N/A	N/A	N/A	N/A	0.01 - 0.01	
VOA	Chloroethane	mg/kg	N/A	N/A	N/A	0/9	N/A	N/A	N/A	N/A	N/A	N/A	N/A	0.01 - 0.01	
VOA	Chloroform	mg/kg	N/A	N/A	N/A	0/22	N/A	0/22	0/22	0/22	0/22	0/22	0/22	0.0048 - 0.01	
VOA	Chloromethane	mg/kg	N/A	N/A	N/A	0/9	N/A	N/A	N/A	N/A	N/A	N/A	N/A	0.01 - 0.01	
VOA	cis -1,2-Dichloroethene	mg/kg	N/A	N/A	N/A	0/23	N/A	0/23	0/23	0/23	0/23	0/23	0/23	0.0048 - 0.502	
VOA	cis -1,3-Dichloropropene	mg/kg	N/A	N/A	N/A	0/9	N/A	N/A	N/A	N/A	N/A	N/A	N/A	0.01 - 0.01	
VOA	Dibromochloromethane	mg/kg	N/A	N/A	N/A	0/9	N/A	N/A	N/A	N/A	N/A	N/A	N/A	0.01 - 0.01	
VOA	Dichlorodifluoromethane	mg/kg	N/A	N/A	N/A	0/13	N/A	0/13	0/13	0/13	0/13	0/13	0/13	0.0048 - 0.00597	
VOA	Ethylbenzene	mg/kg	N/A	N/A	N/A	0/22	N/A	0/22	0/22	0/22	0/22	0/22	0/22	0.0048 - 0.01	
VOA	m,p-Xylene	mg/kg	N/A	N/A	N/A	0/22	N/A	0/22	0/22	0/22	0/22	0/22	0/22	0.0096 - 0.02	
VOA	Methylene chloride	mg/kg	1.50E-02	1.50E-02	1.50E-02	1/9	N/A	N/A	N/A	N/A	N/A	N/A	N/A	0.01 - 0.01	
VOA	Styrene	mg/kg	N/A	N/A	N/A	0/9	N/A	N/A	N/A	N/A	N/A	N/A	N/A	0.01 - 0.01	
VOA	Tetrachloroethene	mg/kg	N/A	N/A	N/A	0/22	N/A	0/22	0/22	0/22	0/22	0/22	0/22	0.0048 - 0.01	
VOA	Toluene	mg/kg	N/A	N/A	N/A	0/22	N/A	0/22	0/22	0/22	0/22	0/22	0/22	0.0048 - 0.01	
VOA	Total Xylene	mg/kg	N/A	N/A	N/A	0/13	N/A	0/13	0/13	0/13	0/13	0/13	0/13	0.0144 - 0.0179	
VOA	trans -1,2-Dichloroethene	mg/kg	N/A	N/A	N/A	0/10	N/A	0/10	0/10	0/10	0/10	0/10	0/10	0.01 - 0.502	
VOA	trans -1,3-Dichloropropene	mg/kg	N/A	N/A	N/A	0/9	N/A	N/A	N/A	N/A	N/A	N/A	N/A	0.01 - 0.01	
VOA	Trichloroethene	mg/kg	N/A	N/A	N/A	0/27	N/A	0/27	0/27	0/27	0/27	0/27	0/27	0.0048 - 0.502	
VOA	Vinyl chloride	mg/kg	N/A	N/A	N/A	0/23	N/A	0/23	0/23	0/23	0/23	0/23	0/23	0.0048 - 0.502	
RADS	Alpha activity	pCi/g	1.23E+01	8.50E+01	3.50E+01	16/16	N/A	N/A	N/A	N/A	N/A	N/A	N/A	0.96 - 11	
RADS	Americium-241	pCi/g	3.72E-02	6.49E-01	3.43E-01	2/52	N/A	0/52	0/52	0/52	0/52	0/52	0/52	0.02 - 9.7	
RADS	Beta activity	pCi/g	1.94E+01	1.90E+02	5.05E+01	16/16	N/A	N/A	N/A	N/A	N/A	N/A	N/A	0.89 - 8.8	
RADS	Cesium-137	pCi/g	4.80E-02	9.92E-01	2.75E-01	28/52	5/52	18/52	0/52	3/52	0/52	5/52	5/52	0.0254 - 3.5	
RADS	Cobalt-60	pCi/g	N/A	N/A	N/A	0/52	N/A	N/A	N/A	N/A	N/A	N/A	N/A	0.0225 - 3.7	
RADS	Neptunium-237	pCi/g	4.65E-02	4.72E+00	5.34E-01	26/45	20/45	11/45	0/45	2/45	0/45	1/45	25/45	0.03 - 0.112	
RADS	Plutonium-238	pCi/g	5.01E-02	5.01E-02	5.01E-02	1/34	0/34	0/34	0/34	0/34	0/34	0/34	0/34	0.0141 - 0.0548	
RADS	Plutonium-239/240	pCi/g	3.35E-02	4.05E+00	4.40E-01	18/45	18/45	0/45	0/45	0/45	0/45	0/45	8/45	0.02 - 0.0508	
RADS	Protactinium-234m	pCi/g	N/A	N/A	N/A	0/12	N/A	N/A	N/A	N/A	N/A	N/A	N/A	23 - 500	
RADS	Radium-226	pCi/g	N/A	N/A	N/A	0/5	0/5	N/A	N/A	N/A	N/A	N/A	N/A	0.511 - 0.648	
RADS	Technetium-99	pCi/g	1.31E+00	1.26E+02	1.79E+01	18/51	14/51	0/51	0/51	0/51	0/51	18/51	18/51	0.736 - 6.94	
RADS	Thorium-228	pCi/g	1.82E-01	7.15E-01	4.97E-01	4/4	0/4	N/A	N/A	N/A	N/A	N/A	N/A	0.16 - 0.17	
RADS	Thorium-230	pCi/g	6.20E-01	5.35E+01	3.76E+00	38/40	18/40	1/40	0/40	1/40	0/40	0/40	15/40	0.159 - 0.276	

**Table 4.4. SWMU 4 Surface Soil (0-1 ft bgs) Data Summary (Continued)**

Type	Analysis	Unit	Detected Results			FOD	Background	Industrial Worker		Excavation Worker		GW Protection Screen		DL Range
			Min	Max	Avg		FOE	NAL FOE	AL FOE	NAL FOE	AL FOE	RGA	UCRS	
RADS	Thorium-232	pCi/g	1.48E-01	6.97E-01	4.78E-01	4/4	0/4	N/A	N/A	N/A	N/A	N/A	N/A	0.04 - 0.05
RADS	Thorium-234	pCi/g	7.20E+00	8.80E+01	3.57E+01	6/12	N/A	N/A	N/A	N/A	N/A	N/A	N/A	0.767 - 22
RADS	Uranium-234	pCi/g	6.97E-01	7.44E+01	1.04E+01	39/39	32/39	2/39	0/39	2/39	0/39	23/39	39/39	0.08 - 2.3
RADS	Uranium-235	pCi/g	3.40E-02	4.40E+00	6.54E-01	33/46	27/46	15/46	0/46	3/46	0/46	2/46	28/46	0.02 - 7.9
RADS	Uranium-238	pCi/g	8.63E-01	2.31E+02	2.18E+01	39/39	32/39	32/39	1/39	21/39	0/39	32/39	39/39	0.04 - 2.18

- One or more samples exceed AL value
- One or more samples exceed NAL value
- One or more samples exceed background value
- One or more samples exceed SSLs of RGA and UCRS groundwater protection

Counts of analyses are based on the maximum detected result from a sample (i.e., if a sample has analytical results from two different labs, only the maximum value is counted). Field replicates, or separate samples are counted independently.

The uranium (metal)/uranium (isotopic) may not be from the same sample thus a correlation between uranium (metal)/uranium (isotopic) data may not be possible. Uranium-238 that was analyzed using method RL-7128NITRIC is compared to a background value of 0.4 pCi/g for surface and subsurface (DOE 2009).

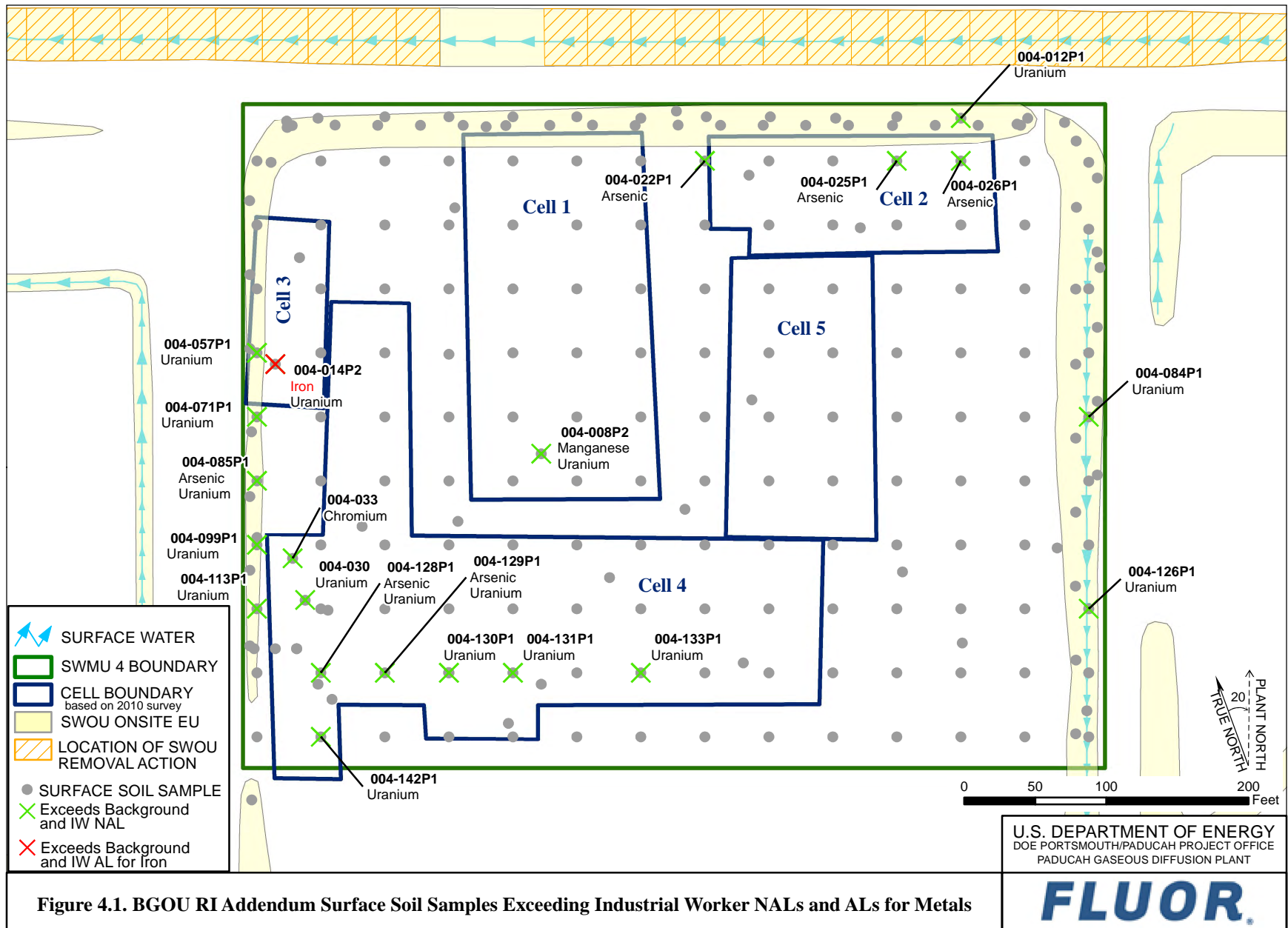

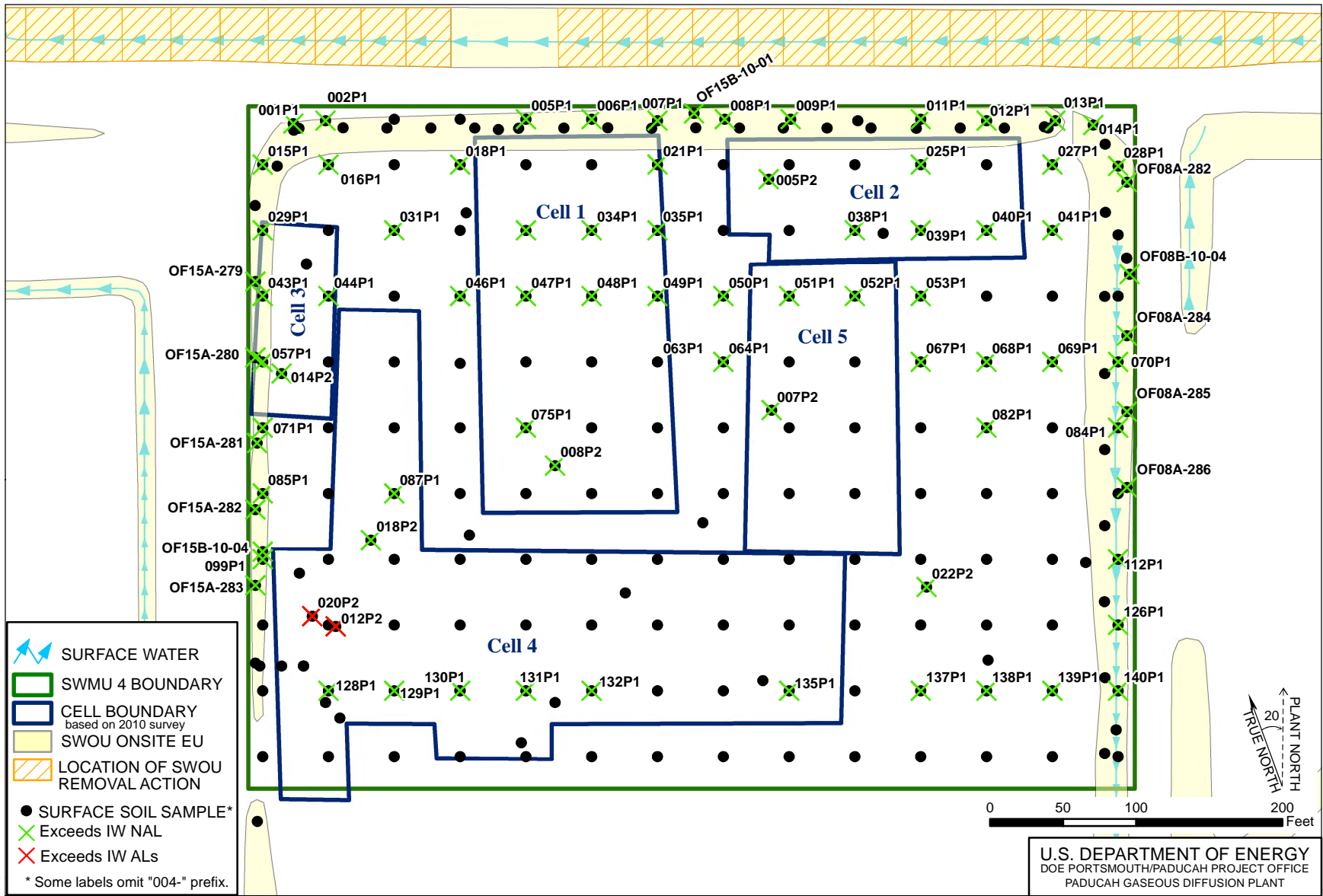

Figure 4.2. BGOU RI Addendum Surface Soil Samples Exceeding Industrial Worker NALs and ALs for PCBs

U.S. DEPARTMENT OF ENERGY  
DOE PORTSMOUTH/PADUCAH PROJECT OFFICE  
PADUCAH GASEOUS DIFFUSION PLANT





industrial worker and excavation worker AL in one sample, and manganese exceeded the excavation worker AL in one sample. Arsenic, iron, and manganese exceeded background in fewer than five percent of the analyses. Chromium exceeded background in 74% of the analyses, but exceeded the industrial worker NAL in only one sample. The metal that most commonly exceeded background (and also exceeded the NALs) was uranium. As shown in Figure 4.1, most of the uranium exceedances (13 of the 17 industrial worker NAL exceedances) were in the southwestern portion of the SWMU (most closely related to Burial Cells 3 and 4). The range of detected results for uranium was 1.39 to 2,840 mg/kg.

The following metals were detected in SWMU 4 surface soil above both the SSLs for the protection of UCRS groundwater and the background screening levels: arsenic, barium, cadmium, copper, iron, lead, manganese, mercury, nickel, silver, uranium, vanadium, and zinc. The following were detected above the SSLs for protection of RGA groundwater and the background screening levels: arsenic, iron, manganese, mercury, nickel, silver, and uranium.

### **PCBs**

Total PCBs were detected above the industrial worker NALs in 36% of the analyses and above the industrial worker AL in two of the analyses. Total PCBs also exceeded the excavation worker NALs in 32% of the analyses, with one result exceeding the excavation worker AL. The maximum detected value was 222 mg/kg of total PCBs. Figure 4.2 shows the locations of samples with PCBs exceeding the industrial worker NAL and AL at SWMU 4. The two sample locations that exceeded the industrial worker AL were grouped closely in the southwestern portion of SWMU 4 above Burial Cell 4.

Total PCBs were detected in SWMU 4 surface soil above the SSL for the protection of UCRS groundwater in 39% of the analyses and above the SSL for protection of RGA groundwater in 28% of the analyses.

### **SVOCs**

Of the SVOCs that were detected in surface soil (fluoranthene, phenanthrene, pyrene, and Total PAH), phenanthrene, pyrene, and Total PAH exceeded the SSL for protection of UCRS groundwater and none exceeded the SSL for protection of RGA groundwater. Only Total PAH exceeded the industrial worker and excavation worker NALs.

### **VOCs**

No VOCs were detected above the industrial worker NALs or ALs in the SWMU 4 surface soil. Methylene chloride, a common laboratory contaminant, was detected in one sample at 0.015 mg/kg.

### **Radionuclides**

The following radionuclides were detected in SWMU 4 surface soil above the background screening levels, the industrial worker NALs, and the excavation worker NALs: cesium-137, neptunium-237, thorium-230, uranium-234, uranium-235, and uranium-238. All of these radionuclides, with the exception of cesium-137, exceeded background in more than 40% of the analyses. Cesium-137 exceeded background in 10% of the analyses. Uranium-238 was the most common radionuclide to exceed background and the NAL values. Uranium-238 also exceeded the industrial worker AL in one sample. The range of detected activities of uranium-238 was up to 231 pCi/g. Figure 4.3 shows the locations where the various radionuclides exceeded both background and industrial worker screening levels. Uranium-238 is broadly distributed across the SWMU, with the maximum detection occurring above Burial Cell 4.



The following were detected above both the background screening levels and SSLs for the protection of UCRS groundwater: cesium-137, neptunium-237, plutonium-239/240, Tc-99, thorium-230, uranium-234, uranium-235, and uranium-238. These same radionuclides, with the exception of cesium-137, plutonium-239/240, and thorium-230, also exceeded both background screening levels and the SSL for protection of RGA groundwater.

There are several cesium-137 exceedances, predominantly along the periphery of SWMU 4, associated with sampling under the Surface Water Operable Unit (SWOU). It was noted in the SWOU Site Investigation/Baseline Risk Assessment that data for cesium-137 and uranium-238 for the SWOU were produced using an *In Situ* Object Counting System (ISOCS) unit, as opposed to a fixed-base laboratory. The data are considered screening level only (its intended purpose) and did not meet data evaluation methods for this project. These data subsequently were removed from the SWMU 4 data set.

### 4.3 SUBSURFACE SOILS

The subsurface soil data summary presented in Table 4.5 provides the nature of the contamination in SWMU 4 subsurface soils [only results from the 1-ft to 20-ft bgs interval are compared to the excavation worker risk screening values (see Section 4.1), while results from the entire interval from 1 ft to the base of the UCRS (considered to be 60 ft depth for screening) are compared to both background and groundwater protection SSLs]. The summary table is based on both historical and BGOU RI Addendum soil sample data and presents min, max, and avg values of the detected results, FODs, and FOEs as compared to screening values shown in Tables 4.2 through 4.3, and the DL range. Figure 4.4 illustrates the subsurface soil sampling at SWMU 4 and segregates the sample location with an associated burial cell. Tables 4.6–4.10 provide the data for Burial Cells 1 through 5, respectively, while Table 4.11 provides the data for inter-cell sample locations (i.e., sample locations not located within the burial cell boundaries). Tables 4.6 through 4.11 provide the sample depth information for each location for 1–60 ft bgs with color coding to identify sample results exceeding excavation worker NAL/AL and/or background values (color coding is independent of risk screening). Also shown are sample results exceeding RGA SSLs, if the result did not exceed the excavation worker NAL or background value. Table 4.12 shows soil sample depth information and results for each location in which samples were collected below 60 ft bgs.

#### Metals

The following metals were detected in subsurface soil at concentrations above both background screening levels and the excavation worker NALs: arsenic, cobalt, iron, manganese, nickel, and uranium. Both cobalt and manganese exceeded background in fewer than five percent of the analyses. Only iron, nickel, and uranium exceeded background in more than 10% of the analyses. Beryllium exceeded background in more than 30% of the analyses, but it did not exceed any of the excavation worker risk screening levels.

Arsenic exceeded background in almost eight percent of the analyses and six analyses (2%) exceeded twice background. Five of those exceeding twice background were associated with Burial Cell 4 and varied in depth from 1 to 55 ft bgs. Cadmium exceeded background in approximately eight percent of the analyses, but did not exceed the excavation worker risk levels. Iron, which exceeded both background and excavation worker NAL in approximately 10% of the samples, ranged from 3,220 to 87,700 mg/kg. Iron exceeded twice background levels in two samples, both associated with Burial Cell 4. Nickel exceeded background in 36 of 268 analyses (13%) and exceeded twice background in 15 analyses (6%). The maximum concentration of nickel, 3,230 mg/kg, was detected in Burial Cell 4 in the 5- to 10-ft depth interval.

Table 4.5. SWMU 4 Subsurface Soil (1-60 ft bgs) Data Summary<sup>a</sup>

Type	Analysis	Unit	Detected Results			FOD	Background	Excavation Worker <sup>b</sup>		GW Protection Screen		DL Range
			Min	Max	Avg		FOE	NAL FOE	AL FOE	RGA	UCRS	
METAL	Aluminum	mg/kg	2.08E+03	2.64E+04	9.72E+03	132/132	23/132	0/63	0/63	0/132	128/132	20 - 20
METAL	Antimony	mg/kg	N/A	N/A	N/A	0/132	0/132	0/63	0/63	0/132	0/132	20 - 20
METAL	Arsenic	mg/kg	7.20E-01	2.28E+01	5.02E+00	128/267	21/267	47/143	0/143	5/267	128/267	0.17 - 5
METAL	Barium	mg/kg	4.72E+00	1.32E+03	7.04E+01	268/268	12/268	0/143	0/143	0/268	70/268	0.084 - 5.53
METAL	Beryllium	mg/kg	2.50E-01	2.36E+00	7.80E-01	161/268	83/268	0/143	0/143	0/268	0/268	0.042 - 1.6
METAL	Cadmium	mg/kg	2.30E-02	1.56E+01	1.67E+00	33/268	22/268	0/143	0/143	0/268	22/268	0.025 - 2
METAL	Calcium	mg/kg	1.28E+02	1.31E+05	2.28E+03	132/132	2/132	N/A	N/A	N/A	N/A	50 - 100
METAL	Chromium	mg/kg	2.55E+00	3.93E+02	1.81E+01	268/268	18/268	0/143	0/143	0/268	0/268	0.84 - 11.7
METAL	Cobalt	mg/kg	1.01E+00	3.16E+01	5.02E+00	130/132	5/132	4/63	0/63	127/132	130/132	1 - 2
METAL	Copper	mg/kg	2.11E+00	1.13E+03	1.68E+01	127/132	4/132	0/63	0/63	0/132	3/132	2 - 2
METAL	Cyanide	mg/kg	N/A	N/A	N/A	0/129	N/A	0/129	0/129	0/129	0/129	1 - 1
METAL	Iron	mg/kg	3.22E+03	8.77E+04	1.51E+04	268/268	27/268	13/143	0/143	268/268	268/268	0.0084 - 111
METAL	Lead	mg/kg	1.40E+00	1.30E+02	1.14E+01	138/268	11/268	0/143	0/143	0/268	18/268	0.042 - 20
METAL	Magnesium	mg/kg	7.82E+01	2.65E+03	9.47E+02	131/132	6/132	N/A	N/A	N/A	N/A	15 - 15
METAL	Manganese	mg/kg	1.29E+01	8.49E+03	2.78E+02	267/268	13/268	11/143	0/143	112/268	267/268	0.17 - 111
METAL	Mercury	mg/kg	1.80E-02	3.53E+00	2.97E-01	40/197	9/197	0/128	0/128	2/197	28/197	0.014 - 0.2
METAL	Nickel	mg/kg	1.40E+00	3.23E+03	6.14E+01	226/268	36/268	7/143	0/143	9/268	224/268	0.42 - 116
METAL	Potassium	mg/kg	1.09E+02	6.40E+03	5.74E+02	131/132	11/132	N/A	N/A	N/A	N/A	100 - 100
METAL	Selenium	mg/kg	1.60E-01	1.20E+00	5.55E-01	33/267	8/267	0/143	0/143	0/267	29/267	0.084 - 3.21
METAL	Silver	mg/kg	2.80E-03	1.89E+01	1.06E+00	32/268	2/268	0/143	0/143	2/268	6/268	0.0084 - 4
METAL	Sodium	mg/kg	2.00E+02	3.15E+03	4.32E+02	104/132	52/132	N/A	N/A	N/A	N/A	200 - 200
METAL	Thallium	mg/kg	N/A	N/A	N/A	0/132	0/132	0/63	0/63	0/132	0/132	15 - 15
METAL	Uranium	mg/kg	3.40E-01	1.11E+04	4.25E+02	103/136	48/136	17/80	4/80	9/136	38/136	0.0084 - 124
METAL	Vanadium	mg/kg	4.26E+00	1.00E+02	2.25E+01	267/268	23/268	0/143	0/143	0/268	263/268	0.084 - 23.4
METAL	Zinc	mg/kg	1.51E+01	7.97E+01	3.37E+01	109/132	9/132	0/63	0/63	0/132	31/132	15 - 20
PPCB	PCB, Total	mg/kg	2.50E-02	3.80E+01	3.63E+00	38/295	N/A	12/166	0/166	8/295	35/295	0.05 - 61.8
SVOA	1,2,4-Trichlorobenzene	mg/kg	N/A	N/A	N/A	0/123	N/A	N/A	N/A	N/A	N/A	0.39 - 0.5
SVOA	1,2-Dichlorobenzene	mg/kg	N/A	N/A	N/A	0/123	N/A	N/A	N/A	N/A	N/A	0.39 - 0.5
SVOA	1,3-Dichlorobenzene	mg/kg	N/A	N/A	N/A	0/123	N/A	N/A	N/A	N/A	N/A	0.39 - 0.5
SVOA	1,4-Dichlorobenzene	mg/kg	N/A	N/A	N/A	0/123	N/A	N/A	N/A	N/A	N/A	0.39 - 0.5
SVOA	2,4,5-Trichlorophenol	mg/kg	N/A	N/A	N/A	0/123	N/A	N/A	N/A	N/A	N/A	0.39 - 0.5
SVOA	2,4,6-Trichlorophenol	mg/kg	N/A	N/A	N/A	0/123	N/A	N/A	N/A	N/A	N/A	0.39 - 0.5
SVOA	2,4-Dichlorophenol	mg/kg	N/A	N/A	N/A	0/123	N/A	N/A	N/A	N/A	N/A	0.39 - 0.5
SVOA	2,4-Dimethylphenol	mg/kg	N/A	N/A	N/A	0/123	N/A	N/A	N/A	N/A	N/A	0.39 - 0.5
SVOA	2,4-Dinitrophenol	mg/kg	N/A	N/A	N/A	0/52	N/A	N/A	N/A	N/A	N/A	0.39 - 0.5
SVOA	2,4-Dinitrotoluene	mg/kg	N/A	N/A	N/A	0/123	N/A	N/A	N/A	N/A	N/A	0.39 - 0.5
SVOA	2,6-Dinitrotoluene	mg/kg	N/A	N/A	N/A	0/123	N/A	N/A	N/A	N/A	N/A	0.39 - 0.5
SVOA	2-Chloronaphthalene	mg/kg	N/A	N/A	N/A	0/123	N/A	N/A	N/A	N/A	N/A	0.39 - 0.5
SVOA	2-Chlorophenol	mg/kg	N/A	N/A	N/A	0/123	N/A	N/A	N/A	N/A	N/A	0.39 - 0.5
SVOA	2-Methyl-4,6-dinitrophenol	mg/kg	N/A	N/A	N/A	0/122	N/A	N/A	N/A	N/A	N/A	0.39 - 0.5
SVOA	2-Methylnaphthalene	mg/kg	N/A	N/A	N/A	0/123	N/A	N/A	N/A	N/A	N/A	0.39 - 0.5

Table 4.5. SWMU 4 Subsurface Soil (1-60 ft bgs) Data Summary<sup>a</sup> (Continued)

Type	Analysis	Unit	Detected Results			FOD	Background	Excavation Worker <sup>b</sup>		GW Protection Screen		DL Range
			Min	Max	Avg		FOE	NAL FOE	AL FOE	RGA	UCRS	
SVOA	2-Methylphenol	mg/kg	N/A	N/A	N/A	0/123	N/A	N/A	N/A	N/A	N/A	0.39 - 0.5
SVOA	2-Nitrobenzenamine	mg/kg	N/A	N/A	N/A	0/203	N/A	0/139	0/139	0/203	0/203	0.39 - 1.6
SVOA	2-Nitrophenol	mg/kg	N/A	N/A	N/A	0/123	N/A	N/A	N/A	N/A	N/A	0.39 - 0.5
SVOA	3,3'-Dichlorobenzidine	mg/kg	N/A	N/A	N/A	0/123	N/A	N/A	N/A	N/A	N/A	0.39 - 0.5
SVOA	3-Nitrobenzenamine	mg/kg	N/A	N/A	N/A	0/123	N/A	N/A	N/A	N/A	N/A	0.39 - 0.5
SVOA	4-Bromophenyl phenyl ether	mg/kg	N/A	N/A	N/A	0/123	N/A	N/A	N/A	N/A	N/A	0.39 - 0.5
SVOA	4-Chloro-3-methylphenol	mg/kg	N/A	N/A	N/A	0/123	N/A	N/A	N/A	N/A	N/A	0.39 - 0.5
SVOA	4-Chlorobenzenamine	mg/kg	N/A	N/A	N/A	0/123	N/A	N/A	N/A	N/A	N/A	0.39 - 0.5
SVOA	4-Chlorophenyl phenyl ether	mg/kg	N/A	N/A	N/A	0/123	N/A	N/A	N/A	N/A	N/A	0.39 - 0.5
SVOA	4-Methylphenol	mg/kg	N/A	N/A	N/A	0/123	N/A	N/A	N/A	N/A	N/A	0.39 - 0.5
SVOA	4-Nitrophenol	mg/kg	N/A	N/A	N/A	0/123	N/A	N/A	N/A	N/A	N/A	0.39 - 0.5
SVOA	Acenaphthene	mg/kg	N/A	N/A	N/A	0/203	N/A	0/139	0/139	0/203	0/203	0.39 - 1.6
SVOA	Acenaphthylene	mg/kg	N/A	N/A	N/A	0/203	N/A	0/139	0/139	N/A	N/A	0.39 - 1.6
SVOA	Anthracene	mg/kg	N/A	N/A	N/A	0/203	N/A	0/139	0/139	0/203	0/203	0.39 - 1.6
SVOA	Benzo(ghi)perylene	mg/kg	N/A	N/A	N/A	0/123	N/A	N/A	N/A	N/A	N/A	0.39 - 0.5
SVOA	Bis(2-chloroethoxy)methane	mg/kg	N/A	N/A	N/A	0/123	N/A	N/A	N/A	N/A	N/A	0.39 - 0.5
SVOA	Bis(2-chloroethyl) ether	mg/kg	N/A	N/A	N/A	0/123	N/A	N/A	N/A	N/A	N/A	0.39 - 0.5
SVOA	Bis(2-chloroisopropyl) ether	mg/kg	N/A	N/A	N/A	0/123	N/A	N/A	N/A	N/A	N/A	0.39 - 0.5
SVOA	Bis(2-ethylhexyl)phthalate	mg/kg	1.74E-01	7.47E-01	3.96E-01	7/123	N/A	0/59	0/59	0/123	0/123	0.39 - 0.5
SVOA	Butyl benzyl phthalate	mg/kg	N/A	N/A	N/A	0/52	N/A	N/A	N/A	N/A	N/A	0.39 - 0.5
SVOA	Carbazole	mg/kg	N/A	N/A	N/A	0/203	N/A	0/139	0/139	0/203	0/203	0.39 - 1.6
SVOA	Dibenzofuran	mg/kg	N/A	N/A	N/A	0/123	N/A	N/A	N/A	N/A	N/A	0.39 - 0.5
SVOA	Diethyl phthalate	mg/kg	2.04E-01	2.80E+00	1.50E+00	2/123	N/A	N/A	N/A	N/A	N/A	0.39 - 0.5
SVOA	Dimethyl phthalate	mg/kg	N/A	N/A	N/A	0/123	N/A	N/A	N/A	N/A	N/A	0.39 - 0.5
SVOA	Di-n-butyl phthalate	mg/kg	2.11E-01	6.10E+00	1.64E+00	24/123	N/A	N/A	N/A	N/A	N/A	0.39 - 0.5
SVOA	Di-n-octylphthalate	mg/kg	N/A	N/A	N/A	0/123	N/A	N/A	N/A	N/A	N/A	0.39 - 0.5
SVOA	Fluoranthene	mg/kg	6.50E-01	6.50E-01	6.50E-01	1/203	N/A	0/139	0/139	0/203	0/203	0.39 - 1.6
SVOA	Fluorene	mg/kg	N/A	N/A	N/A	0/123	N/A	0/59	0/59	0/123	0/123	0.39 - 0.5
SVOA	Hexachlorobenzene	mg/kg	N/A	N/A	N/A	0/203	N/A	0/139	0/139	0/203	0/203	0.39 - 1.6
SVOA	Hexachlorobutadiene	mg/kg	N/A	N/A	N/A	0/123	N/A	N/A	N/A	N/A	N/A	0.39 - 0.5
SVOA	Hexachlorocyclopentadiene	mg/kg	N/A	N/A	N/A	0/123	N/A	N/A	N/A	N/A	N/A	0.39 - 0.5
SVOA	Hexachloroethane	mg/kg	N/A	N/A	N/A	0/123	N/A	N/A	N/A	N/A	N/A	0.39 - 0.5
SVOA	Isophorone	mg/kg	N/A	N/A	N/A	0/123	N/A	N/A	N/A	N/A	N/A	0.39 - 0.5
SVOA	Naphthalene	mg/kg	9.90E+00	9.90E+00	9.90E+00	1/203	N/A	0/139	0/139	1/203	1/203	0.39 - 1.6
SVOA	Nitrobenzene	mg/kg	N/A	N/A	N/A	0/123	N/A	N/A	N/A	N/A	N/A	0.39 - 0.5
SVOA	N-Nitroso-di-n-propylamine	mg/kg	N/A	N/A	N/A	0/203	N/A	0/139	0/139	0/203	0/203	0.39 - 1.6
SVOA	N-Nitrosodiphenylamine	mg/kg	N/A	N/A	N/A	0/123	N/A	N/A	N/A	N/A	N/A	0.39 - 0.5
SVOA	Pentachlorophenol	mg/kg	N/A	N/A	N/A	0/123	N/A	0/59	0/59	0/123	0/123	0.39 - 0.5
SVOA	Phenanthrene	mg/kg	N/A	N/A	N/A	0/203	N/A	0/139	0/139	0/203	0/203	0.39 - 1.6
SVOA	Phenol	mg/kg	N/A	N/A	N/A	0/123	N/A	N/A	N/A	N/A	N/A	0.39 - 0.5
SVOA	p-Nitroaniline	mg/kg	N/A	N/A	N/A	0/123	N/A	N/A	N/A	N/A	N/A	0.39 - 0.5

Table 4.5. SWMU 4 Subsurface Soil (1-60 ft bgs) Data Summary<sup>a</sup> (Continued)

Type	Analysis	Unit	Detected Results			FOD	Background	Excavation Worker <sup>b</sup>		GW Protection Screen		DL Range
			Min	Max	Avg		FOE	NAL FOE	AL FOE	RGA	UCRS	
SVOA	Pyrene	mg/kg	6.70E-01	7.10E-01	6.90E-01	2/203	N/A	0/139	0/139	0/203	0/203	0.39 - 1.6
SVOA	Pyridine	mg/kg	N/A	N/A	N/A	0/32	N/A	N/A	N/A	N/A	N/A	0.39 - 0.5
SVOA	Total PAH	mg/kg	N/A	N/A	N/A	0/203	N/A	0/139	0/139	0/203	0/203	-
VOA	1,1,1-Trichloroethane	mg/kg	N/A	N/A	N/A	0/114	N/A	0/54	0/54	0/114	0/114	0.01 - 0.01
VOA	1,1,2,2-Tetrachloroethane	mg/kg	N/A	N/A	N/A	0/114	N/A	N/A	N/A	N/A	N/A	0.01 - 0.01
VOA	1,1,2-Trichloro-1,2,2-trifluoroethane	mg/kg	5.12E-03	3.90E+00	8.55E-01	9/202	N/A	0/88	0/88	0/202	0/202	0.0042 - 2.39
VOA	1,1,2-Trichloroethane	mg/kg	2.10E-02	2.10E-02	2.10E-02	1/114	N/A	0/54	0/54	0/114	1/114	0.01 - 0.01
VOA	1,1-Dichloroethane	mg/kg	N/A	N/A	N/A	0/112	N/A	0/54	0/54	0/112	0/112	0.01 - 0.01
VOA	1,1-Dichloroethene	mg/kg	3.36E-04	2.10E-02	4.39E-03	27/400	N/A	0/184	0/184	0/400	11/400	0.000885 - 0.539
VOA	1,2-Dichloroethane	mg/kg	N/A	N/A	N/A	0/114	N/A	0/54	0/54	0/114	0/114	0.01 - 0.01
VOA	1,2-Dichloropropane	mg/kg	N/A	N/A	N/A	0/114	N/A	N/A	N/A	N/A	N/A	0.01 - 0.01
VOA	1,2-Dimethylbenzene	mg/kg	4.01E-04	9.30E+00	1.64E+00	10/316	N/A	0/142	0/142	2/316	4/316	0.000885 - 0.479
VOA	2-Butanone	mg/kg	N/A	N/A	N/A	0/115	N/A	N/A	N/A	N/A	N/A	0.01 - 0.01
VOA	2-Hexanone	mg/kg	N/A	N/A	N/A	0/115	N/A	N/A	N/A	N/A	N/A	0.01 - 0.01
VOA	4-Methyl-2-pentanone	mg/kg	N/A	N/A	N/A	0/114	N/A	N/A	N/A	N/A	N/A	0.01 - 0.01
VOA	Acetone	mg/kg	1.20E-02	1.20E-02	1.20E-02	1/92	N/A	N/A	N/A	N/A	N/A	0.01 - 0.01
VOA	Acrylonitrile	mg/kg	N/A	N/A	N/A	0/202	N/A	0/88	0/88	0/202	0/202	0.00442 - 4.1
VOA	Benzene	mg/kg	2.87E-04	2.12E-01	2.75E-02	14/316	N/A	0/142	0/142	2/316	3/316	0.000885 - 0.479
VOA	Bromodichloromethane	mg/kg	N/A	N/A	N/A	0/114	N/A	0/54	0/54	0/114	0/114	0.01 - 0.01
VOA	Bromoform	mg/kg	N/A	N/A	N/A	0/114	N/A	N/A	N/A	N/A	N/A	0.01 - 0.01
VOA	Bromomethane	mg/kg	N/A	N/A	N/A	0/114	N/A	N/A	N/A	N/A	N/A	0.01 - 0.01
VOA	Carbon disulfide	mg/kg	N/A	N/A	N/A	0/114	N/A	N/A	N/A	N/A	N/A	0.01 - 0.01
VOA	Carbon tetrachloride	mg/kg	1.03E-03	5.10E+00	5.28E-01	12/316	N/A	0/142	0/142	7/316	11/316	0.000885 - 0.591
VOA	Chlorobenzene	mg/kg	N/A	N/A	N/A	0/114	N/A	N/A	N/A	N/A	N/A	0.01 - 0.01
VOA	Chloroethane	mg/kg	N/A	N/A	N/A	0/114	N/A	N/A	N/A	N/A	N/A	0.01 - 0.01
VOA	Chloroform	mg/kg	3.85E-04	4.00E+00	4.35E-01	26/315	N/A	0/142	0/142	3/315	10/315	0.000885 - 0.558
VOA	Chloromethane	mg/kg	N/A	N/A	N/A	0/114	N/A	N/A	N/A	N/A	N/A	0.01 - 0.01
VOA	cis-1,2-Dichloroethene	mg/kg	6.19E-04	1.42E+01	8.71E-01	113/400	N/A	0/184	0/184	17/400	83/400	0.000885 - 4.1
VOA	cis-1,3-Dichloropropene	mg/kg	N/A	N/A	N/A	0/115	N/A	N/A	N/A	N/A	N/A	0.01 - 0.01
VOA	Dibromochloromethane	mg/kg	N/A	N/A	N/A	0/114	N/A	N/A	N/A	N/A	N/A	0.01 - 0.01
VOA	Dichlorodifluoromethane	mg/kg	N/A	N/A	N/A	0/202	N/A	0/88	0/88	0/202	0/202	0.000885 - 0.591
VOA	Ethylbenzene	mg/kg	6.73E-04	3.02E+00	1.05E+00	5/316	N/A	0/142	0/142	0/316	2/316	0.000885 - 0.479
VOA	m,p-Xylene	mg/kg	4.03E-04	1.66E+01	3.77E+00	8/316	N/A	0/142	0/142	0/316	2/316	0.00177 - 0.957
VOA	Methylene chloride	mg/kg	1.60E-02	5.40E-02	3.52E-02	18/114	N/A	N/A	N/A	N/A	N/A	0.01 - 0.01
VOA	Styrene	mg/kg	N/A	N/A	N/A	0/114	N/A	N/A	N/A	N/A	N/A	0.01 - 0.01

Table 4.5. SWMU 4 Subsurface Soil (1-60 ft bgs) Data Summary<sup>a</sup> (Continued)

Type	Analysis	Unit	Detected Results			FOD	Background	Excavation Worker <sup>b</sup>		GW Protection Screen		DL Range
			Min	Max	Avg		FOE	NAL FOE	AL FOE	RGA	UCRS	
VOA	Tetrachloroethene	mg/kg	3.65E-04	7.00E-01	3.58E-02	20/316	N/A	0/142	0/142	1/316	2/316	0.000885 - 0.479
VOA	Toluene	mg/kg	3.15E-04	2.30E+00	4.08E-01	10/316	N/A	0/142	0/142	0/316	2/316	0.000885 - 0.479
VOA	Total Xylene	mg/kg	4.03E-04	2.59E+01	3.89E+00	12/202	N/A	0/88	0/88	0/202	2/202	0.00265 - 1.44
VOA	<i>trans</i> -1,2-Dichloroethene	mg/kg	4.50E-01	4.50E-01	4.50E-01	1/198	N/A	0/96	0/96	0/198	1/198	0.01 - 0.539
VOA	<i>trans</i> -1,3-Dichloropropene	mg/kg	N/A	N/A	N/A	0/114	N/A	N/A	N/A	N/A	N/A	0.01 - 0.01
VOA	Trichloroethene	mg/kg	1.18E-03	7.50E+02	7.34E+00	124/400	N/A	0/184	0/184	63/400	123/400	0.0008 - 41
VOA	Vinyl chloride	mg/kg	7.91E-04	2.80E+00	1.18E-01	67/400	N/A	0/184	0/184	23/400	67/400	0.000885 - 30
RADS	Alpha activity	pCi/g	1.17E+00	3.08E+03	4.28E+01	191/199	N/A	N/A	N/A	N/A	N/A	0.34 - 16
RADS	Americium-241	pCi/g	8.11E-01	1.06E+01	4.74E+00	3/331	N/A	0/180	0/180	0/331	2/331	0.0306 - 15
RADS	Beta activity	pCi/g	7.60E-01	3.25E+03	5.36E+01	194/199	N/A	N/A	N/A	N/A	N/A	0.13 - 11
RADS	Cesium-137	pCi/g	3.32E-02	4.60E+01	2.36E+00	25/301	12/301	5/169	0/169	1/301	8/301	0.0172 - 3.9
RADS	Cobalt-60	pCi/g	N/A	N/A	N/A	0/300	N/A	N/A	N/A	N/A	N/A	0.0161 - 6.1
RADS	Neptunium-237	pCi/g	8.35E-03	1.00E+02	4.72E+00	37/170	N/A	7/95	0/95	4/170	34/170	0.0267 - 0.221
RADS	Plutonium-238	pCi/g	2.35E-02	8.27E-01	1.95E-01	5/133	N/A	0/77	0/77	0/133	1/133	0.0131 - 0.0651
RADS	Plutonium-239/240	pCi/g	2.65E-02	7.11E+01	3.09E+00	29/171	N/A	1/96	0/96	1/171	13/171	0.0159 - 0.086
RADS	Protactinium-234m	pCi/g	1.34E+02	3.80E+02	2.57E+02	2/167	N/A	N/A	N/A	N/A	N/A	22 - 840
RADS	Radium-226	pCi/g	3.04E-01	2.51E+00	1.50E+00	17/37	8/37	N/A	N/A	N/A	N/A	0.145 - 1.01
RADS	Technetium-99	pCi/g	7.80E-01	1.05E+03	7.00E+01	44/324	32/324	0/177	0/177	44/324	44/324	0.678 - 6.97
RADS	Thorium-230	pCi/g	3.22E-01	7.27E+02	7.28E+00	135/135	16/135	2/79	0/79	1/135	14/135	0.109 - 0.541
RADS	Thorium-234	pCi/g	6.03E-01	2.17E+02	4.62E+01	28/198	N/A	N/A	N/A	N/A	N/A	0.261 - 41
RADS	Uranium-234	pCi/g	2.67E-01	4.17E+03	4.41E+01	150/170	66/170	10/95	0/95	47/170	150/170	0.00771 - 3.89
RADS	Uranium-235	pCi/g	1.35E-02	2.60E+02	3.40E+00	121/300	60/300	9/168	1/168	9/300	69/300	0.00697 - 9.8
RADS	Uranium-238	pCi/g	2.78E-01	6.21E+03	7.77E+01	150/170	70/170	34/95	3/95	58/170	150/170	0.00777 - 4.03

One or more samples exceed AL value  
 One or more samples exceed NAL value  
 One or more samples exceed background value  
 One or more samples exceed SSLs of RGA and UCRS groundwater protection

Counts of analyses are based on the maximum detected result from a sample (i.e., if a sample has analytical results from two different labs, only the maximum value is counted). Field replicates, or separate samples are counted independently.

The uranium (metal)/uranium (isotopic) may not be from the same sample thus a correlation between uranium (metal)/uranium (isotopic) data may not be possible. Uranium-238 that was analyzed using method RL-7128NITRIC is compared to a background value of 0.4 pCi/g for surface and subsurface (DOE 2009).

<sup>a</sup> Top of the RGA is assumed to be 60 ft bgs.

<sup>b</sup> Frequencies of exceedance for excavation worker NAL and AL are compared only to samples collected 1–20 ft bgs.

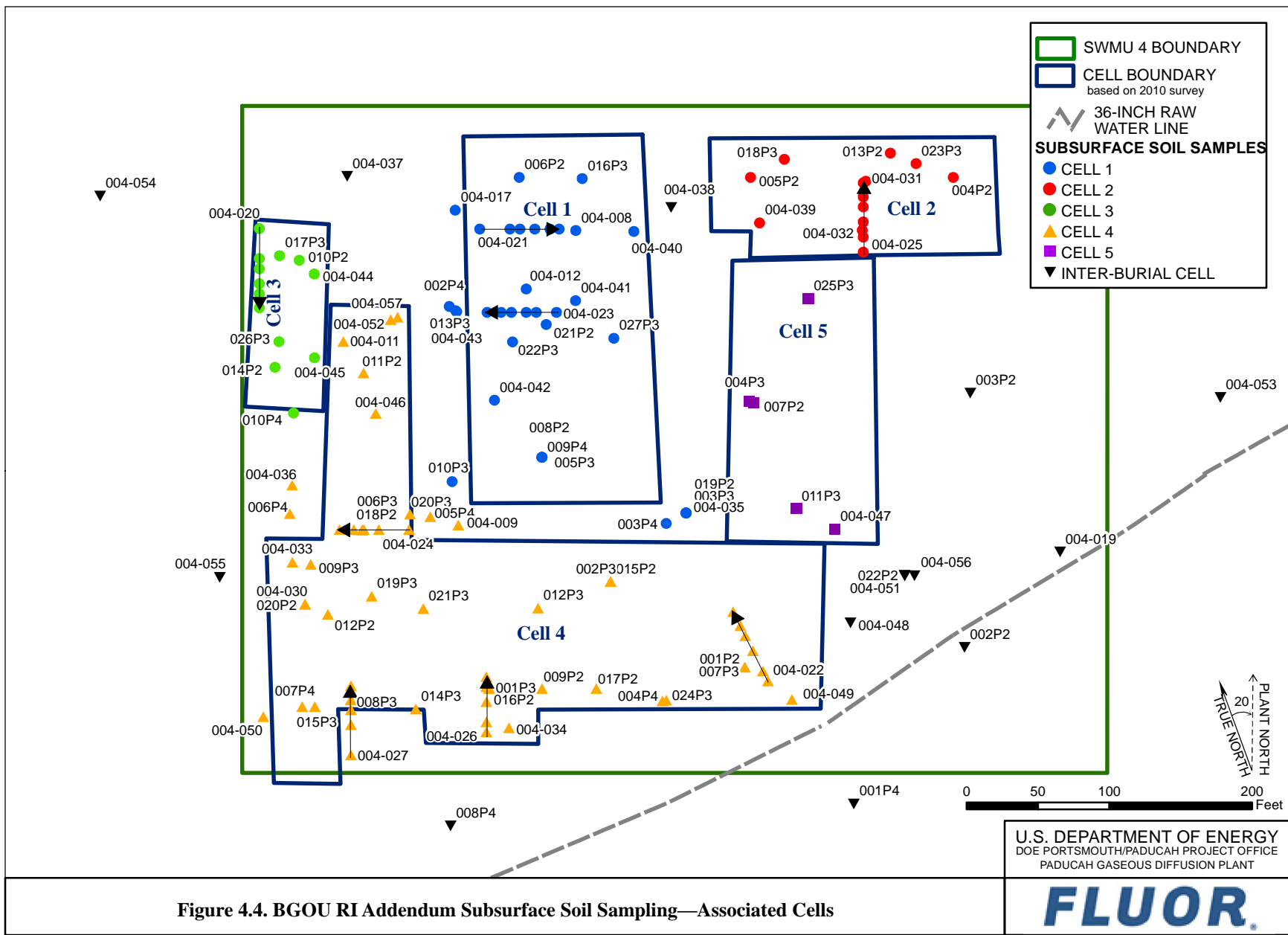

Figure 4.4. BGOU RI Addendum Subsurface Soil Sampling—Associated Cells

Table 4.6. Burial Cell 1 Sample Locations and Depths of the Contaminants Detected above Screening Levels in SWMU 4 for Soil 1–60 ft bgs

Color coding described in table end notes.

Analysis	ft bgs	Historical Soil Sampling Locations										Phase 2 Soil Sampling Locations				Phase 3 Soil Sampling Locations						
		004-008	004-012	004-017	004-021	004-023	004-035	004-040	004-041	004-042	004-043	004-006P2	004-008P2	004-019P2	004-021P2	004-003P3	004-005P3	004-010P3	004-013P3	004-016P3	004-022P3	004-027P3
<i>Metals (mg/kg)</i>																						
Arsenic	01-05						ND					7.48			3.13							
	05-10			8.29		ND	ND	ND	ND	ND	ND	4.6	1.64	2.15	8.02							
	10-15	ND					ND	ND	ND	ND	ND	3.44	3.24	1.8	2.41							
	15-20	ND		ND								ND	3.35	ND	1.83							
	20-25			ND			ND	ND		ND	ND					ND				1.3	2.3	1.2
	25-30															3.76	6.75	2.4				
	30-35				ND	ND																
	35-40			ND																		
	40-45				6.13	ND																
	45-50			ND																		
	50-55				ND	ND										5.39	ND	9.66	0.96	4.2	0.84	
55-60			ND	ND																	1.3	
Chromium	01-05						29.2					11.6			9.34							
	05-10			13.1		13.7	17.3	12.9	16.3	10.8	11.1	13.4	4.64	8.04	121							
	10-15	15.4					18.6	9.94	14.4	18.2	15.9	10.4	8.8	9.15	21.8							
	15-20	23.8		11.3								9.78	8.24	9.39	22.5							
	20-25			12.8			60.8	12.2		10.8	16.9					11.8				10	15	4.8
	25-30															87.3	18.7	12				
	30-35				9.79	20.9																
	35-40			2.55																		
	40-45				12.9	21.2																
	45-50			8.99																		
	50-55				13	13.1										10.5	6.62	6.13	8.7	16	7.1	
55-60			6.74	5.28																	10	
Cobalt	01-05						6.87															
	05-10			8.09		4.86	5.66	5.58	9.7	3.33	3.23											
	10-15	3.98					3.99	7.3	3.57	7.9	5.74											
	15-20	6.78		7.09																		
	20-25			4.81			5.13	5.97		3.91	4.94											
	30-35				3.64	2.39																
	35-40			3.14																		
	40-45				3.96	3.38																
	45-50			3.74																		
	50-55				6.42	7.1																
55-60			3.09	6.03																		
Iron	01-05						30200					15000			10400							
	05-10			21200		13000	15500	12300	7880	9470	8800	14800	3270	6280	46100							
	10-15	14500					11700	7550	8940	21500	9250	12000	15400	6400	13400							
	15-20	8360		9210								6030	18200	8270	20400							
	20-25			18700			27800	10700		7170	24300					6660				6000	9500	4700
	25-30															17200	19500	15000				
	30-35				31800	21100																
	35-40			7410																		
	40-45				25800	28600																
	45-50			16600																		
	50-55				28900	28900										14200	7880	22500	13000	31000	15000	
55-60			11100	8670																	12000	

Table 4.6. Burial Cell 1 Sample Locations and Depths of the Contaminants Detected above Screening Levels in SWMU 4 for Soil 1–60 ft bgs (Continued)

Analysis	ft bgs	Historical Soil Sampling Locations										Phase 2 Soil Sampling Locations				Phase 3 Soil Sampling Locations							
		004-008	004-012	004-017	004-021	004-023	004-035	004-040	004-041	004-042	004-043	004-006P2	004-008P2	004-019P2	004-021P2	004-003P3	004-005P3	004-010P3	004-013P3	004-016P3	004-022P3	004-027P3	
Manganese	01-05						292					337		282									
	05-10			207		426	126	131	129	740	119	430	44.9	128	116								
	10-15	103					83.1	53.1	55.4	193	87.3	119	174	59.8	200								
	15-20	68.2		229								159	144	76.3	225								
	20-25			213			88.4	492		80.9	70.3					77.8				26	46	41	
	25-30																44.4	293	380				
	30-35				42.3	88.2																	
	35-40			188																			
	40-45				44.6	43.4																	
	45-50			240																			
	50-55				83	95.2										44.2	20.7	421	240	99	61		
55-60			51.4	37.9																		170	
Mercury	01-05						ND					0.036		0.077									
	05-10			ND		ND	ND	ND	ND	ND	ND	0.035		0.073									
	10-15	ND					ND	ND	ND	ND	ND	0.018		0.045									
	15-20	ND		ND								ND	0.03	ND									
	20-25			ND			ND	ND		ND	ND												
	30-35				ND	ND																	
	35-40			ND																			
	40-45				ND	ND																	
	45-50			ND																			
	50-55				ND	ND																	
	55-60			ND	ND																		
Nickel	01-05						16.9					33.5		19.8									
	05-10			5.34		13.8	12.7	39.6	9.79	7.25	7.59	19	3.97	6.1	1030								
	10-15	7.03					11.4	6.62	10.5	6.69	8.1	14.2	13	7.15	54.5								
	15-20	593		8.47								5.87	8.62	7.38	17.4								
	20-25			ND			ND	ND		ND	ND					8.72				3.8	24	2.6	
	25-30																6.49	6.78	3.8				
	30-35				ND	ND																	
	35-40			ND																			
	40-45				10.3	9																	
	45-50			5.34																			
	50-55				15.8	9.52										5.42	5.46	6.42	4.9	15	5.5		
55-60			7.23	ND																		9	
Silver	01-05						ND					ND		ND									
	05-10			ND		ND	ND	ND	ND	ND	ND	ND	ND	ND	ND								
	10-15	ND					ND	ND	ND	ND	ND	ND	ND	ND									
	15-20	ND		ND								ND	ND	ND	ND								
	20-25			ND			ND	ND		ND	ND					ND				0.012	0.079	0.012	
	25-30																ND	ND	0.0047				
	30-35				ND	ND																	
	35-40			ND																			
	40-45				ND	ND																	
	45-50			ND																			
	50-55				ND	ND										ND	ND	ND	ND	0.0091	ND		
55-60			ND	ND																		0.011	
Uranium	01-05											55.2		1.92									
	05-10											78.5	2.95	1.91	229								
	10-15											75	ND	ND	ND								
	15-20											73.8	ND	ND	2.76								
	20-25															14.5				0.66	41	0.93	
	25-30																ND	2.06	0.72				
	50-55															ND	ND	ND	0.7	1	0.73		
	55-60																						2.3



Table 4.6. Burial Cell 1 Sample Locations and Depths of the Contaminants Detected above Screening Levels in SWMU 4 for Soil 1–60 ft bgs (Continued)

Analysis	ft bgs	Historical Soil Sampling Locations										Phase 2 Soil Sampling Locations				Phase 3 Soil Sampling Locations						
		004-008	004-012	004-017	004-021	004-023	004-035	004-040	004-041	004-042	004-043	004-006P2	004-008P2	004-019P2	004-021P2	004-003P3	004-005P3	004-010P3	004-013P3	004-016P3	004-022P3	004-027P3
<i>PCBs (mg/kg)</i>																						
PCB, Total	01-05					10.3						0.34			ND							
	05-10			ND		ND	4.3	ND	ND	ND	ND	ND	ND	ND	ND							
	10-15	ND					ND	ND	ND	ND	ND	ND	ND	ND								
	15-20	ND		ND								ND	ND	ND	ND							
	20-25			ND			ND	ND	ND	ND	ND					ND				ND	ND	ND
	25-30																ND	ND	ND			
	30-35				ND	ND																
	35-40			ND																		
	40-45				ND	ND																
	45-50			ND																		
	50-55				ND	ND										ND	ND	ND	ND	ND	ND	
55-60			ND	ND	ND																ND	
<i>VOAs (mg/kg)</i>																						
1,2-Dimethylbenzene	01-05						ND					ND			ND							
	05-10	ND	ND	ND		ND						ND	ND	ND	ND							
	10-15	ND										ND	ND	ND	ND			ND				
	15-20	ND		ND								ND	ND	ND	ND			ND				
	20-25			ND												ND				ND	ND	ND
	25-30																ND	ND	ND			
	30-35				ND	ND											ND	ND	ND		ND	
	35-40			ND												ND			ND	ND		ND
	40-45				ND	ND										ND	ND	ND	ND		ND	
	45-50			ND																	ND	ND
	50-55				ND	ND										ND	ND	ND	ND	ND	ND	
55-60			ND	ND	ND																ND	
Benzene	01-05						ND					ND			ND							
	05-10	ND	ND	ND		ND						ND	ND	ND	ND							
	10-15	ND										ND	ND	ND	ND			ND				
	15-20	ND		ND								ND	ND	ND	ND			ND				
	20-25			ND												0.000324				ND	ND	ND
	25-30																ND	ND	ND			
	30-35				ND	ND											ND	0.000287			ND	
	35-40			ND												ND			ND	ND		ND
	40-45				ND	ND										ND	ND	ND	ND		ND	
	45-50			ND																	ND	ND
	50-55				ND	ND										ND	ND	ND	ND	ND	ND	
55-60			ND	ND	ND																ND	
Carbon tetrachloride	01-05						ND					ND			ND							
	05-10	ND	ND	ND		ND						ND	ND	ND	ND							
	10-15	ND										ND	ND	ND	ND			ND				
	15-20	ND		ND								ND	ND	ND	ND			ND				
	20-25			ND												ND				ND	ND	ND
	25-30																ND	ND	ND			
	30-35				ND	ND											ND	ND			ND	
	35-40			ND												ND			ND	ND		ND
	40-45				ND	ND										ND	ND	ND	ND		ND	
	45-50			ND																	ND	ND
	50-55				ND	ND										ND	ND	ND	ND	ND	ND	
55-60			ND	ND	ND																ND	

Table 4.6. Burial Cell 1 Sample Locations and Depths of the Contaminants Detected above Screening Levels in SWMU 4 for Soil 1–60 ft bgs (Continued)

Analysis	ft bgs	Historical Soil Sampling Locations										Phase 2 Soil Sampling Locations				Phase 3 Soil Sampling Locations						
		004-008	004-012	004-017	004-021	004-023	004-035	004-040	004-041	004-042	004-043	004-006P2	004-008P2	004-019P2	004-021P2	004-003P3	004-005P3	004-010P3	004-013P3	004-016P3	004-022P3	004-027P3
Chloroform	01-05						ND					ND		ND								
	05-10	ND	ND	ND		ND						ND	ND	ND	ND							
	10-15	ND										ND	ND	ND	ND			ND				
	15-20	ND		ND								ND	ND	ND	ND			ND				
	20-25			ND												ND				ND	ND	ND
	25-30															0.000385	ND	ND				
	30-35				ND	ND										ND	0.00275				ND	
	35-40			ND												ND			ND	ND		ND
	40-45				ND	ND										ND	0.00155	ND	ND		ND	ND
	45-50			ND																ND		ND
	50-55				ND	ND										ND	0.00053	0.00767	ND	ND	ND	
55-60			ND	ND	ND																ND	
<i>cis</i> -1,2-DCE	01-05						ND					ND		ND								
	05-10	ND	ND	ND		ND	0.48		ND	ND	ND	ND	ND	ND								
	10-15	ND					0.41	ND	ND	ND	ND	ND	0.318	0.227	ND			0.00395				
	15-20	ND		ND								ND	0.562	0.477	ND			0.0397				
	20-25			ND	ND	ND	0.414	ND	ND	ND	ND					0.334				ND	ND	0.0048
	25-30									ND						0.122	0.0115	0.031				
	30-35				ND	ND										0.181	0.0656				ND	
	35-40			ND												0.206			0.047	ND		0.041
	40-45				ND	ND										0.0103	0.0505	0.0578	0.072		ND	
	45-50			ND																ND		0.018
	50-55				ND	ND										0.0769	0.0111	0.13	0.11	ND	ND	
55-60			ND	ND	ND																0.0045	
TCE	01-05						ND					ND		ND								
	05-10	ND	ND	ND		ND	ND		ND	ND	ND	ND	ND	ND								
	10-15	ND					ND	ND	ND	ND	ND	ND	0.609	ND	ND			ND				
	15-20	ND		ND								ND	1.5	ND	ND			0.021				
	20-25			ND	ND	ND	0.82	ND	ND	ND	ND					0.0666				ND	ND	ND
	25-30									ND							0.391	0.0175	0.12			
	30-35				0.06	ND											0.672	0.0759			ND	
	35-40			ND												5.27			0.25	ND		0.013
	40-45				ND	ND										0.0835	0.983	ND	0.35		ND	
	45-50			0.015																ND		0.023
	50-55				ND	ND										1.07	0.0948	0.277	1.1	ND	ND	
55-60			0.042	ND	ND																0.0086	
Vinyl chloride	01-05						ND					ND		ND								
	05-10	ND	ND	ND		ND	ND		ND	ND	ND	ND	ND	0.00588	ND							
	10-15	ND					ND	ND	ND	ND	ND	ND	ND	ND				0.00134				
	15-20	ND		ND								ND	ND	ND	ND			0.00759				
	20-25			ND	ND	ND	ND	ND	ND	ND	ND					0.0421				ND	ND	0.026
	25-30									ND							0.000936	0.00256	0.0045			
	30-35				ND	ND											0.000791	0.0705			ND	
	35-40			ND													ND		0.0098	ND		ND
	40-45				ND	ND										ND	ND	0.0086	0.017		ND	
	45-50			ND																ND		ND
	50-55				ND	ND										0.0109	ND	0.00949	0.0065	ND	ND	
55-60			ND	ND	ND																ND	

Table 4.6. Burial Cell 1 Sample Locations and Depths of the Contaminants Detected above Screening Levels in SWMU 4 for Soil 1–60 ft bgs (Continued)

Analysis	ft bgs	Historical Soil Sampling Locations										Phase 2 Soil Sampling Locations				Phase 3 Soil Sampling Locations						
		004-008	004-012	004-017	004-021	004-023	004-035	004-040	004-041	004-042	004-043	004-006P2	004-008P2	004-019P2	004-021P2	004-003P3	004-005P3	004-010P3	004-013P3	004-016P3	004-022P3	004-027P3
<i>Radionuclides (pCi/g)</i>																						
Cesium-137	01-05				ND		ND					0.0332			0.563							
	05-10	ND	ND	ND		ND	ND		ND	ND	ND	ND	ND	ND	46							
	10-15	ND					ND	ND	ND	ND	ND	ND	ND	ND	ND							
	15-20	ND		ND								ND	ND	ND	ND							
	20-25			ND		ND	ND	ND	ND	ND	ND					ND				ND	ND	ND
	25-30									ND							ND	ND	ND			
	30-35				ND	ND																
	35-40			ND																		
	40-45				ND	ND																
	45-50			ND																		
	50-55				ND	ND										ND	ND	ND	ND	ND	ND	
55-60			ND	ND	ND																ND	
Neptunium-237	01-05						1.02					0.198		ND								
	05-10	ND						5.78				ND	ND	ND	ND							
	10-15											ND	ND	ND	ND							
	15-20	ND										ND	ND	ND	ND							
	20-25															ND				0.142	ND	0.114
	25-30																ND	ND	ND			
	50-55															ND	ND	ND	ND	ND	0.122	
55-60																					ND	
Plutonium-239/240	01-05						0.152					0.0592		ND								
	05-10	ND						0.39				ND	ND	ND	0.0267							
	10-15											ND	ND	ND	ND							
	15-20	ND										ND	ND	ND	ND							
	20-25															ND				ND	ND	ND
	25-30																ND	ND	ND			
	50-55															ND	ND	ND	0.0527	ND	ND	
55-60																					ND	
Technetium-99	01-05				ND		5.7					2.82		ND								
	05-10	ND	ND	4.79		ND	ND	ND	ND	ND	ND	ND	ND	ND								
	10-15	ND					ND	ND	ND	ND	ND	ND	ND	ND								
	15-20	ND		ND								ND	ND	ND	ND							
	20-25			ND	ND	ND	ND	ND		ND	ND					ND				ND	1.27	ND
	25-30									ND							ND	ND	ND			
	30-35				ND	ND																
	35-40			ND																		
	40-45				ND	ND																
	45-50			ND																		
	50-55				ND	ND										0.78	ND	ND	ND	ND	ND	
55-60				ND	ND																ND	
Thorium-230	01-05											1.33		1.13								
	05-10						2.06					2.3	1.03	1.22	0.992							
	10-15											0.884	0.926	0.954	0.911							
	15-20											0.749	0.991	0.733	0.947							
	20-25															0.873				1.02	0.624	1.33
	25-30																0.483	0.726	0.494			
	50-55															0.815	0.553	0.417	0.601	0.96	1.02	
55-60																					0.912	

Table 4.6. Burial Cell 1 Sample Locations and Depths of the Contaminants Detected above Screening Levels in SWMU 4 for Soil 1–60 ft bgs (Continued)

Analysis	ft bgs	Historical Soil Sampling Locations										Phase 2 Soil Sampling Locations				Phase 3 Soil Sampling Locations							
		004-008	004-012	004-017	004-021	004-023	004-035	004-040	004-041	004-042	004-043	004-006P2	004-008P2	004-019P2	004-021P2	004-003P3	004-005P3	004-010P3	004-013P3	004-016P3	004-022P3	004-027P3	
Uranium-234	01-05						36.5					2.4		1.29									
	05-10	4.82						69				5.63	1.78	0.556	8.64								
	10-15											6.2	0.659	0.418	0.484								
	15-20	1.95										9.31	0.581	0.72	1.3								
	20-25															0.721				0.798	15.8	1.48	
	25-30																0.328	1.39	0.599				
	50-55															0.582	0.418	0.37	0.827	0.926	0.688		
	55-60																						1.15
Uranium-235	01-05				ND		ND					0.165		0.0753									
	05-10	ND	ND	ND		ND	ND		ND	ND	ND	0.391	0.114	0.0467	0.453								
	10-15	ND					ND	ND	ND	ND	ND	0.417	0.043	0.0266	ND								
	15-20	ND		ND								0.632	0.0268	0.038	0.0713								
	20-25			ND		ND	ND	ND	ND	ND	ND					0.0454				0.0372	1.03	0.0654	
	25-30									ND							ND	0.0921	ND				
	30-35				ND	ND																	
	35-40			ND																			
	40-45				ND	ND																	
	45-50			ND																			
50-55				ND	ND										0.0279	0.0264	ND	ND	0.0749	0.0516			
55-60			ND	ND	ND																	0.0485	
Uranium-238	01-05						75					5.35		1.63									
	05-10	6.08						92.7				7.42	3.09	1.08	8.99								
	10-15											8.68	0.825	0.548	0.534								
	15-20	2.15										11.2	0.807	0.782	1.48								
	20-25															0.974				0.89	17	1.43	
	25-30																0.305	1.9	0.541				
	50-55															0.515	0.452	0.408	0.959	0.921	0.795		
	55-60																						1.16

Blank cells indicate interval was not sampled for the specified analysis.

Maximum value shown for each depth interval.

"ND" indicates result was not detected.

Cell color coding:

Green indicates result is greater than excavation worker NAL (not greater than background).

Orange indicates result is greater than background value (not greater than excavation worker NAL).

Brown indicates result is greater than both excavation worker NAL and background values.

Blue indicates result is greater than RGA SSL.

(NOTE: Cell is color coded for exceeding RGA SSL only if result does not exceed NAL or background value.)

**Table 4.7. Burial Cell 2 Sample Locations and Depths of the Contaminants  
Detected above Screening Levels in SWMU 4 for Soil 1–60 ft bgs**

Color coding described in table end notes.

Analysis	ft bgs	Historical Soil Sampling Locations				Phase 2 Soil Sampling Locations			Phase 3 Soil Sampling Locations	
		004-025	004-031	004-032	004-039	004-004P2	004-005P2	004-013P2	004-018P3	004-023P3
<i>Metals (mg/kg)</i>										
Arsenic	01-05					4.39		1.74		
	05-10	7.28		ND		5.36	7.65	2.94		
	10-15				ND	1.97	ND	ND		
	15-20			ND		ND	ND	ND		
	20-25			ND						2.5
	25-30								7.7	
	30-35	ND			ND					
	35-40			ND						
	40-45	7.7								
	45-50			ND						
	50-55	ND							4	
55-60			ND						1	
Chromium	01-05					9.46		9.58		
	05-10	15.1		13.5		17.6	61.7	11.9		
	10-15				14.1	11.4	9.35	10		
	15-20			13.8		7.92	7.99	5.63		
	20-25			13.4						15
	25-30								84	
	30-35	14.9			9.49					
	35-40			19.8						
	40-45	14.8								
	45-50			23.3						
	50-55	22.7							17	
55-60			8.14						7.1	
Cobalt	05-10	17.6		2.32						
	10-15				2.46					
	15-20			2.23						
	20-25			1.45						
	30-35	2.5			2.19					
	35-40			1.82						
	40-45	3.97								
	45-50			10						
	50-55	8.65								
	55-60			4.55						
Iron	01-05					6880		7950		
	05-10	11100		10100		23700	40100	9740		
	10-15				8230	6880	4490	8400		
	15-20			8200		7690	3750	8690		
	20-25			8550						24000
	25-30								55000	
	30-35	15800			16100					
	35-40			5200						
	40-45	20000								
	45-50			27600						
	50-55	23800							27000	
55-60			9420						7300	

**Table 4.7. Burial Cell 2 Sample Locations and Depths of the Contaminants  
Detected above Screening Levels in SWMU 4 for Soil 1–60 ft bgs (Continued)**

Analysis	ft bgs	Historical Soil Sampling Locations				Phase 2 Soil Sampling Locations			Phase 3 Soil Sampling Locations	
		004-025	004-031	004-032	004-039	004-004P2	004-005P2	004-013P2	004-018P3	004-023P3
Manganese	01-05					277		19.5		
	05-10	1060		26.1		192	326	115		
	10-15				42.6	55.2	40.3	226		
	15-20			52.8		52	99.5	112		
	20-25			14.9						130
	25-30								89	
	30-35	94.5			48.4					
	35-40			12.9						
	40-45	72								
	45-50			97.3						
	50-55	218							160	
55-60			168						120	
Mercury	01-05					0.116		0.032		
	05-10	ND		ND		0.301	1.37	0.032		
	10-15				ND	0.023	0.045	0.023		
	15-20			ND		ND	0.019	ND		
	20-25			ND						
	30-35	ND			ND					
	35-40			ND						
	40-45	ND								
	45-50			ND						
	50-55	ND								
	55-60			ND						
Nickel	01-05					14.8		7.68		
	05-10	36		6.46		89.4	674	16.9		
	10-15				9.38	7.19	9.23	8.08		
	15-20			6.88		3.64	6.04	3.12		
	20-25			ND						5.5
	25-30								7.1	
	30-35	ND			ND					
	35-40			ND						
	40-45	5.57								
	45-50			ND						
	50-55	17.7							16	
55-60			5.27						3.8	
Silver	01-05					ND		ND		
	05-10	ND		ND		ND	ND	ND		
	10-15				ND	ND	ND	ND		
	15-20			ND		ND	ND	ND		
	20-25			ND						0.0088
	25-30								0.021	
	30-35	ND			ND					
	35-40			ND						
	40-45	ND								
	45-50			ND						
	50-55	ND							0.0065	
55-60			ND						0.0076	
Uranium	01-05					185		7.26		
	05-10					11100	1080	24.2		
	10-15					2.45	10.5	1.16		
	15-20					2.88	3.06	ND		
	20-25									0.79
	25-30								1.5	
	50-55								4.4	
	55-60									1.4

**Table 4.7. Burial Cell 2 Sample Locations and Depths of the Contaminants  
Detected above Screening Levels in SWMU 4 for Soil 1–60 ft bgs (Continued)**

Analysis	ft bgs	Historical Soil Sampling Locations				Phase 2 Soil Sampling Locations			Phase 3 Soil Sampling Locations	
		004-025	004-031	004-032	004-039	004-004P2	004-005P2	004-013P2	004-018P3	004-023P3
<i>PCBs (mg/kg)</i>										
PCB, Total	01-05					2.09		0.16		
	05-10	0.5		ND	0.908	10.5	6.8	ND		
	10-15				ND	ND	ND	ND		
	15-20			ND		ND	ND	ND		
	20-25			ND						ND
	25-30								ND	
	30-35	ND			ND					
	35-40			ND						
	40-45	ND								
	45-50			ND						
	50-55	ND							ND	
55-60			ND						ND	
<i>VOAs (mg/kg)</i>										
1,2-Dimethylbenzene	01-05					ND		ND		
	05-10	ND		ND		ND	ND	ND		
	10-15					ND	ND	ND		
	15-20			ND		ND	ND	ND		
	20-25	ND		ND						ND
	25-30								ND	
	30-35	ND								ND
	35-40			ND					ND	
	40-45	ND							ND	
	45-50			ND						ND
	50-55	ND							ND	
55-60	ND		ND						ND	
Benzene	01-05					ND		ND		
	05-10	ND		ND		ND	ND	ND		
	10-15					ND	ND	ND		
	15-20			ND		ND	ND	ND		
	20-25	ND		ND						ND
	25-30								ND	
	30-35	ND								ND
	35-40			ND					ND	
	40-45	ND							ND	
	45-50			ND						ND
	50-55	ND							ND	
55-60	ND		ND						ND	
Carbon tetrachloride	01-05					ND		ND		
	05-10	ND		ND		ND	ND	ND		
	10-15					ND	ND	ND		
	15-20			ND		ND	ND	ND		
	20-25	ND		ND						ND
	25-30								ND	
	30-35	ND								ND
	35-40			ND					ND	
	40-45	ND							ND	
	45-50			ND						ND
	50-55	ND							ND	
55-60	ND		ND						ND	

**Table 4.7. Burial Cell 2 Sample Locations and Depths of the Contaminants  
Detected above Screening Levels in SWMU 4 for Soil 1–60 ft bgs (Continued)**

Analysis	ft bgs	Historical Soil Sampling Locations				Phase 2 Soil Sampling Locations			Phase 3 Soil Sampling Locations	
		004-025	004-031	004-032	004-039	004-004P2	004-005P2	004-013P2	004-018P3	004-023P3
Chloroform	01-05					ND		ND		
	05-10	ND		ND		ND	ND	ND		
	10-15					ND	ND	ND		
	15-20			ND		ND	ND	ND		
	20-25	ND		ND						ND
	25-30								ND	
	30-35	ND								ND
	35-40			ND					ND	
	40-45	ND							ND	
	45-50			ND						ND
	50-55	ND							ND	
55-60	ND		ND						ND	
<i>cis</i> -1,2-DCE	01-05					ND		ND		
	05-10	ND		ND	ND	ND	ND	ND		
	10-15				ND	ND	ND	ND		
	15-20			ND		ND	ND	ND		
	20-25	ND		ND	ND					ND
	25-30								ND	
	30-35	ND			ND					ND
	35-40			ND					ND	
	40-45	ND							ND	
	45-50			ND						ND
	50-55	ND							ND	
55-60	ND		ND						ND	
TCE	01-05					ND		ND		
	05-10	ND		ND	ND	ND	ND	ND		
	10-15				ND	ND	ND	ND		
	15-20			ND		ND	ND	ND		
	20-25	ND		ND	ND					ND
	25-30								ND	
	30-35	ND			ND					ND
	35-40			ND					ND	
	40-45	ND							ND	
	45-50			ND						ND
	50-55	ND							ND	
55-60	ND		ND						ND	
Vinyl chloride	01-05					ND		ND		
	05-10	ND		ND	ND	ND	ND	ND		
	10-15				ND	ND	ND	ND		
	15-20			ND		ND	ND	ND		
	20-25	ND		ND	ND					ND
	25-30								ND	
	30-35	ND			ND					ND
	35-40			ND					ND	
	40-45	ND							ND	
	45-50			ND						ND
	50-55	ND							ND	
55-60	ND		ND						ND	



**Table 4.7. Burial Cell 2 Sample Locations and Depths of the Contaminants  
Detected above Screening Levels in SWMU 4 for Soil 1–60 ft bgs (Continued)**

Analysis	ft bgs	Historical Soil Sampling Locations				Phase 2 Soil Sampling Locations			Phase 3 Soil Sampling Locations	
		004-025	004-031	004-032	004-039	004-004P2	004-005P2	004-013P2	004-018P3	004-023P3
<i>Radionuclides (pCi/g)</i>										
Cesium-137	01-05					0.323		0.0486		
	05-10			ND	ND	3.61		0.521		
	10-15				ND	ND	ND	ND		
	15-20			ND		ND	ND	ND		
	20-25			ND	ND					ND
	25-30								ND	
	30-35				ND					
	45-50			ND						
	50-55								ND	
	55-60			ND						ND
Neptunium-237	01-05		ND			ND		0.493		
	05-10	ND				ND		ND		
	10-15					0.133	0.0764	ND		
	15-20					4.35	0.571	ND		
	20-25	ND								ND
	25-30								ND	
	30-35	ND								
	40-45	ND								
	50-55	ND							ND	
	55-60	ND								ND
Plutonium-239/240	01-05		ND			ND		0.221		
	05-10	ND				ND		ND		
	10-15					0.0273	0.519	ND		
	15-20					1.2	0.969	ND		
	20-25	ND								ND
	25-30								ND	
	30-35	ND								
	40-45	ND								
	50-55	ND							ND	
	55-60	ND								ND
Technetium-99	01-05		ND			4.13		1.09		
	05-10	ND		ND	ND	35.2		2.26		
	10-15				ND	ND	0.782	ND		
	15-20			ND		ND	ND	ND		
	20-25	ND		ND	ND					ND
	25-30								ND	
	30-35	ND			ND					
	35-40			ND						
	40-45	ND								
	45-50			ND						
	50-55	ND							ND	
	55-60	ND		ND						ND

**Table 4.7. Burial Cell 2 Sample Locations and Depths of the Contaminants  
Detected above Screening Levels in SWMU 4 for Soil 1–60 ft bgs (Continued)**

Analysis	ft bgs	Historical Soil Sampling Locations				Phase 2 Soil Sampling Locations			Phase 3 Soil Sampling Locations	
		004-025	004-031	004-032	004-039	004-004P2	004-005P2	004-013P2	004-018P3	004-023P3
Thorium-230	01-05					4.97		1.25		
	05-10					9.62		1.98		
	10-15					1.09	0.983	1.01		
	15-20					0.811	0.841	0.781		
	20-25									0.72
	25-30								1.07	
	50-55								1.32	
	55-60									0.928
Uranium-234	01-05		8.2			4.44		2.68		
	05-10	3.06				423		6.33		
	10-15					0.917	2.51	0.695		
	15-20					0.875	0.912	0.352		
	20-25	ND								0.572
	25-30								0.795	
	30-35	ND								
	40-45	ND								
	50-55	ND							1.28	
55-60	ND								0.479	
Uranium-235	01-05					0.297		0.15		
	05-10			ND	ND	33.3		0.374		
	10-15				ND	0.05	0.132	0.0407		
	15-20			ND		0.0543	0.0588	ND		
	20-25			ND	ND					0.0354
	25-30								0.083	
	30-35				ND					
	45-50			ND						
	50-55								0.0979	
55-60			ND						ND	
Uranium-238	01-05		36.3			15.2		4.97		
	05-10	5.41				1940		9.21		
	10-15					2.14	3.19	0.871		
	15-20					2.09	1.12	0.486		
	20-25	ND								0.633
	25-30								0.895	
	30-35	ND								
	40-45	ND								
	50-55	ND							1.77	
	55-60	ND								0.525

Blank cells indicate interval was not sampled for the specified analysis.

Maximum value shown for each depth interval.

"ND" indicates result was not detected.

Cell color coding:

Green indicates result is greater than excavation worker NAL (not greater than background).

Orange indicates result is greater than background value (not greater than excavation worker NAL).

Brown indicates result is greater than both excavation worker NAL and background values.

Red indicates result is greater than excavation worker AL and background values.

Blue indicates result is greater than RGA SSL.

(NOTE: Cell is color coded for exceeding RGA SSL only if result does not exceed NAL or background value.)

**Table 4.8. Burial Cell 3 Sample Locations and Depths of the Contaminants  
Detected above Screening Levels in SWMU 4 for Soil 1–60 ft bgs**

Color coding described in table end notes.

Analysis	ft bgs	Historical Soil Sampling Locations			Phase 2 Soil Sampling Locations		Phase 3 Soil Sampling Locations	
		004- 020	004- 044	004- 045	004- 010P2	004- 014P2	004- 017P3	004- 026P3
<i>Metals (mg/kg)</i>								
Arsenic	01-05				7.25			
	05-10		8.24	9.22	5.96	8.74		
	10-15		ND	ND	1.44	ND		
	15-20				20.3	3.55		
	20-25	ND		ND			3.6	
	25-30			5.56				6.2
	40-45	ND						
	50-55	ND					1.1	2.6
Chromium	01-05				14.1			
	05-10		19.9	14.5	39	17.5		
	10-15		20.5	16	9.15	6.78		
	15-20				54.3	8.48		
	20-25	8.97		11.4			21	
	25-30			14				19
	40-45	7.9						
	50-55	4.84					6.4	5
Cobalt	05-10		6.65	2.98				
	10-15		4.81	3				
	20-25	31.6		2.29				
	25-30			12.5				
	40-45	5.62						
	50-55	2.01						
Iron	01-05				15400			
	05-10		19800	15000	34600	19400		
	10-15		8520	12600	7460	5660		
	15-20				37100	6040		
	20-25	15500		5010			14000	
	25-30			25200				30000
	40-45	8960						
	50-55	16500					12000	10000
Manganese	01-05				3260			
	05-10		1200	264	621	917		
	10-15		289	81	166	65.9		
	15-20				525	81.4		
	20-25	199		84.2			98	
	25-30			278				35
	40-45	129						
	50-55	49.8					250	30
Mercury	01-05				0.023			
	05-10		ND	ND	0.181	0.027		
	10-15		ND	ND	0.047	ND		
	15-20				ND	ND		
	20-25	ND		ND				
	25-30			ND				
	40-45	ND						
	50-55	ND						

**Table 4.8. Burial Cell 3 Sample Locations and Depths of the Contaminants Detected above Screening Levels in SWMU 4 for Soil 1–60 ft bgs (Continued)**

Analysis	ft bgs	Historical Soil Sampling Locations			Phase 2 Soil Sampling Locations		Phase 3 Soil Sampling Locations	
		004-020	004-044	004-045	004-010P2	004-014P2	004-017P3	004-026P3
Nickel	01-05				39.2			
	05-10		53	33.3	1870	19.3		
	10-15		7.26	8.37	7.06	5.02		
	15-20				12.8	3.69		
	20-25	6.83		ND			4.9	
	25-30			46.2				16
	40-45	ND						
	50-55	6.39					5.5	3.6
Silver	01-05				ND			
	05-10		ND	ND	ND	ND		
	10-15		ND	ND	ND	ND		
	15-20				ND	ND		
	20-25	ND		ND			0.014	
	25-30			ND				0.0073
	40-45	ND						
	50-55	ND					0.008	ND
Uranium	01-05				50.7			
	05-10				880	36		
	10-15				6.69	ND		
	15-20				1.72	ND		
	20-25						0.94	
	25-30							31
	50-55						0.7	1.7
	<i>PCBs (mg/kg)</i>							
PCB, Total	01-05				0.21			
	05-10		ND	ND	2.13	0.17		
	10-15		ND	ND	ND	ND		
	15-20				ND	ND		
	20-25	ND		ND			ND	
	25-30			ND				0.087
	40-45	ND						
	50-55	ND					ND	0.079
<i>VOAs (mg/kg)</i>								
1,2-Dimethylbenzene	01-05				ND			
	05-10				ND	ND		
	10-15				ND	ND		
	15-20				ND	ND		
	20-25	ND					ND	
	25-30							ND
	30-35						ND	
	35-40							ND
	40-45	ND						ND
	45-50						ND	
	50-55	ND					ND	ND
55-60	ND							

**Table 4.8. Burial Cell 3 Sample Locations and Depths of the Contaminants Detected above Screening Levels in SWMU 4 for Soil 1–60 ft bgs (Continued)**

Analysis	ft bgs	Historical Soil Sampling Locations			Phase 2 Soil Sampling Locations		Phase 3 Soil Sampling Locations	
		004-020	004-044	004-045	004-010P2	004-014P2	004-017P3	004-026P3
Benzene	01-05				ND			
	05-10				ND	ND		
	10-15				ND	ND		
	15-20				ND	ND		
	20-25	ND					ND	
	25-30							ND
	30-35						ND	
	35-40							ND
	40-45	ND						ND
	45-50						ND	
	50-55	ND					ND	ND
	55-60	ND						
Carbon tetrachloride	01-05				ND			
	05-10				ND	ND		
	10-15				ND	ND		
	15-20				ND	ND		
	20-25	ND					ND	
	25-30							ND
	30-35						ND	
	35-40							ND
	40-45	ND						ND
	45-50						ND	
	50-55	ND					ND	ND
	55-60	ND						
Chloroform	01-05				ND			
	05-10				ND	ND		
	10-15				ND	ND		
	15-20				ND	ND		
	20-25	ND					ND	
	25-30							ND
	30-35						ND	
	35-40							ND
	40-45	ND						ND
	45-50						ND	
	50-55	ND					ND	ND
	55-60	ND						
<i>cis</i> -1,2-DCE	01-05				ND			
	05-10		ND	ND	ND	ND		
	10-15		ND	ND	ND	ND		
	15-20				ND	ND		
	20-25	ND	ND	ND			ND	
	25-30			ND				ND
	30-35		ND				ND	
	35-40							ND
	40-45	ND						0.024
	45-50						0.0065	
	50-55	ND					0.0095	0.011
	55-60	ND						

**Table 4.8. Burial Cell 3 Sample Locations and Depths of the Contaminants Detected above Screening Levels in SWMU 4 for Soil 1–60 ft bgs (Continued)**

Analysis	ft bgs	Historical Soil Sampling Locations			Phase 2 Soil Sampling Locations		Phase 3 Soil Sampling Locations	
		004-020	004-044	004-045	004-010P2	004-014P2	004-017P3	004-026P3
TCE	01-05				ND			
	05-10		ND	ND	ND	ND		
	10-15		ND	ND	ND	ND		
	15-20				ND	ND		
	20-25	ND	ND	ND			ND	
	25-30			ND				ND
	30-35		ND				ND	
	35-40							ND
	40-45	0.049						0.16
	45-50						0.068	
	50-55	0.038					0.1	0.1
55-60	0.033							
Vinyl chloride	01-05				ND			
	05-10		ND	ND	ND	ND		
	10-15		ND	ND	ND	ND		
	15-20				ND	ND		
	20-25	ND	ND	ND			ND	
	25-30			ND				ND
	30-35		ND				ND	
	35-40							ND
	40-45	ND						ND
	45-50						ND	
	50-55	ND					ND	ND
55-60	ND							
<i>Radionuclides (pCi/g)</i>								
Cesium-137	01-05				0.0589			
	05-10		ND	ND	2.91	ND		
	10-15		ND	ND	ND	ND		
	15-20				ND	ND		
	20-25	ND	ND	ND			ND	
	25-30			ND				ND
	30-35		ND					
	40-45	ND						
	50-55	ND					ND	ND
55-60	ND							
Neptunium-237	01-05	ND			0.13			
	05-10				49.3	ND		
	10-15				ND	ND		
	15-20				ND	ND		
	20-25						ND	
	25-30							0.184
	50-55						ND	ND
Plutonium-239/240	01-05	ND			ND			
	05-10				7.38	ND		
	10-15				ND	ND		
	15-20				ND	ND		
	20-25						ND	
	25-30							ND
	50-55						ND	ND

**Table 4.8. Burial Cell 3 Sample Locations and Depths of the Contaminants Detected above Screening Levels in SWMU 4 for Soil 1–60 ft bgs (Continued)**

Analysis	ft bgs	Historical Soil Sampling Locations			Phase 2 Soil Sampling Locations		Phase 3 Soil Sampling Locations	
		004-020	004-044	004-045	004-010P2	004-014P2	004-017P3	004-026P3
Technetium-99	01-05				ND			
	05-10		ND	ND	207	ND		
	10-15		ND	ND	1.68	ND		
	15-20				ND	ND		
	20-25	ND		ND			ND	
	25-30			ND				ND
	30-35	ND						
	40-45	ND						
	50-55	ND					ND	ND
55-60	ND							
Thorium-230	01-05				1.57			
	05-10				27	0.979		
	10-15				0.799	0.981		
	15-20				0.829	0.694		
	20-25						0.414	
	25-30							1.56
	50-55						0.617	0.669
Uranium-234	01-05	2.68			8.25			
	05-10				54.2	1.52		
	10-15				0.941	0.38		
	15-20				0.607	0.531		
	20-25						0.512	
	25-30							7.22
	50-55						0.677	1.1
Uranium-235	01-05				0.529			
	05-10		ND	ND	3.18	0.125		
	10-15		ND	ND	0.0616	0.0272		
	15-20				0.0387	ND		
	20-25	ND	ND	ND			0.0234	
	25-30			ND				0.63
	30-35		ND					
	40-45	ND						
	50-55	ND					0.0622	0.0727
55-60	ND							
Uranium-238	01-05	3.84			15.7			
	05-10				96.8	7.92		
	10-15				1.45	0.442		
	15-20				0.684	0.627		
	20-25						0.401	
	25-30							23.4
	50-55						0.724	2.91

Blank cells indicate interval was not sampled for the specified analysis.

Maximum value shown for each depth interval.

"ND" indicates result was not detected.

Cell color coding:

Green indicates result is greater than excavation worker NAL (not greater than background).

Orange indicates result is greater than background value (not greater than excavation worker NAL).

Brown indicates result is greater than both excavation worker NAL and background values.

Blue indicates result is greater than RGA SSL.

(NOTE: Cell is color coded for exceeding RGA SSL only if result does not exceed NAL or background value.)

**THIS PAGE INTENTIONALLY LEFT BLANK**



Table 4.9. Burial Cell 4 Sample Locations and Depths of the Contaminants Detected above Screening Levels in SWMU 4 for Soil 1–60 ft bgs

Color coding described in table end notes.

Analysis	ft bgs	Historical Soil Sampling Locations														Phase 2 Soil Sampling Locations										Phase 3 Soil Sampling Locations														
		004-009	004-011	004-022	004-024	004-026	004-027	004-030	004-033	004-034	004-036	004-046	004-049	004-050	004-052	004-057	004-001P2	004-009P2	004-011P2	004-012P2	004-015P2	004-016P2	004-017P2	004-018P2	004-020P2	004-001P3	004-002P3	004-006P3	004-007P3	004-008P3	004-009P3	004-012P3	004-014P3	004-015P3	004-019P3	004-020P3	004-021P3	004-024P3		
<i>Metals (mg/kg)</i>																																								
Arsenic	01-05									17.1								4.95			22.8	4.97																		
	05-10	ND		ND	ND	ND			ND	ND	ND	9.45		ND			6.61	2.15	6.49	6.54	2.09	1.23	1.63	9.37	9.15															
	10-15		ND								ND	ND	ND				5.57	ND	4.09	13.4	4.65	5.14	ND	4.67	1.71															
	15-20	ND	ND						ND	ND							1.17	1.38	1.75	1.48	ND	ND	ND	1.22	1.88															
	20-25	ND		ND		ND					ND		ND		ND													5.74		17.4				3.7						10
	25-30																									2.35		4.83		6.91	7.83	19		4.7	7.5	8.6	11			
	30-35			ND	ND	ND	ND																																	
	35-40	ND																																						
	40-45			ND	ND	ND	5.16																																	
	45-50							ND																																
	50-55			ND	ND		ND								ND											16.1	3.2	7.62	ND	3.34	1.16	0.82	3.1	1.6	1.9	3.1			4.6	
55-60				ND	ND																																	0.78		
Chromium	01-05										15.3							10			18.9	19.1																		
	05-10	8.92		16.5	14.7	13.8			12.2	9.66	19.1	8.48		11		20.2	8.66	46.5	82.7	105	12.3	8.36	98.6	136																
	10-15		11.1								14.5	12.2	10.5			17.2	12.2	8.89	393	18.1	12.9	14	9.61	10.3																
	15-20	12.3	7.86						10.5	13.9						8.99	16.8	3.31	7.98	10.1	5.63	9.08	6	6.57																
	20-25	8.77		9.64		14.5					8.06		25.4	17.8													23.6		62				45					80		
	25-30																								13.8		29.5		46.3	8.68	26		43	20	46	51				
	30-35			10.9	7.76	10.3	8.99																																	
	35-40	4.55																																						
	40-45			10.1	8.21	14.8	12.6							13																										
	45-50							11.1																																
	50-55			9.66	5.15		9.33								8.31											8.3	4.51	23.2	4.93	6.98	5.27	6.5	8.7	6.9	5.8	9.9		5.6		
55-60				3.64		5.49																															5.2			
Cobalt	01-05										8.46																													
	05-10	3.47		3.1	3.29	6.39			5.22	3.75	5.81	7.14		7.85																										
	10-15		4.54								4.96	4.4	2.13																											
	15-20	4.12	4.88						10.1	2.03																														
	20-25	3.24		ND		3.83					6.29		7.91	2.97																										
	30-35			4.49	2.85	2.25	4.97																																	
	35-40	2.15																																						
	40-45			2.61	3.19	4.24	4.29							1.75																										
	45-50							6.08																																
50-55			2.89	4.92		3.14							3.42																											
55-60				1.01		ND																																		
Iron	01-05										21000						10500			24300	13300																			
	05-10	6540		7880	12400	15100			22800	9260	22300	14600		13300		34300	7730	21600	36200	8490	10700	6610	44100	30400																
	10-15		16000								9330	7390	6320			11500	7440	15100	24800	15200	18700	9380	11500	10400																
	15-20	9250	7870						10100	6890						7540	11700	7250	7790	9270	3220	5260	4560	6900																
	20-25	8980		4880		10600					9300		11900	5510													32000		46600				19000					65000		
	25-30																								10200		22600		26700	15900	28000		16000	24000	34000	31000				
	30-35			11800	9570	14000	9600																																	
	35-40	10300																																						
	40-45			5990	22900	19100	23500							8210																										
	45-50							33400																																
	50-55			11700	10200		12700							17100												33700	14400	87700	9960	20600	7990	9600	20000	11000	13000	50000		17000		
55-60				4020		7280																															10000			

Table 4.9. Burial Cell 4 Sample Locations and Depths of the Contaminants Detected above Screening Levels in SWMU 4 for Soil 1–60 ft bgs (Continued)

Analysis	ft bgs	Historical Soil Sampling Locations														Phase 2 Soil Sampling Locations										Phase 3 Soil Sampling Locations														
		004-009	004-011	004-022	004-024	004-026	004-027	004-030	004-033	004-034	004-036	004-046	004-049	004-050	004-052	004-057	004-001P2	004-009P2	004-011P2	004-012P2	004-015P2	004-016P2	004-017P2	004-018P2	004-020P2	004-001P3	004-002P3	004-006P3	004-007P3	004-008P3	004-009P3	004-012P3	004-014P3	004-015P3	004-019P3	004-020P3	004-021P3	004-024P3		
Manganese	01-05									1140								7530			1170	334																		
	05-10	330		58.9	90.8	357			308	521	458	510		267			117	64.7	525	499	44.7	28.2	46.2	899	676															
	10-15		346							347	280	45.4					302	53.6	501	919	129	184	57.5	163	212															
	15-20	2700	731						590	28.5							50.6	205	229	159	160	28	196	128	297															
	20-25	123		19.6		38.1					232		101		197													373		135			340						760	
	25-30																									51.5		362		361	69.3	100		130	150	280	160			
	30-35			69.6	34.8	60.8	360																																	
	35-40	84.6																																						
	40-45			164	260	182	124								74.2																									
	45-50							93.8																																
50-55			162	188		168								101												255	121	8490	127	351	192	28	97	250	57	270		90		
55-60				38		37.8																																	57	
Mercury	01-05										ND							0.02			0.027	0.075																		
	05-10	ND		ND	ND	ND			ND	ND	ND	ND		ND			0.032	ND	1.44	0.457	ND	ND	ND	2.58	0.105															
	10-15		ND								ND	ND	ND				0.035	ND	3.53	0.466	ND	ND	0.023	0.022	0.023															
	15-20	ND	ND						ND	ND							ND	ND	ND	ND	ND	ND	0.048	ND	0.021															
	20-25	ND		ND		ND					ND		ND		ND																									
	30-35			ND	ND	ND	ND																																	
	35-40	ND																																						
	40-45			ND	ND	ND	ND								ND																									
	45-50							ND																																
	50-55			ND	ND		ND								ND																									
55-60				ND		ND																																		
Nickel	01-05										7.52							10.1			29.2	40.6																		
	05-10	6.1		10.3	8.8	8.79			ND	ND	9.68	9.67		9.56			23.8	7.04	3230	63.8	227	11.1	8.09	728	2160															
	10-15		5.11								8.42	21.1	7.26				50.4	9.43	22.2	657	20.3	14.2	10.6	11.4	7.94															
	15-20	5.78	7.17						ND	6.76							7.12	8.68	3.46	5.21	7.67	3.34	5.91	2.83	4.77															
	20-25	ND		ND		ND					ND		ND		ND													7.03		18.9				7.4					11	
	25-30																										4.61		7.05		20.4	7.65	6.8		7.1	7.9	7.2	19		
	30-35			8.09	ND	ND	ND																																	
	35-40	ND																																						
	40-45			5.57	5.79	ND	7.28								19.1																									
	45-50							13.2																																
50-55			6.92	ND		5.33								ND												9.16	5.06	21.1	4.37	10.6	3.47	4.4	8	5.4	3.8	9.1		5.8		
55-60				ND		ND																																3.3		
Silver	01-05									ND							ND			ND	ND																			
	05-10	ND		ND	ND	ND			ND	ND	ND	ND		ND			ND	ND	ND	1.93	18.9	ND	ND	2.48	8.83															
	10-15		ND							ND	ND	ND					ND	ND	ND	1.49	ND	ND	ND	ND	ND															
	15-20	ND	ND						ND	ND							ND	ND	ND	ND	ND	ND	ND	ND	ND															
	20-25	ND		ND		ND					ND		ND		ND														ND		ND						0.024			0.016
	25-30																										ND		ND		ND	ND	0.011		0.022	0.019	0.015	0.013		
	30-35			ND	ND	ND	ND																																	
	35-40	ND																																						
	40-45			ND	ND	ND	ND								ND																									
	45-50							ND																																
50-55			ND	ND		ND								ND												ND	ND	ND	ND	ND	ND	ND	ND	ND	ND	0.0028	0.0049	0.0054		ND
55-60				ND		ND																																0.0031		





Table 4.9. Burial Cell 4 Sample Locations and Depths of the Contaminants Detected above Screening Levels in SWMU 4 for Soil 1–60 ft bgs (Continued)

Analysis	ft bgs	Historical Soil Sampling Locations														Phase 2 Soil Sampling Locations										Phase 3 Soil Sampling Locations															
		004-009	004-011	004-022	004-024	004-026	004-027	004-030	004-033	004-034	004-036	004-046	004-049	004-050	004-052	004-057	004-001P2	004-009P2	004-011P2	004-012P2	004-015P2	004-016P2	004-017P2	004-018P2	004-020P2	004-001P3	004-002P3	004-006P3	004-007P3	004-008P3	004-009P3	004-012P3	004-014P3	004-015P3	004-019P3	004-020P3	004-021P3	004-024P3			
TCE	01-05									ND					ND			ND		ND	ND																				
	05-10	ND		ND	0.016	0.0036	ND		0.004	ND	ND		ND	ND		ND	ND	ND	ND	ND	ND	ND	ND	ND																	
	10-15		ND								ND	ND	ND	ND		ND	ND	ND	ND	ND	ND	ND	ND	ND					0.0163	ND											
	15-20	ND	ND					0.079	ND							ND	ND	ND	ND	ND	ND	ND	ND	ND					0.0488	ND											
	20-25	ND		ND		0.0072		ND	ND	0.053	ND	ND	ND		ND	ND										0.0442		4.59				ND							0.08		
	25-30																								0.097		0.0755		0.396	1.13	ND		0.092	750	ND	ND					
	30-35			41	4.4	0.2	0.049																				2.38				0.0083		0.15			ND	4.5				
	35-40	0.77																								0.0571		0.0083	45.4	0.794	6.04		ND		23	ND					
	40-45			4.9	8.5	0.012	0.113								ND											ND	0.466	1.94		0.288		0.0078	0.019		25		0.0034				
	45-50							9.2																						5.96		8			0.096		0.22		12		
	50-55			6	7	0.12	2.86								ND											ND	0.0681	2.49	6.29	ND	12.4	0.075	0.036	0.11	5.5	0.59			11		
55-60			1.1	2.1		13	25																														1.1				
Vinyl chloride	01-05									ND					ND			ND	ND																						
	05-10	ND		ND	ND	ND	ND		ND	ND	ND		ND	ND		ND	ND	ND	ND	ND	ND	ND	ND	ND																	
	10-15		ND								ND	ND	ND	ND		ND	ND	ND	ND	ND	ND	ND	ND	ND					ND	ND											
	15-20	0.051	ND						ND	ND						ND	ND	ND	ND	ND	0.164	0.0066	0.0267	ND					ND	0.0017											
	20-25	ND		ND		ND		ND	ND	ND	ND	ND		ND	ND												ND		0.0048				ND						0.061		
	25-30																								0.0368		ND		0.0067	0.0167	ND		0.0056	0.59	0.009	ND					
	30-35			0.22	ND	ND	ND																				0.004				0.007		0.019				ND	0.2			
	35-40	0.29																								ND		0.0011	2.8	0.0394	0.468		ND		ND	ND					
	40-45			0.018	ND	ND	ND								ND											ND	ND	0.0064		0.0081		ND	ND		0.092		0.0051				
	45-50							ND																					0.607		ND			0.0046		0.13			0.069		
	50-55			0.011	ND	ND	ND								ND											ND	ND	0.0092	0.691	0.0843	0.111	ND	ND	0.0028	0.024	0.06			0.31		
55-60			ND	ND		ND	0.24																															0.0073			
<i>Radionuclides (pCi/g)</i>																																									
Cesium-137	01-05									ND					ND			0.0496			ND	0.114																			
	05-10	ND			ND			1.48	ND	ND	ND		ND	ND		ND	ND	0.155	0.401	0.0661	ND	ND	2.38	0.442																	
	10-15		ND								ND	ND	ND	ND		ND	0.0664	ND	0.0591		ND	ND	ND	ND	0.115																
	15-20	ND	ND								ND	ND				ND	ND	ND	ND	ND	ND	ND	ND	ND																	
	20-25	ND									ND	ND	ND	ND	ND												ND		ND											ND	
	25-30																									ND		ND		ND	ND	ND		ND	0.0628	ND	0.185				
	30-35				ND																																				
	35-40	ND																																							
	40-45				ND										ND																										
	45-50							ND																																	
	50-55				ND										ND												ND	ND	ND	ND	ND	ND	ND	ND	ND	ND	ND	ND	ND	ND	ND
55-60				ND			ND																																ND		

Table 4.9. Burial Cell 4 Sample Locations and Depths of the Contaminants Detected above Screening Levels in SWMU 4 for Soil 1–60 ft bgs (Continued)

Analysis	ft bgs	Historical Soil Sampling Locations														Phase 2 Soil Sampling Locations								Phase 3 Soil Sampling Locations																								
		004-009	004-011	004-022	004-024	004-026	004-027	004-030	004-033	004-034	004-036	004-046	004-049	004-050	004-052	004-057	004-001P2	004-009P2	004-011P2	004-012P2	004-015P2	004-016P2	004-017P2	004-018P2	004-020P2	004-001P3	004-002P3	004-006P3	004-007P3	004-008P3	004-009P3	004-012P3	004-014P3	004-015P3	004-019P3	004-020P3	004-021P3	004-024P3										
Neptunium-237	01-05																	ND			ND	0.339																										
	05-10	1.58		ND		ND			0.112			1.84						0.342	ND	0.46	1.05	ND	ND	ND	100	1.86																						
	10-15																0.053	ND	0.628		ND	ND	ND	ND	ND																							
	15-20																ND	ND	0.153	ND	ND	ND	ND	ND	ND																							
	20-25			ND		ND																					ND			0.119					ND									ND				
	25-30																									ND		ND			ND	ND	ND				0.16	ND	ND	ND								
	30-35			ND		ND	ND																																									
	40-45			ND		ND	ND																																									
	50-55			ND		ND	ND																				ND	ND	ND	ND	ND	ND	ND	ND	ND	ND	ND	ND	ND	ND	ND	ND	ND	ND	0.101			
55-60						ND																																					ND					
Plutonium-239/240	01-05																		ND			ND	0.159																									
	05-10	0.0929		ND		ND		4.17	ND			0.354						0.0777	ND	0.094	0.57	ND	ND	ND	71.1	0.929																						
	10-15																	ND	ND	0.0749		ND	ND	ND	ND	ND																						
	15-20																	ND	ND	ND	ND	ND	ND	ND	ND	ND																						
	20-25			ND		ND																						ND		ND																		ND
	25-30																									ND		ND			ND	ND	ND					0.0424	ND	ND	0.0265							
	30-35			ND		ND	ND																																									
	40-45			ND		ND	ND																																									
	50-55			ND		ND	ND																				ND	ND	ND	ND	ND	ND	ND	ND	ND	ND	ND	ND	ND	ND	ND	ND	ND	ND	ND	ND	ND	
55-60						ND																																							ND			
Technetium-99	01-05										6.37				ND			1.21			ND	7.22																										
	05-10	9.01	77.3	ND	ND	ND	ND	269	10.4	ND	ND	14.6		ND	ND	4.22	ND	865	36.7	ND	ND	ND	1050	39.7																								
	10-15		ND								ND	ND	ND	ND	ND	7.21	ND	4.58		ND	ND	ND	5.88	9.49																								
	15-20	ND	ND						ND	ND							ND	ND	ND	ND	ND	ND	ND	ND	ND																							
	20-25			ND		ND		ND			ND	ND	ND		ND	ND											0.824			6.32				ND														ND
	25-30																									ND		ND			ND	ND	ND					ND	22	ND	ND							
	30-35			ND	ND	ND	ND																																									
	35-40	ND																																														
	40-45			ND	ND	ND	ND								ND																																	
	45-50							ND																																								
50-55			ND	ND	ND	ND								ND												2.67	ND	ND	ND	ND	ND	ND	ND	ND	ND	ND	ND	ND	ND	ND	ND	ND	ND	ND	ND	ND		
55-60			ND	ND		ND	ND																																							ND		
Thorium-230	01-05																	0.95				1.05	2.56																									
	05-10								68.7									2.48	1.11	2.12	8.85	1.35	1.13	0.841	727	14.2																						
	10-15																0.848	0.953	1.4		1.06	0.985	1.01	1.34	0.969																							
	15-20																0.836	0.519	1.15	0.814	0.753	0.676	0.913	0.834	0.498																							
	20-25																												0.751		1.39					0.644												0.843
	25-30																										0.709		0.721		0.471	0.4	0.72		0.691	0.863	0.848	0.73										
	50-55																										0.852	0.674	0.765	0.735	0.947	0.531	0.848	0.745	0.52	0.538	0.554							0.559				
	55-60																																													0.387		

Table 4.9. Burial Cell 4 Sample Locations and Depths of the Contaminants Detected above Screening Levels in SWMU 4 for Soil 1–60 ft bgs (Continued)

Analysis	ft bgs	Historical Soil Sampling Locations														Phase 2 Soil Sampling Locations								Phase 3 Soil Sampling Locations																										
		004-009	004-011	004-022	004-024	004-026	004-027	004-030	004-033	004-034	004-036	004-046	004-049	004-050	004-052	004-057	004-001P2	004-009P2	004-011P2	004-012P2	004-015P2	004-016P2	004-017P2	004-018P2	004-020P2	004-001P3	004-002P3	004-006P3	004-007P3	004-008P3	004-009P3	004-012P3	004-014P3	004-015P3	004-019P3	004-020P3	004-021P3	004-024P3												
Uranium-234	01-05																	1.38			13.5	10.2																												
	05-10	7.68		ND		ND													25	0.754	9.56	287	214	0.838	0.722	779	4170																							
	10-15																		5.76	0.514	12.8		2.01	0.949	0.613	1.87	8.32																							
	15-20																		2.97	0.359	6.82	15.5	19.9	0.631	0.633	0.705	0.44																							
	20-25			ND		ND																																									0.889			
	25-30																										0.798		0.741		0.376	0.388	1.65				7.47	12.4	0.956	3.21										
	30-35			ND		ND		1.74																																										
	40-45			ND		ND	ND																																											
	50-55			ND		ND	ND																				4.47	0.499	0.525	0.739	0.733	0.39	0.743	0.64	0.851	0.491	0.656								0.471					
55-60						ND																																							0.429					
Uranium-235	01-05										ND					ND				0.0817			0.941	0.606																										
	05-10	ND			ND				ND	ND	ND		ND	ND		ND	1.49	0.0366	0.738	19.3	13	0.0539	0.0284	46.6	260																									
	10-15		ND								ND	ND	ND	ND		ND	0.254	0.0332	0.949		0.119	0.0623	0.0319	0.157	0.509																									
	15-20	ND	ND							ND	ND					ND	0.144	ND	0.496	0.789	1.34	0.0458	0.0536	0.0249	ND																									
	20-25	ND								ND	ND	ND	ND	ND		ND	ND																																0.0634	
	25-30																									0.0467			0.0305		0.0231	0.0186	0.116				0.436	0.777	0.0998	0.187										
	30-35				ND																																													
	35-40	ND																																																
	40-45					ND											ND																																	
	45-50									ND																																								
	50-55					ND											ND												0.231	0.0248	0.0255	0.0473	0.0213	0.0201	0.0418	0.0257	0.0531	0.0345	ND							0.0576				
55-60					ND			ND																																						0.0442				
Uranium-238	01-05																			2.28			23.5	18.9																										
	05-10	15.1		ND		ND															32.7	0.891	24.6	758	299	0.855	0.904	1140	6210																					
	10-15																				7.56	0.576	38.3		2.63	1.17	0.762	2.89	9.3																					
	15-20																				4.23	0.364	18.9	18.1	53.7	0.745	0.762	0.875	0.559																					
	20-25			ND		ND																																												0.95
	25-30																										1.13		0.572		0.395	0.382	1.99				15.4	13.5	1.03	4.19										
	30-35			ND		ND		0.524																																										
	40-45			ND		ND	ND																																											
	50-55			ND		ND	ND																					5.37	0.553	0.538	1.11	0.712	0.444	0.789	0.611	1.24	0.493	0.727								0.558				
55-60						ND																																									0.424			

Blank cells indicate interval was not sampled for the specified analysis.

Maximum value shown for each depth interval.

"ND" indicates result was not detected.

Cell color coding:

Green indicates result is greater than excavation worker NAL (not greater than background).

Orange indicates result is greater than background value (not greater than excavation worker NAL).

Brown indicates result is greater than both excavation worker NAL and background values.

Red indicates result is greater than excavation worker AL and background values.

Blue indicates result is greater than RGA SSL.

(NOTE: Cell is color coded for exceeding RGA SSL only if result does not exceed NAL or background value.)

**THIS PAGE INTENTIONALLY LEFT BLANK**



**Table 4.10. Burial Cell 5 Sample Locations and Depths of the Contaminants  
Detected above Screening Levels in SWMU 4 for Soil 1–60 ft bgs**

Color coding described in table end notes.

Analysis	ft bgs	Historical Soil Sampling Locations	Phase 2 Soil Sampling Locations	Phase 3 Soil Sampling Locations		
		004- 047	004- 007P2	004- 004P3	004- 011P3	004- 025P3
<i>Metals (mg/kg)</i>						
Arsenic	05-10	ND	2.75			
	10-15	ND	3.81			
	15-20		8.36			
	20-25	ND				
	25-30			4.6	4.38	0.72
	50-55			6.72	1.79	
	55-60					3.4
Chromium	05-10	17.9	9.21			
	10-15	13.9	11.4			
	15-20		11			
	20-25	9.38				
	25-30			17.3	9.38	13
	50-55			16.2	6.93	
	55-60					7.8
Cobalt	05-10	2.66				
	10-15	6.62				
	20-25	4.3				
Iron	05-10	11300	6640			
	10-15	9590	9440			
	15-20		7180			
	20-25	4660				
	25-30			13500	9910	3600
	50-55			19400	8560	
	55-60					18000
Manganese	05-10	41.6	23.7			
	10-15	81.3	65.2			
	15-20		102			
	20-25	77.9				
	25-30			23.6	99.1	17
	50-55			223	46.4	
	55-60					310
Mercury	05-10	ND	0.053			
	10-15	ND	0.039			
	15-20		ND			
	20-25	ND				
Nickel	05-10	31.5	8.84			
	10-15	33.5	18.3			
	15-20		8.29			
	20-25	31.7				
	25-30			3.86	2.81	1.4
	50-55			7.36	6.17	
	55-60					9.3
Silver	05-10	ND	ND			
	10-15	ND	ND			
	15-20		ND			
	20-25	ND				
	25-30			ND	ND	0.0051
	50-55			ND	ND	
	55-60					0.0053

**Table 4.10. Burial Cell 5 Sample Locations and Depths of the Contaminants Detected above Screening Levels in SWMU 4 for Soil 1–60 ft bgs (Continued)**

Analysis	ft bgs	Historical Soil Sampling Locations	Phase 2 Soil Sampling Locations	Phase 3 Soil Sampling Locations		
		004-047	004-007P2	004-004P3	004-011P3	004-025P3
Uranium	05-10		1.82			
	10-15		1.17			
	15-20		ND			
	25-30			ND	ND	0.34
	50-55			ND	ND	
	55-60					0.53
<i>PCBs (mg/kg)</i>						
PCB, Total	05-10	27	0.15			
	10-15	ND	ND			
	15-20		ND			
	20-25	ND				
	25-30			ND	ND	ND
	50-55			ND	ND	
	55-60					ND
<i>VOAs (mg/kg)</i>						
1,2-Dimethylbenzene	05-10		ND			
	10-15		ND		ND	
	15-20		ND		ND	
	20-25					
	25-30			ND	ND	ND
	30-35				ND	ND
	35-40			ND		
	40-45			ND		ND
	45-50				ND	
	50-55			ND	ND	
	55-60					ND
Benzene	05-10		ND			
	10-15		ND		0.000863	
	15-20		ND		ND	
	20-25					
	25-30			ND	ND	ND
	30-35				ND	ND
	35-40			ND		
	40-45			ND		ND
	45-50				ND	
	50-55			ND	ND	
55-60					ND	
Carbon tetrachloride	05-10		ND			
	10-15		ND		ND	
	15-20		ND		ND	
	20-25					
	25-30			ND	ND	ND
	30-35				ND	ND
	35-40			ND		
	40-45			ND		ND
	45-50				ND	
	50-55			ND	ND	
55-60					ND	

**Table 4.10. Burial Cell 5 Sample Locations and Depths of the Contaminants Detected above Screening Levels in SWMU 4 for Soil 1–60 ft bgs (Continued)**

Analysis	ft bgs	Historical Soil Sampling Locations	Phase 2 Soil Sampling Locations	Phase 3 Soil Sampling Locations		
		004-047	004-007P2	004-004P3	004-011P3	004-025P3
Chloroform	05-10		ND			
	10-15		ND		ND	
	15-20		ND		ND	
	20-25					
	25-30			ND	ND	ND
	30-35				ND	ND
	35-40			ND		
	40-45			ND		ND
	45-50				ND	
	50-55			ND	ND	
55-60					ND	
<i>cis</i> -1,2-DCE	05-10	ND	0.0806			
	10-15	ND	0.164		0.0022	
	15-20		0.151		ND	
	20-25	ND				
	25-30			0.0148	0.109	ND
	30-35				0.14	ND
	35-40			0.0219		
	40-45			0.00615		ND
	45-50				0.0976	
	50-55			0.0441	0.075	
55-60					ND	
TCE	05-10	ND	0.0814			
	10-15	ND	ND		ND	
	15-20		ND		ND	
	20-25	ND				
	25-30			0.00255	0.176	0.002
	30-35				0.0975	0.0029
	35-40			0.0129		
	40-45			0.00258		ND
	45-50				0.249	
	50-55			0.0304	0.213	
55-60					ND	
Vinyl chloride	05-10	ND	ND			
	10-15	ND	ND		0.0109	
	15-20		ND		0.00717	
	20-25	ND				
	25-30			ND	0.0414	ND
	30-35				0.06	ND
	35-40			ND		
	40-45			ND		ND
	45-50				0.00583	
	50-55			ND	0.0064	
55-60					ND	

**Table 4.10. Burial Cell 5 Sample Locations and Depths of the Contaminants Detected above Screening Levels in SWMU 4 for Soil 1–60 ft bgs (Continued)**

Analysis	ft bgs	Historical Soil Sampling Locations	Phase 2 Soil Sampling Locations	Phase 3 Soil Sampling Locations		
		004-047	004-007P2	004-004P3	004-011P3	004-025P3
<i>Radionuclides (pCi/g)</i>						
Cesium-137	05-10	ND	ND			
	10-15	ND	ND			
	15-20		ND			
	20-25	ND				
	25-30			ND	ND	ND
	50-55			ND	ND	
	55-60					ND
Neptunium-237	05-10		ND			
	10-15		ND			
	15-20		ND			
	25-30			ND	ND	ND
	50-55			ND	ND	
	55-60					0.166
Plutonium-239/240	05-10		ND			
	10-15		ND			
	15-20		ND			
	25-30			ND	ND	ND
	50-55			ND	ND	
	55-60					ND
Technetium-99	01-05	26.1				
	05-10	8.06	0.885			
	10-15	ND	ND			
	15-20		ND			
	20-25	ND				
	25-30			ND	ND	ND
	50-55			ND	0.863	
	55-60					ND
Thorium-230	05-10		1.28			
	10-15		0.874			
	15-20		0.968			
	25-30			0.332	0.361	0.684
	50-55			0.714	0.555	
	55-60					0.656
Uranium-234	05-10		0.674			
	10-15		0.559			
	15-20		0.539			
	25-30			0.282	0.267	0.427
	50-55			0.534	0.455	
	55-60					0.615
Uranium-235	05-10	ND	0.0405			
	10-15	ND	0.0363			
	15-20		0.0343			
	20-25	ND				
	25-30			ND	0.0172	ND
	50-55			0.0199	0.0285	
	55-60					ND

**Table 4.10. Burial Cell 5 Sample Locations and Depths of the Contaminants  
Detected above Screening Levels in SWMU 4 for Soil 1–60 ft bgs (Continued)**

Analysis	ft bgs	Historical Soil Sampling Locations	Phase 2 Soil Sampling Locations	Phase 3 Soil Sampling Locations		
		004- 047	004- 007P2	004- 004P3	004- 011P3	004- 025P3
Uranium-238	05-10		0.813			
	10-15		0.92			
	15-20		0.624			
	25-30			0.278	0.327	0.35
	50-55			0.5	0.407	
	55-60					0.691

Blank cells indicate interval was not sampled for the specified analysis.

Maximum value shown for each depth interval.

"ND" indicates result was not detected.

Cell color coding:

Green indicates result is greater than excavation worker NAL (not greater than background).

Orange indicates result is greater than background value (not greater than excavation worker NAL).

Brown indicates result is greater than both excavation worker NAL and background values.

Blue indicates result is greater than RGA SSL.

(NOTE: Cell is color coded for exceeding RGA SSL only if result does not exceed NAL or background value.)

**Table 4.11. Inter-Cell Sample Locations and Depths of the Contaminants Detected above Screening Levels in SWMU 4 for Soil 1–60 ft bgs**

Color coding described in table end notes.

Analysis	ft bgs	Historical Soil Sampling Locations									Phase 2 Soil Sampling Locations		
		004-019	004-037	004-038	004-048	004-051	004-053	004-054	004-055	004-056	004-002P2	004-003P2	004-002P2
<i>Metals (mg/kg)</i>													
Arsenic	01-05		6.96	ND								2.63	
	05-10	ND	ND	ND	ND						3.44	2.39	ND
	10-15		ND	ND	ND						2.14	3.65	4.11
	15-20	ND									ND	ND	ND
	20-25	ND	ND	ND		ND							
	25-30		ND										
	35-40	ND											
	40-45					ND							
	45-50	ND											
	50-55					ND							
55-60	ND												
Chromium	01-05		18.4	14.4								10.2	
	05-10	11	14.6	16	14.7						13.5	11	6.04
	10-15		15.8	9.29	11.9						11.6	13	11.6
	15-20	12.5									9.41	8.64	7.77
	20-25	42.3	10.4	13.3		6.2							
	25-30		13.8										
	35-40	12.1											
	40-45					10.9							
	45-50	9.76											
	50-55					7.41							
55-60	23.9												
Cobalt	01-05		13	3.31									
	05-10	2.06	5.45	8.04	5.02								
	10-15		4.32	4.43	2.11								
	15-20	4.37											
	20-25	3.44	1.8	4.29		1.61							
	25-30		4.36										
	35-40	5.24											
	40-45					1.89							
	45-50	15.6											
	50-55					2.69							
55-60	8.04												
Iron	01-05		23200	19600								7960	
	05-10	8360	15600	13400	9250						12300	9730	10500
	10-15		10300	5010	5150						7130	11000	11800
	15-20	16000									6250	10200	8890
	20-25	20500	3980	6270		5100							
	25-30		22900										
	35-40	34500											
	40-45					3750							
	45-50	28000											
	50-55					14900							
55-60	8780												

**Table 4.11. Inter-Cell Sample Locations and Depths of the Contaminants Detected above Screening Levels in SWMU 4 for Soil 1–60 ft bgs (Continued)**

Analysis	ft bgs	Historical Soil Sampling Locations									Phase 2 Soil Sampling Locations		
		004-019	004-037	004-038	004-048	004-051	004-053	004-054	004-055	004-056	004-002P2	004-003P2	004-0022P2
Manganese	01-05		1520	177								108	
	05-10	29.3	261	126	141						88.9	206	398
	10-15		250	36.2	40.8						44.1	87.6	113
	15-20	ND									24	338	51.9
	20-25	42.9	141	339		21.7							
	25-30		34.4										
	35-40	47.7											
	40-45					30.4							
	45-50	1200											
	50-55					24.5							
55-60	147												
Mercury	01-05		ND	ND									
	05-10	ND	ND	ND	ND								
	10-15		ND	ND	ND								
	15-20	ND											
	20-25	ND	ND	ND		ND							
	25-30		ND										
	35-40	ND											
	40-45					ND							
	45-50	ND											
	50-55					ND							
55-60	ND												
Nickel	01-05		7.61	20.4								12.6	
	05-10	6.87	13.8	25.7	24						19.7	24.6	14.9
	10-15		7.16	5.44	5.63						8.57	14.2	12.7
	15-20	8.19									5.28	5.84	5.9
	20-25	6.23	ND	6.3		ND							
	25-30		ND										
	35-40	ND											
	40-45					ND							
	45-50	12.2											
	50-55					ND							
55-60	ND												
Silver	01-05		ND	ND								ND	
	05-10	ND	ND	ND	ND						ND	ND	ND
	10-15		ND	ND	ND						ND	ND	ND
	15-20	ND									ND	ND	ND
	20-25	ND	ND	ND		ND							
	25-30		ND										
	35-40	ND											
	40-45					ND							
	45-50	ND											
	50-55					ND							
55-60	ND												
Uranium	01-05											190	
	05-10										ND	1.31	22.5
	10-15										ND	ND	ND
	15-20										ND	2.05	ND

**Table 4.11. Inter-Cell Sample Locations and Depths of the Contaminants Detected above Screening Levels in SWMU 4 for Soil 1–60 ft bgs (Continued)**

Analysis	ft bgs	Historical Soil Sampling Locations									Phase 2 Soil Sampling Locations		
		004-019	004-037	004-038	004-048	004-051	004-053	004-054	004-055	004-056	004-002P2	004-003P2	004-0022P2
<i>PCBs (mg/kg)</i>													
PCB, Total	01-05		ND	0.308				ND		4.76		ND	
	05-10	ND	ND	ND			ND	ND	ND	ND	ND	ND	0.33
	10-15		ND	ND	ND		ND	ND	ND	ND	ND	ND	ND
	15-20	ND									ND	ND	ND
	20-25	ND	ND	ND			ND		ND	ND			
	25-30		ND										
	35-40	ND											
	45-50	ND											
55-60	ND												
<i>VOAs (mg/kg)</i>													
1,2-Dimethylbenzene	01-05							ND		ND		ND	
	05-10	ND					ND	ND	ND	ND	ND	ND	ND
	10-15						ND	ND	ND	ND	ND	ND	ND
	15-20	ND						ND			ND	ND	ND
	20-25	ND					ND		ND	ND			
	25-30												
	35-40	ND											
	40-45	ND											
	45-50												
	50-55	ND											
55-60													
Benzene	01-05							ND		ND		ND	
	05-10	ND					ND	ND	ND	ND	ND	ND	ND
	10-15						ND	ND	ND	ND	ND	ND	ND
	15-20	ND						ND			ND	ND	ND
	20-25	ND					ND		ND	ND			
	25-30												
	35-40	ND											
	40-45												
	45-50	ND											
	50-55												
55-60	ND												
Carbon tetrachloride	01-05							ND		ND		ND	
	05-10	ND					ND	ND	ND	ND	ND	ND	ND
	10-15						ND	ND	ND	ND	ND	ND	ND
	15-20	ND						ND			ND	ND	ND
	20-25	ND					ND		ND	ND			
	25-30												
	35-40	ND											
	40-45												
	45-50	ND											
	50-55												
55-60	ND												



**Table 4.11. Inter-Cell Sample Locations and Depths of the Contaminants Detected above Screening Levels in SWMU 4 for Soil 1–60 ft bgs (Continued)**

Analysis	ft bgs	Historical Soil Sampling Locations									Phase 2 Soil Sampling Locations		
		004-019	004-037	004-038	004-048	004-051	004-053	004-054	004-055	004-056	004-002P2	004-003P2	004-002P2
Chloroform	01-05							ND		ND		ND	
	05-10	ND					ND	ND	ND	ND	ND	ND	ND
	10-15						ND	ND	ND	ND	ND	ND	ND
	15-20	ND						ND			ND	ND	ND
	20-25	ND					ND		ND	ND			
	25-30												
	35-40	ND											
	40-45												
	45-50	ND											
	50-55												
55-60	ND												
<i>cis</i> -1,2-DCE	01-05		ND	ND				ND		ND		ND	
	05-10	ND	ND	ND			ND	ND	ND	ND	ND	ND	ND
	10-15		ND	ND	ND		ND	ND	ND	ND	ND	ND	ND
	15-20	ND						ND			ND	ND	ND
	20-25	ND	ND	ND	ND	ND	ND		ND	ND			
	25-30		ND			ND							
	35-40	ND											
	40-45		ND			ND							
	45-50	ND											
	50-55					ND							
55-60	ND												
TCE	01-05		ND	ND				ND		ND		ND	
	05-10	ND	ND	ND			ND	ND	ND	ND	ND	ND	ND
	10-15		ND	ND	0.035		ND	ND	ND	ND	ND	ND	ND
	15-20	ND						ND			ND	ND	ND
	20-25	ND	ND	0.0064	ND	ND	ND		ND	ND			
	25-30		ND			ND							
	35-40	ND											
	40-45		ND			0.46							
	45-50	ND											
	50-55					ND							
55-60	ND												
Vinyl chloride	01-05		ND	ND				ND		ND		ND	
	05-10	ND	ND	ND			ND	ND	ND	ND	ND	ND	ND
	10-15		ND	ND	ND		ND	ND	ND	ND	ND	ND	ND
	15-20	ND						ND			ND	ND	ND
	20-25	ND	ND	ND	ND	ND	ND		ND	ND			
	25-30		ND			ND							
	35-40	ND											
	40-45		ND			ND							
	45-50	ND											
	50-55					ND							
55-60	ND												

**Table 4.11. Inter-Cell Sample Locations and Depths of the Contaminants Detected above Screening Levels in SWMU 4 for Soil 1–60 ft bgs (Continued)**

Analysis	ft bgs	Historical Soil Sampling Locations									Phase 2 Soil Sampling Locations		
		004-019	004-037	004-038	004-048	004-051	004-053	004-054	004-055	004-056	004-002P2	004-003P2	004-002P2
<i>Radionuclides (pCi/g)</i>													
Cesium-137	01-05		ND	ND				ND		0.544		0.247	
	05-10	ND	ND	ND			ND	ND	ND	ND	ND	ND	ND
	10-15		ND	ND	ND		ND	ND	ND	ND	ND	ND	ND
	15-20	ND						ND			ND	ND	ND
	20-25		ND	ND	ND	ND	ND		ND	ND			
	25-30		ND			ND							
	35-40	ND											
	40-45					ND							
	45-50	ND											
	50-55					ND							
55-60	ND												
Neptunium-237	01-05			0.34						0.367		ND	
	05-10				ND						ND	ND	ND
	10-15										ND	ND	ND
	15-20										ND	1.07	ND
Plutonium-239/240	01-05			ND						0.109		ND	
	05-10				ND						ND	ND	ND
	10-15										ND	ND	ND
	15-20										ND	0.381	ND
Technetium-99	01-05		ND	ND				ND		8.38		1.36	
	05-10	ND	ND	ND	38.8		ND	ND	ND	ND	ND	ND	ND
	10-15		ND	ND	ND		ND	ND	ND	ND	ND	ND	ND
	15-20	ND						ND			ND	ND	ND
	20-25		ND	ND		ND	ND		ND	ND			
	25-30		ND			ND							
	35-40	ND											
	40-45					ND							
	45-50	ND											
	50-55					ND							
55-60	ND												
Thorium-230	01-05											5.62	
	05-10										0.832	1.32	1.12
	10-15										0.442	0.918	0.833
	15-20										0.96	0.798	0.8
Uranium-234	01-05			8.18						26.4		5	
	05-10				47.9						0.674	0.545	0.743
	10-15										0.476	0.477	0.415
	15-20										1.08	0.593	0.422
Uranium-235	01-05		ND	ND				ND		ND		0.367	
	05-10	ND	ND	ND			ND	ND	ND	ND	ND	0.0224	0.0399
	10-15		ND	ND	ND		ND	ND	ND	ND	0.0232	0.0227	0.0238
	15-20	ND						ND			0.0414	0.0426	0.0253
	20-25		ND	ND	ND	ND	ND		ND	ND			
	25-30		ND			ND							
	35-40	ND											
	40-45					ND							
	45-50	ND											
	50-55					ND							
55-60	ND												

**Table 4.11. Inter-Cell Sample Locations and Depths of the Contaminants Detected above Screening Levels in SWMU 4 for Soil 1–60 ft bgs (Continued)**

Analysis	ft bgs	Historical Soil Sampling Locations									Phase 2 Soil Sampling Locations		
		004-019	004-037	004-038	004-048	004-051	004-053	004-054	004-055	004-056	004-002P2	004-003P2	004-002P2
Uranium-238	01-05			15.1						56.5		11.4	
	05-10				67.8						0.694	0.626	1.18
	10-15										0.439	0.666	0.468
	15-20										1.11	0.623	0.45

Blank cells indicate interval was not sampled for the specified analysis.

Maximum value shown for each depth interval.

"ND" indicates result was not detected.

Cell color coding:

Green indicates result is greater than excavation worker NAL (not greater than background).

Orange indicates result is greater than background value (not greater than excavation worker NAL).

Brown indicates result is greater than both excavation worker NAL and background values.

Blue indicates result is greater than RGA SSL.

(NOTE: Cell is color coded for exceeding RGA SSL only if result does not exceed NAL or background value.)

**Table 4.12 Sample Locations and Depths of Contaminants Detected in SWMU 4 for Soil > 60 ft bgs**

Analysis	ft bgs	004-001P4	004-002P4	004-003P4	004-004P4	004-005P4	004-006P4	004-007P4	004-008P4	004-009P4	004-010P4
<i>VOAs (mg/kg)</i>											
1,1,2-Trichloro-1,2,2-trifluoroethane	60-70	ND	ND	ND	ND	ND	ND	0.028	ND	ND	
	70-80										
	80-90	ND									
	90-100										
	100-110	ND		ND		ND					
	110-120		0.0026		ND		ND	ND	ND	ND	ND
1,1-Dichloroethene	60-70	ND	ND	ND	ND	ND	ND	ND	ND	ND	
	70-80										
	80-90	ND									
	90-100										
	100-110	ND		ND		ND					
	110-120		ND		ND		ND	ND	ND	ND	ND
1,2-Dimethylbenzene	60-70	ND	ND	ND	ND	ND	ND	0.39	ND	ND	
	70-80										
	80-90	ND									
	90-100										
	100-110	ND		ND		ND					
	110-120		ND		ND		ND	0.0014	ND	ND	ND
Acrylonitrile	60-70	ND	ND	ND	ND	ND	ND	ND	ND	ND	
	70-80										
	80-90	ND									
	90-100										
	100-110	ND		ND		ND					
	110-120		ND		ND		ND	ND	ND	ND	ND
Benzene	60-70	ND	ND	ND	0.00026	ND	ND	0.0037	ND	ND	
	70-80										
	80-90	ND									
	90-100										
	100-110	ND		ND		ND					
	110-120		ND		ND		ND	ND	ND	ND	ND
Carbon tetrachloride	60-70	ND	ND	ND	ND	ND	0.0026	ND	ND	ND	
	70-80										
	80-90	ND									
	90-100										
	100-110	ND		ND		ND					
	110-120		0.0011		ND		ND	ND	ND	ND	ND
Chloroform	60-70	ND	ND	ND	0.00097	0.0021	0.0021	0.0032	ND	ND	
	70-80										
	80-90	ND									
	90-100										
	100-110	ND		ND		ND					
	110-120		0.0057		ND		ND	ND	ND	ND	ND

**Table 4.12. Sample Locations and Depths of Contaminants Detected in SWMU 4 for Soil > 60 ft bgs  
(Continued)**

Analysis	ft bgs	004-001P4	004-002P4	004-003P4	004-004P4	004-005P4	004-006P4	004-007P4	004-008P4	004-009P4	004-010P4
<i>cis</i> -1,2-Dichloroethene	60-70	ND	ND	0.031	0.6	0.01	0.004	0.0055	ND	ND	
	70-80										
	80-90	ND									
	90-100										
	100-110	ND		ND		ND					
	110-120		0.013		ND		ND	ND	ND	0.0018	ND
Dichlorodifluoromethane	60-70	ND	ND	ND	ND	ND	ND	ND	ND	ND	
	70-80										
	80-90	ND									
	90-100										
	100-110	ND		ND		ND					
	110-120		ND		ND		ND	ND	ND	ND	ND
Ethylbenzene	60-70	ND	ND	ND	ND	ND	ND	0.36	ND	ND	
	70-80										
	80-90	ND									
	90-100										
	100-110	ND		ND		ND					
	110-120		ND		ND		ND	0.0013	ND	ND	ND
m,p-Xylene	60-70	ND	ND	ND	ND	ND	ND	1.1	ND	ND	
	70-80										
	80-90	ND									
	90-100										
	100-110	ND		ND		ND					
	110-120		ND		ND		ND	0.0039	ND	ND	ND
Tetrachloroethene	60-70	ND	ND	ND	ND	ND	ND	ND	ND	ND	
	70-80										
	80-90	ND									
	90-100										
	100-110	ND		ND		ND					
	110-120		ND		ND		ND	ND	ND	ND	ND
Toluene	60-70	ND	ND	ND	ND	ND	ND	0.13	ND	ND	
	70-80										
	80-90	ND									
	90-100										
	100-110	ND		ND		ND					
	110-120		ND		ND		ND	0.0015	ND	ND	ND
Total Xylene	60-70	ND	ND	ND	ND	ND	ND	1.5	ND	ND	
	70-80										
	80-90	ND									
	90-100										
	100-110	ND		ND		ND					
	110-120		ND		ND		ND	0.0053	ND	ND	ND

**Table 4.12. Sample Locations and Depths of Contaminants Detected in SWMU 4 for Soil > 60 ft bgs  
(Continued)**

Analysis	ft bgs	004- 001P4	004- 002P4	004- 003P4	004- 004P4	004- 005P4	004- 006P4	004- 007P4	004- 008P4	004- 009P4	004- 010P4
Trichloroethene	60-70	0.0025	0.0006	0.39	4.2	0.016	0.13	0.065	0.00083	ND	
	70-80										
	80-90	ND									
	90-100										
	100-110	ND		ND		0.0095					
	110-120		0.15		0.00051		0.001	ND	ND	0.0071	ND
Vinyl chloride	60-70	ND	ND	0.0015	ND	ND	ND	ND	ND	ND	
	70-80										
	80-90	ND									
	90-100										
	100-110	ND		ND		ND					
	110-120		ND		ND		ND	ND	ND	ND	ND
<i>Radionuclides (pCi/g)</i>											
Technetium-99	60-70	ND	ND	10.1	ND	ND	ND	5.78	ND	ND	
	70-80										
	80-90	ND									
	90-100										
	100-110	ND		ND		ND					
	110-120		ND		ND		ND	ND	ND	ND	ND

Blank cells indicate interval was not sampled for the specified analysis.  
Maximum value shown for each depth interval.  
"ND" indicates result was not detected.

Uranium was the most commonly detected metal that exceeded both background and risk-based levels. Only uranium was detected above the excavation worker AL of 2,950 mg/kg in four samples. Uranium concentrations ranged up to 11,100 mg/kg. The highest concentrations of uranium were found in Burial Cells 2 and 4, primarily in the 5- to 10-ft interval. Figure 4.5 shows the subsurface uranium contamination associated with SWMU 4.

The following metals were detected in SWMU 4 subsurface soil above both the SSLs for the protection of UCRS groundwater and the background screening levels: aluminum, arsenic, barium, cadmium, cobalt, copper, iron, lead, manganese, mercury, nickel, selenium, silver, uranium, vanadium, and zinc. The following were detected above the SSLs for protection of RGA groundwater and the background screening levels: arsenic, cobalt, iron, manganese, mercury, nickel, silver, and uranium. Of the analytes exceeding the RGA SSL value, only iron, nickel, and uranium exceeded background in more than 10% of the analyses.

### **PCBs**

Total PCBs were detected in subsurface soils above the excavation worker NALs in 12 out of 166 of the analyses. The maximum detected value was 38 mg/kg of total PCBs in Burial Cell 4, but Burial Cells 1, 2, and 5 also had PCB detections greater than 10 mg/kg (the second highest detection of 27 mg/kg was in Burial Cell 5). The highest levels of PCBs all were within the upper 10 ft of the subsurface.

Total PCBs were detected in SWMU 4 subsurface soil above the SSL for the protection of UCRS groundwater in 12% of the analyses and above the SSL for protection of RGA groundwater in 3% of the analyses.

### **SVOCs**

No SVOCs (as analyzed using laboratory method SW-846-8270) were detected above the excavation worker NALs or ALs in the SWMU 4 subsurface soil. Naphthalene was detected in one sample (at 9.9 mg/kg), which exceeded the SSL for protection of UCRS groundwater and the SSL for protection of RGA groundwater.

### **VOCs**

Several VOCs were detected in subsurface soil at SWMU 4. VOCs detected in more than five percent of the analyses included 1,1-DCE, chloroform, *cis*-1,2-DCE, methylene chloride, tetrachloroethene, total xylene, TCE, and vinyl chloride. TCE and *cis*-1,2-DCE were the most commonly detected VOCs. No VOCs exceeded the excavation worker NAL. Detected TCE concentrations in subsurface soil was as high as 750 mg/kg. TCE and its degradation products were not detected in Burial Cell 2 or within the upper 40 ft of Burial Cell 3.

TCE is widely present (detected in 124 of 400 analyses) in subsurface samples. The highest levels (up to 750 mg/kg) are found in the subsurface soils associated with Burial Cells 1 and 4 (the maximum level within the upper 20 ft of soil within a burial cell was 1.5 mg/kg in Burial Cell 1). All analyses of subsurface soil with TCE detections greater than 1 mg/kg (35 analyses) are associated with Burial Cells 1 and 4, while all analyses with detections greater than or equal to 5.5 mg/kg (19 analyses) are associated with soil beneath Burial Cell 4. Figure 4.6 illustrates distribution of TCE in subsurface soil at the unit and shows the highest detections in the southern half of the SWMU. In addition, Figure 4.7 shows a three-dimensional interpretation of the TCE in the subsurface above the RGA. TCE was found throughout the vertical profile, from 20 ft to 60 ft bgs, with the maximum detection found in the 25 to 30-ft depth interval in boring 004-019P3.

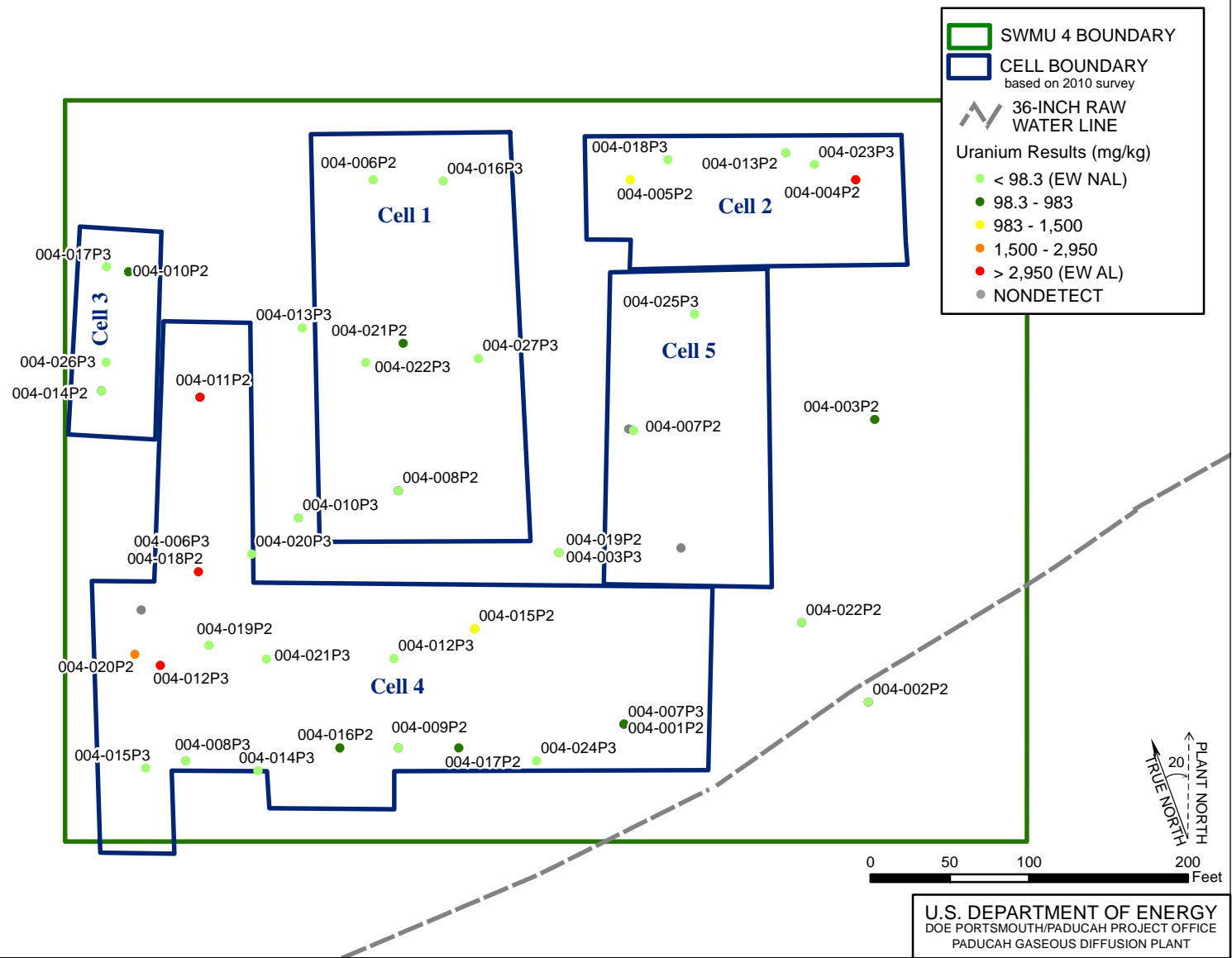

Figure 4.5. BGOU RI Addendum Subsurface Soil Uranium (Metal) Results

U.S. DEPARTMENT OF ENERGY  
DOE PORTSMOUTH/PADUCAH PROJECT OFFICE  
PADUCAH GASEOUS DIFFUSION PLANT

G:\GIS\ARCVIEWS\PROJECTS\BGOU\SWMU 4Addendum\_SubSoilSamples\_Uranium.mxd  
5/23/2016



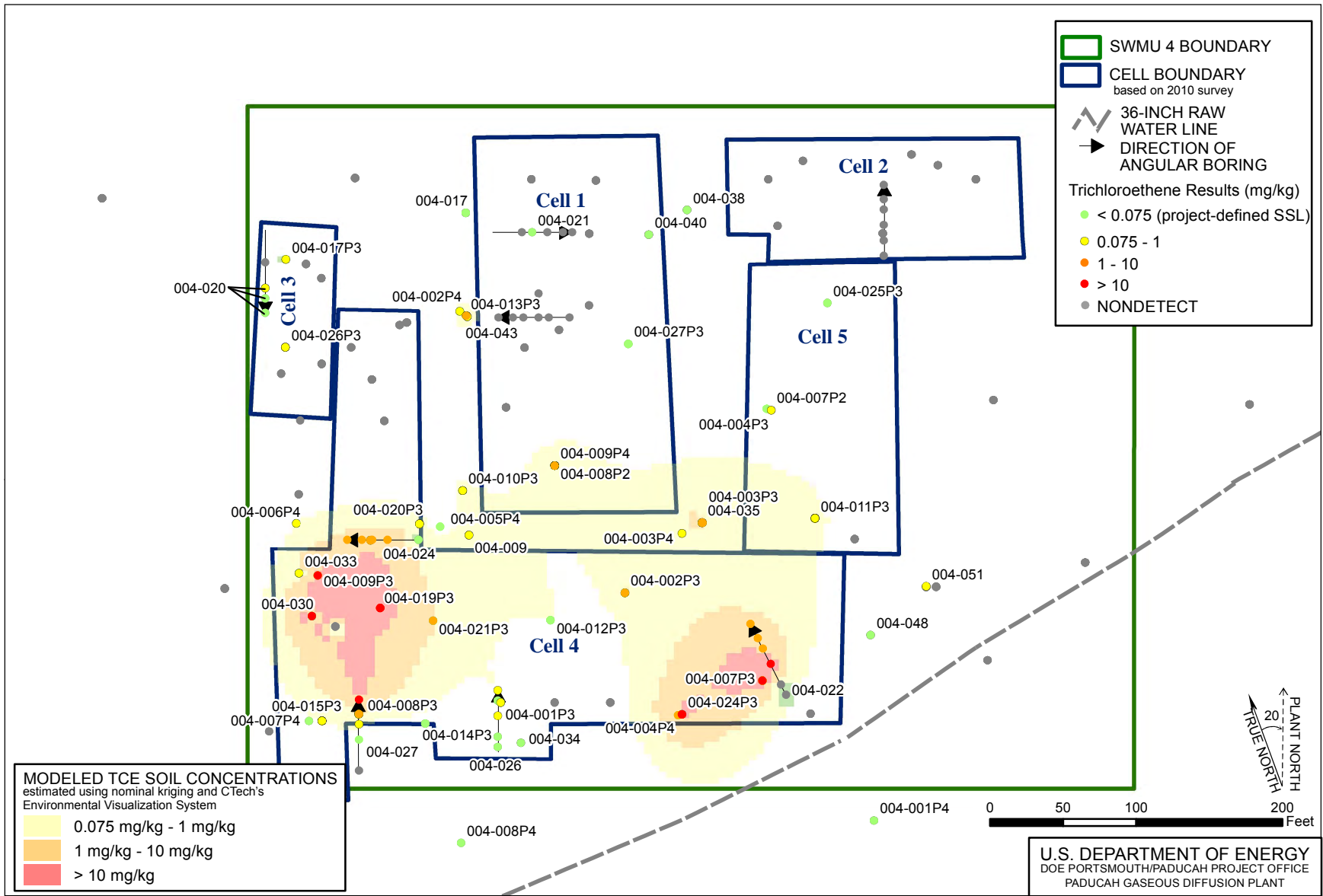

Figure 4.6. BGOU RI Addendum Subsurface Soil Trichloroethene Results



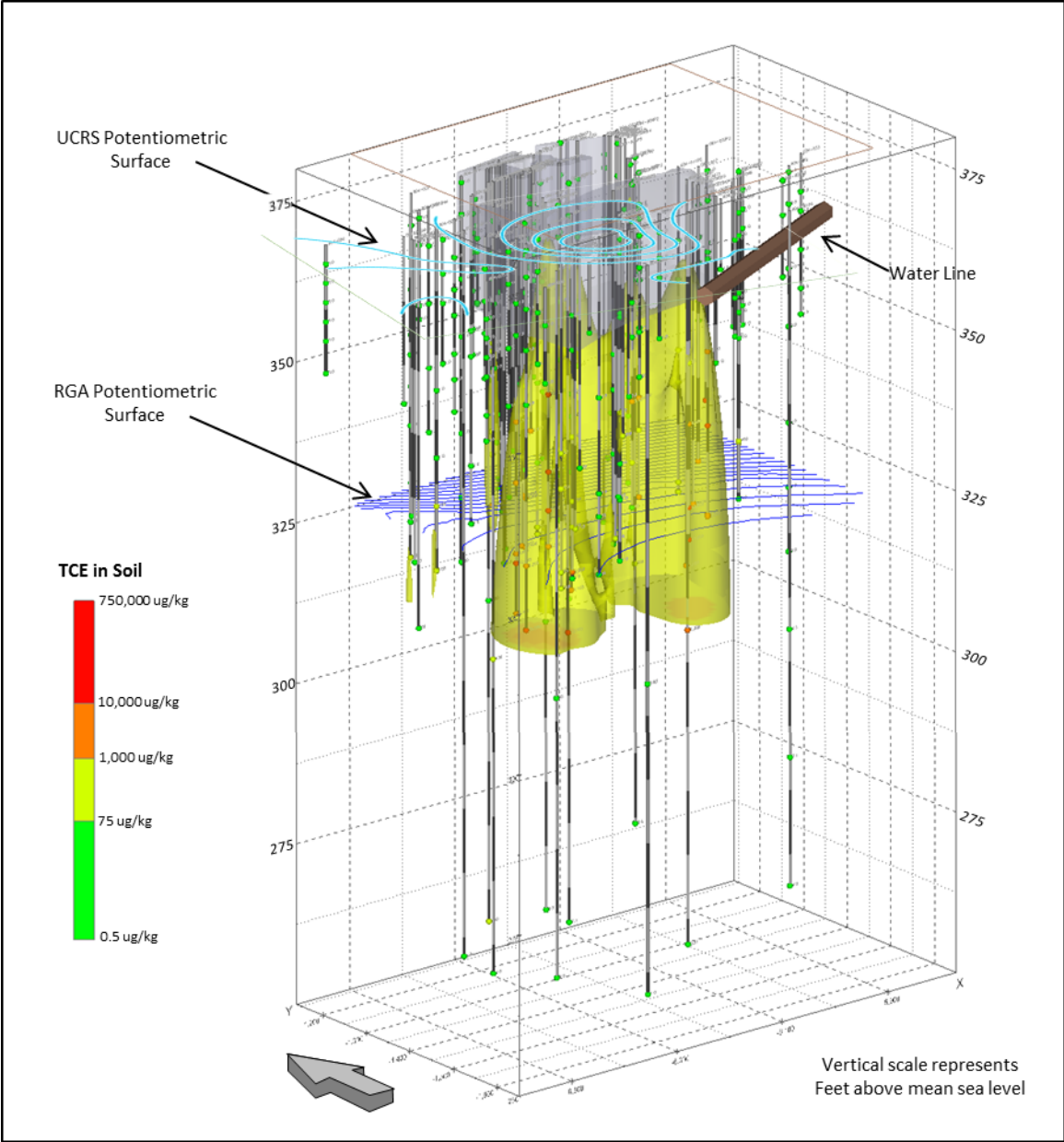

Figure 4.7. TCE in Subsurface Soil (Modeled Distribution)

Subsurface soil analyses also document the TCE degradation products vinyl chloride, detected in 67 of 400 subsurface sample analyses, and *cis*-1,2-DCE that was detected in 67 of 400 analyses. Vinyl chloride concentrations ranged up to 2.8 mg/kg and *cis*-1,2-DCE ranged up to 14.2 mg/kg. The maximum concentrations of both constituents were found below the southeastern portion of Burial Cell 4 in the 35 to 40-ft bgs interval in boring 004-007P3. Figure 4.8 shows the distribution of vinyl chloride compared to different screening levels; and the pattern is similar to the distribution of TCE, as would be expected.

The following VOCs were detected above the SSL for the protection of UCRS groundwater: 1,1,2-trichloroethane (TCA), 1,1-DCE, 1,2-dimethylbenzene, benzene, carbon tetrachloride, chloroform, *cis*-1,2-DCE, ethylbenzene, m,p-xylene, tetrachloroethene, toluene, total xylene, *trans*-1,2-DCE, TCE, and vinyl chloride. The VOCs that were detected above the SSL for protection of RGA groundwater included these: 1,2-dimethylbenzene, benzene, carbon tetrachloride, chloroform, *cis*-1,2-DCE, tetrachloroethene, TCE, and vinyl chloride. TCE was the most common contaminant to exceed the SSL for protection of RGA groundwater, with 63 of 400 analyses exceeding the value. Similar to the vertical distribution of TCE, both *cis*-1,2-DCE and vinyl chloride exceeded groundwater protection SSLs from approximately 15 ft to 60 ft bgs.

To help select Phase II subsurface sampling locations, passive soil gas samplers were deployed at SWMU 4 from September 24, 2012, to October 9, 2012. Field samples were collected from 65 locations, and the adsorbent cartridges from the passive gas samplers were desorbed thermally and analyzed using gas chromatography/mass spectrometry equipment. Vapor detections were sporadic with detections at five locations (Figure 4.9). There were two locations with vapor detections of TCE in Burial Cell 3 (29 ng/sampler) and Burial Cell 4 (54 ng/sampler). There were two locations with BTEX compounds in Burial Cell 2 (total BTEX of 92 ng/sampler) and Burial Cell 4 (total BTEX of 28 ng/sampler). In addition, one location had a detection of 1,1,2-trichloro-1,2,2-trifluoroethane (Freon 113) of 27 ng/sampler in Burial Cell 4. It should be noted that, with the detection in Burial Cell 3 and the three detections in Burial Cell 4, adjacent soil borings did not indicate any of the clay cap material; however, no definitive conclusions could be made regarding the effect of the clay cap on vapor sampling. The vapor detection at Burial Cell 2 occurs in an area where the cap is present. Burial Cell 4 had several detections of VOCs in the shallow subsurface soil so it would be reasonable to expect a greater likelihood that vapor detections would occur in that area. It also should be noted that several detections of VOCs occurred in the shallow subsurface soil in Burial Cell 5, but there were no vapor detections in the area where the cap was absent; therefore, there is not a clear correlation with the presence or absence of the clay cap and soil vapor detections. There were no soil gas vapor detections in the samplers deployed near the raw water pipeline. The lab report for the passive soil gas samplers is located in Appendix A.

### **Radionuclides**

The following radionuclides were detected in SWMU 4 subsurface soil above both the background screening levels and the excavation worker NALs: cesium-137, thorium-230, uranium-234, uranium-235, and uranium-238. Cesium-137 exceeded background in approximately four percent of the analyses. The activity concentration ranged up to 46 pCi/g. Background exceedances, typically in the upper 10 ft of the subsurface, were found in all burial cells, except Burial Cell 5. The maximum cesium-137 detection of 46 pCi/g was found in Burial Cell 1. Thorium-230 exceeded background in approximately 12% of the analyses with an activity concentration as high as 727 pCi/g. All background exceedances of thorium-230 occurred in the upper 10 ft of subsurface soil, with the two highest detections associated with Burial Cell 4. Neptunium-237, with a maximum activity concentration of 100 pCi/g, exceeded the excavation worker NAL in 7 of 95 analyses. Plutonium-239/240 exceeded the excavation worker NAL in 1 of 96 analyses, with a maximum activity concentration of 71.1 pCi/g.

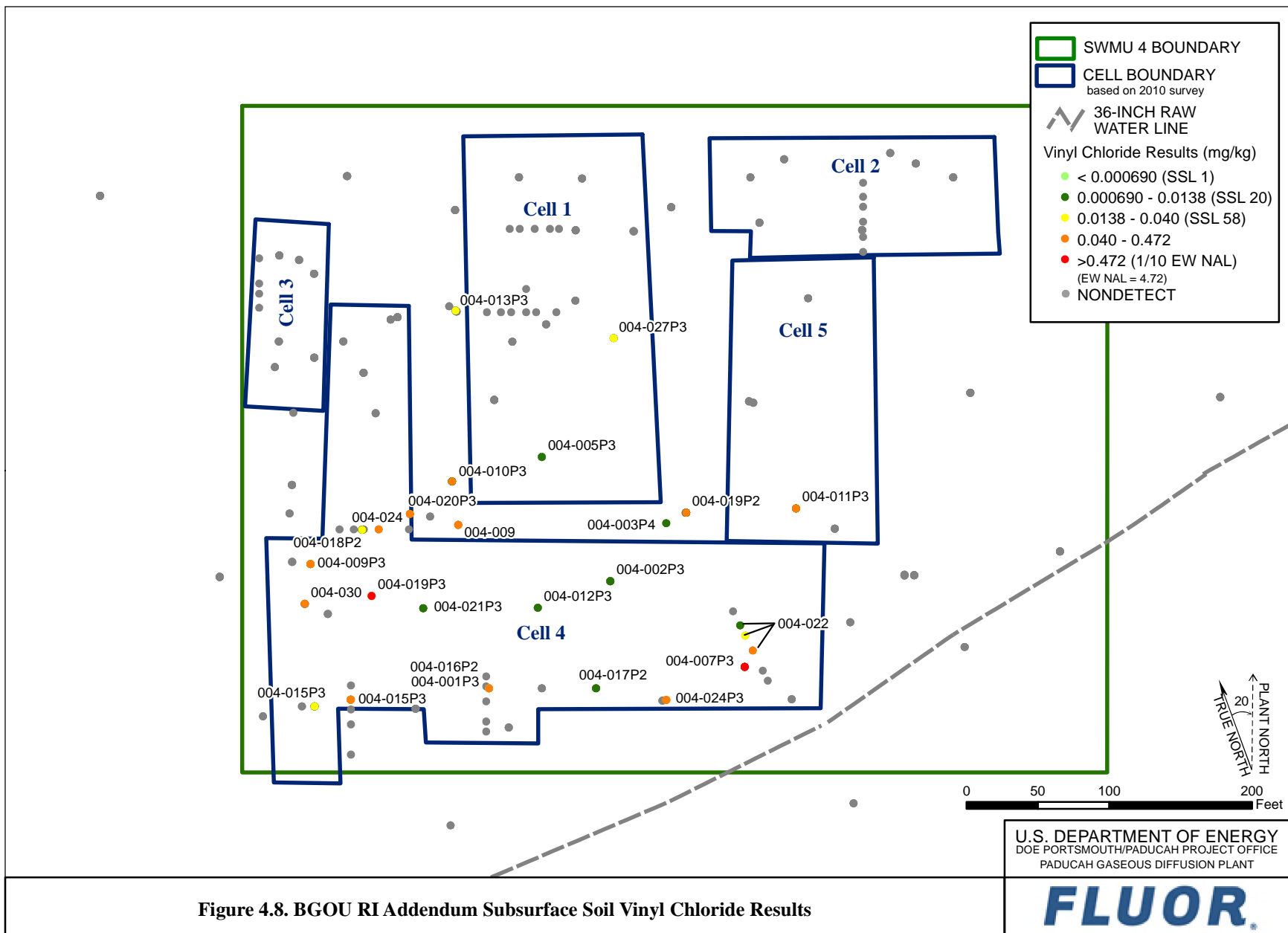

Figure 4.8. BGOU RI Addendum Subsurface Soil Vinyl Chloride Results

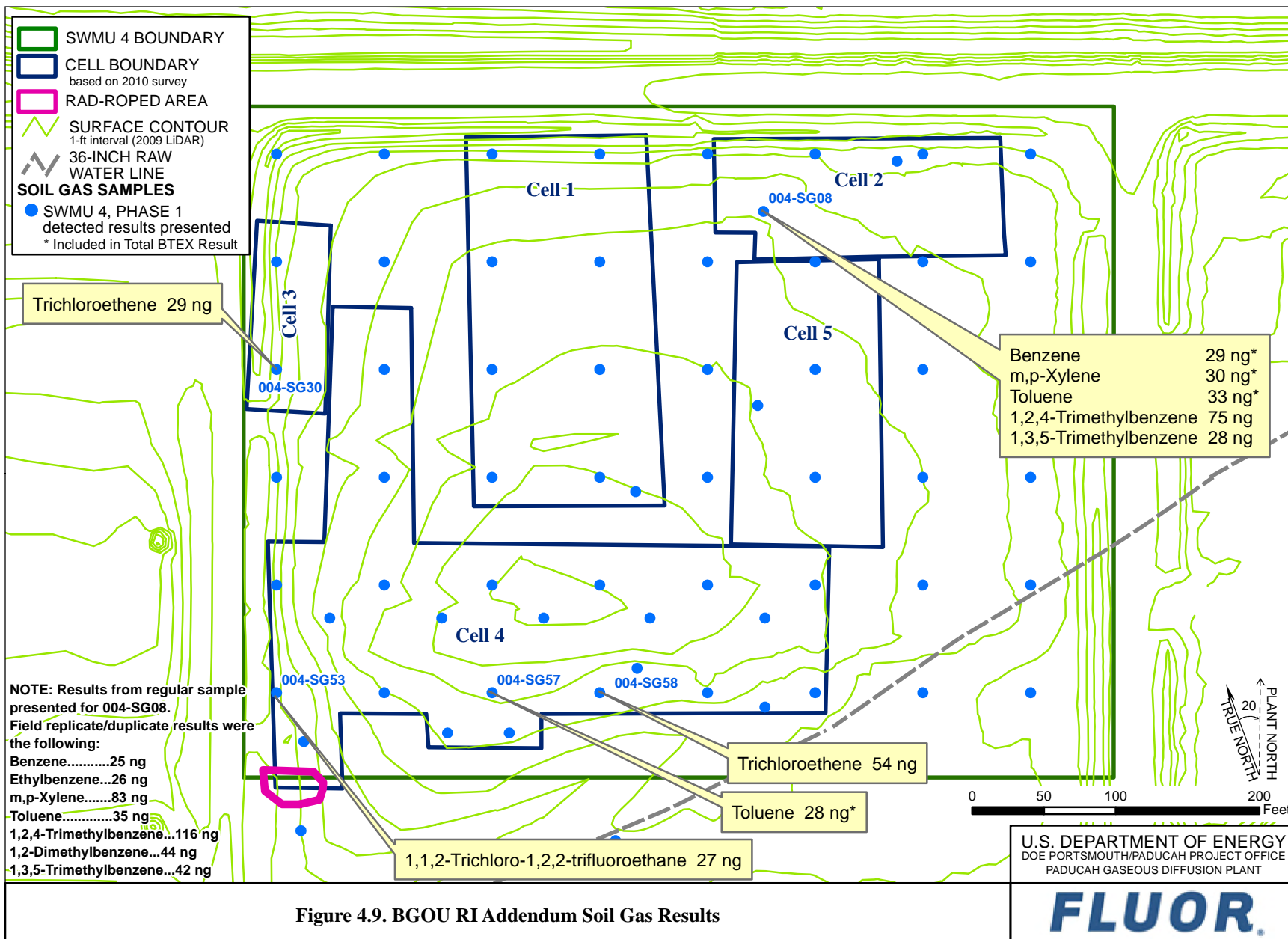

Figure 4.9. BGOU RI Addendum Soil Gas Results

The uranium isotopes were the most common to exceed both background and risk-based levels. Uranium-235 (1 sample) and uranium-238 (3 samples) also exceeded the excavation worker ALs. The range of detected activities of uranium-235 was up to 260 pCi/g (the excavation worker AL for uranium-235 is 220 pCi/g). The maximum detected activity of uranium-238 was 6,210 pCi/g (the excavation worker AL for uranium-238 is 872 pCi/g). Uranium-234 ranged up to 4,170 pCi/g (the excavation worker AL for uranium-234 is 4,350 pCi/g). The background and excavation worker risk level exceedances are mostly found in the subsurface from 1 to 10 ft deep and occur across the entire SWMU. The maximum detected activities of the uranium isotopes are found in Burial Cell 4 in the 5 to 10 ft interval. Figure 4.10 shows the uranium-238 contamination associated with SWMU 4.

The following were detected above both the background screening levels and SSLs for the protection of UCRS groundwater: cesium-137, Tc-99, thorium-230, uranium-234, uranium-235, and uranium-238. These same radionuclides also exceeded both background screening levels and the SSL for protection of RGA groundwater. Other radionuclides that do not have a PGDP provisional background value for comparison but exceeded the groundwater protection SSLs include neptunium-237, plutonium-238, and plutonium-239/240. The radionuclides that most commonly exceeded the SSL for protection of RGA groundwater include Tc-99, uranium-234, and uranium-238. Tc-99 exceeded background in almost 10% of the analyses with detectable activity ranging up to 1,050 pCi/g. Tc-99 exceeded the UCRS and RGA SSL in all analyses with detections (detection frequency was 13%). The three highest detections of Tc-99 were in the 5- to 10-ft interval in Burial Cell 4, but all burial cells had Tc-99 activity concentrations exceeding both background and the SSL value. Figure 4.11 shows the areal distribution of Tc-99 contamination at SWMU 4.

## 4.4 GROUNDWATER

Prior to the recent investigation, the WAG 3 RI (DOE 2000a) provided the majority of data to characterize groundwater at SWMU 4. Temporary borings of the Southwest Plume SI (DOE 2007a) and a sitewide remedial evaluation for source areas (DOE 2000b) supplied additional RGA data for the SWMU 4 area. Data from these historical investigations were combined with data from the current investigation to create a comprehensive data set for evaluation of groundwater at SWMU 4.

### 4.4.1 Upper Continental Recharge System

The WAG 3 RI (DOE 2000a) provided analyses of UCRS groundwater from 26 temporary borings, shown in Figure 1.5 of this report (NOTE: 27 temporary borings are shown in Figure 1.5; location 004-058 is RGA only). For the SWMU 4 investigation, more than 30 groundwater samples were collected from 7 shallow MWs and direct-push borings. The following metals exceeded at least one of the UCRS screening criteria: aluminum, arsenic, barium, beryllium, cadmium, chromium, cobalt, copper, iron, fluoride, lead, manganese, mercury, nickel, selenium, vanadium, and zinc (Table 4.13). The metals which most commonly exceeded all screening criteria in UCRS groundwater were arsenic, barium, beryllium, cadmium, chromium, and lead.

Total PCBs and two semivolatiles [bis(2-ethylhexyl)phthalate and naphthalene] exceeded at least one of the screening criteria in the UCRS. Only PCBs, with a range of detected values up to 0.422 mg/L, exceeded the MCL of 0.0005 mg/L. PCBs were detected in 11 of 16 analyses and exceeded the MCL in 9 analyses.

VOCs that exceeded at least one of the UCRS screening criteria included 1,1-dichloroethene, benzene, carbon tetrachloride, chloroform, *cis*-1,2-DCE, ethylbenzene, tetrachloroethene, *trans*-1,2-DCE, TCE, and vinyl chloride. TCE and associated degradation products were the most common volatiles detected with detection frequencies greater than 25%. Maximum TCE concentration in UCRS groundwater was

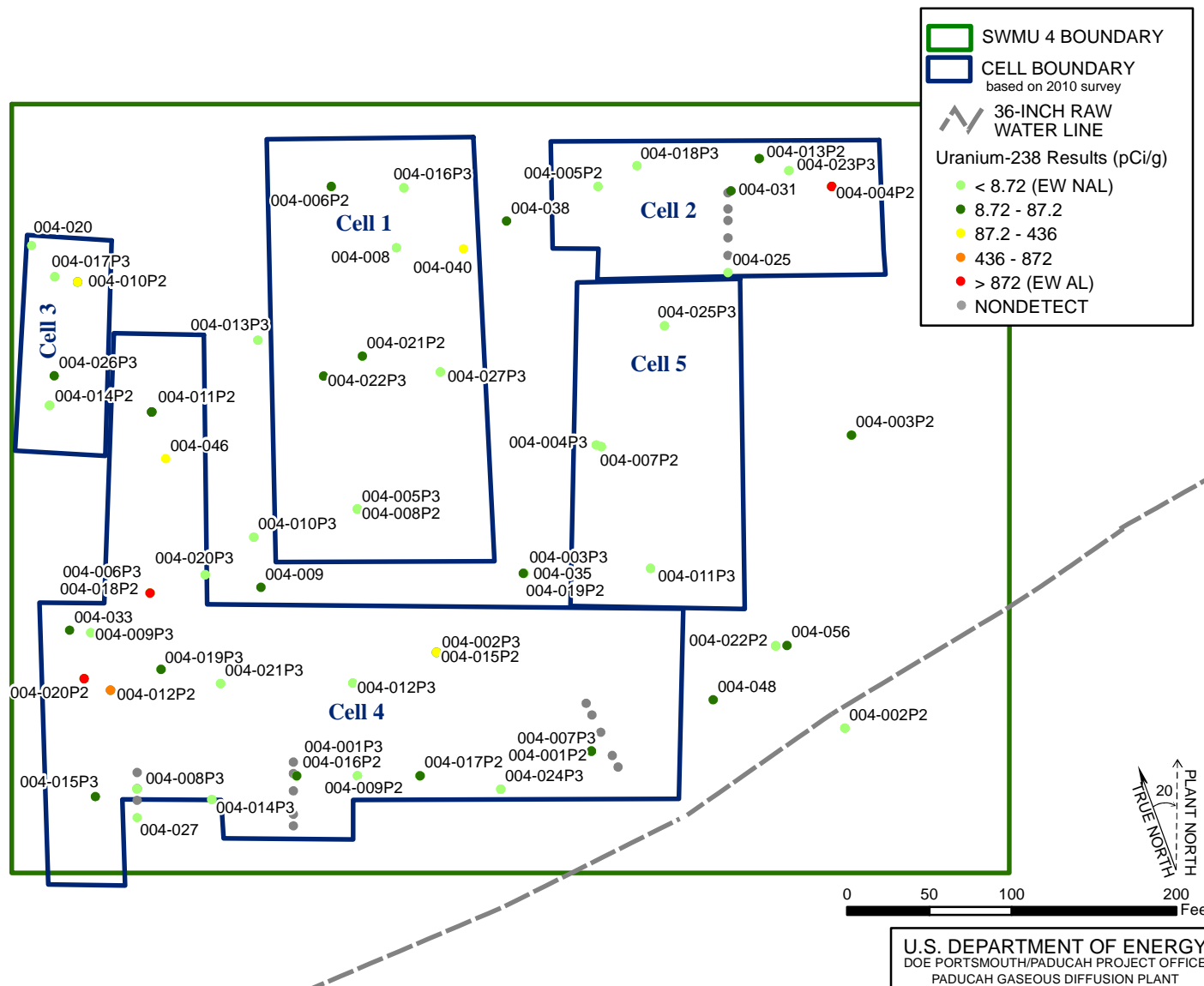

Figure 4.10. BGOU RI Addendum Subsurface Soil Uranium-238 Results

**FLUOR**

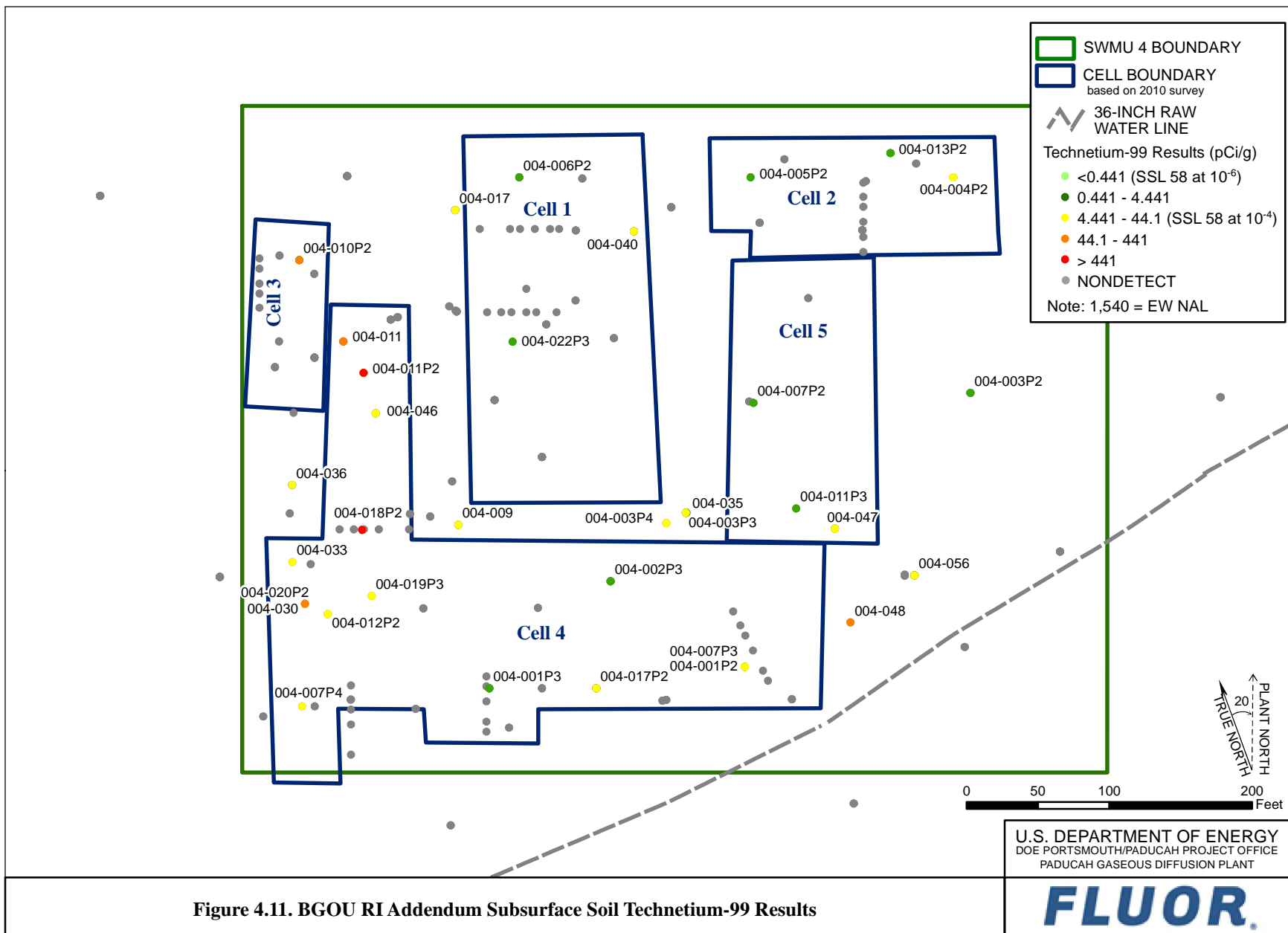

Figure 4.11. BGOU RI Addendum Subsurface Soil Technetium-99 Results



**Table 4.13. SWMU 4 UCRS Groundwater Contaminants**

Analysis	Detected Results		FOD	FOE Provisional Background	FOE Resident NAL	FOE Resident AL	FOE MCL
	Minimum	Maximum					
<b>Inorganics—Metals (mg/L)</b>							
Aluminum	2.48E-01	1.27E+03	24/40	N/A	16/40	14/40	N/A
Arsenic	5.00E-03	3.11E-01	24/34	N/A	24/34	23/34	21/34
Barium	5.60E-02	1.36E+01	38/40	N/A	12/40	2/40	10/40
Beryllium	5.00E-03	1.30E-01	13/36	N/A	13/36	10/36	13/36
Cadmium	1.00E-02	3.10E-02	7/27	N/A	7/27	1/27	7/27
Chromium	1.26E-01	5.11E+00	16/40	N/A	5/40	0/40	16/40
Cobalt	1.20E-02	3.58E+00	38/40	N/A	38/40	35/40	N/A
Copper	8.90E-02	1.55E+00	15/38	N/A	15/38	0/38	1/38
Fluoride	1.50E-01	3.10E-01	3/3	N/A	3/3	0/3	0/3
Iron	2.24E-01	2.56E+03	34/40	N/A	28/40	16/40	N/A
Lead	2.04E-01	1.00E+00	10/32	N/A	10/32	10/32	10/32
Lithium	1.48E-01	1.48E-01	1/2	N/A	N/A	N/A	N/A
Manganese	4.02E-01	1.18E+02	40/40	N/A	40/40	27/40	N/A
Mercury	7.00E-04	6.40E-03	8/33	N/A	8/33	0/33	2/33
Nickel	5.70E-02	1.26E+00	14/35	N/A	14/35	1/35	N/A
Selenium	1.00E-02	1.50E-02	3/20	N/A	3/20	0/20	0/20
Strontium	6.39E-01	6.39E-01	1/2	N/A	N/A	N/A	N/A
Vanadium	1.25E-01	4.01E+00	14/38	N/A	14/38	12/38	N/A
Zinc	2.08E-01	8.20E+00	25/40	N/A	16/40	0/40	N/A
<b>Organics—PCBs and SVOAs (mg/L)</b>							
PCB, Total	2.70E-04	4.22E-01	11/16	N/A	11/16	1/16	9/16
Bis(2-ethylhexyl)phthalate	7.00E-03	1.20E-02	2/17	N/A	2/17	0/17	N/A
Diethyl phthalate	7.00E-03	3.00E-02	2/17	N/A	N/A	N/A	N/A
Naphthalene	7.00E-03	7.00E-03	1/25	N/A	1/25	0/25	N/A
<b>Organics—VOAs (mg/L)</b>							
1,1,2-Trichloro-1,2,2-trifluoroethane	3.50E-04	6.10E-01	5/32	N/A	N/A	N/A	N/A
1,1-Dichloroethene	3.00E-04	3.40E-01	17/63	N/A	17/63	7/63	10/63
1,2-Dimethylbenzene	3.80E-04	5.80E-03	7/43	N/A	N/A	N/A	N/A
2-Butanone	3.10E-02	3.10E-02	1/11	N/A	N/A	N/A	N/A
Acetone	1.40E-02	1.00E+01	5/11	N/A	N/A	N/A	N/A
Benzene	3.10E-04	1.32E-02	13/43	N/A	11/43	0/43	3/43
Carbon tetrachloride	2.65E-01	2.75E-01	2/43	N/A	2/43	2/43	2/43
Chloroethane	1.90E-02	1.90E-02	2/11	N/A	N/A	N/A	N/A
Chloroform	8.50E-04	1.25E+01	7/43	N/A	7/43	4/43	4/43
cis-1,2-Dichloroethene	4.00E-04	2.82E+01	36/63	N/A	31/63	21/63	22/63
Ethylbenzene	3.20E-04	2.20E-03	6/43	N/A	1/43	0/43	0/43
m,p-Xylene	8.60E-04	6.80E-03	7/43	N/A	N/A	N/A	N/A
Tetrachloroethene	8.90E-04	3.16E-02	4/43	N/A	2/43	0/43	1/43
Toluene	3.40E-04	1.03E-02	11/43	N/A	N/A	N/A	N/A
Total Xylene	1.30E-03	1.30E-02	7/32	N/A	N/A	N/A	N/A
trans-1,2-Dichloroethene	2.00E-04	1.10E-01	13/31	N/A	5/31	0/31	1/31
Trichloroethene	4.00E-04	1.97E+02	44/62	N/A	44/62	33/62	35/62
Vinyl chloride	2.00E-04	2.80E+00	18/63	N/A	18/63	15/63	15/63
<b>Radionuclides (pCi/L)</b>							
Alpha activity	2.80E+00	5.27E+03	18/26	N/A	N/A	N/A	12/26
Beta activity	3.20E+00	1.49E+03	21/26	N/A	N/A	N/A	N/A
Technetium-99	1.45E+01	1.64E+03	26/44	N/A	23/44	0/44	3/44*

- One or more samples exceed NAL value (see Table 4.3).
- One or more samples exceed AL value (see Table 4.3).
- One or more samples exceed MCL (see Table 4.3).

Counts of analyses are based on the maximum detected result from a sample (i.e., if a sample has analytical results from two different labs, only the maximum value is counted). Field replicates, or separate samples are counted independently. Analyses with no detections are not listed.

\*The MCL for Tc-99 is 4 mrem/yr. The value derived by EPA from the 4 mrem/yr MCL for Tc-99 is 900 pCi/L. An alternate value derived by EPA from the 4 mrem/yr MCL is 3,790 pCi/L and was proposed in the July 18, 1991, *Federal Register*. Results in this BGOU RI Report Addendum are screened using 900 pCi/L, which is consistent with BGOU RI Report (DOE 2010a).

197,000 µg/L (Figure 4.12). Acetone, benzene, and toluene also were detected in more than 25% of the UCRS groundwater analyses, but only benzene exceeded any of the screening criteria.

Radionuclides measured in UCRS groundwater include alpha activity, beta activity, and Tc-99. Alpha activity had a maximum detected value of 5,270 pCi/L, which is greater than the MCL for gross alpha of 15 pCi/L. Tc-99 had a range of detectable values from 14.5 to 1,640 pCi/L. The maximum Tc-99 in UCRS groundwater was detected in a sample from a depth of 14 to 18 ft in boring 004-008 within Burial Cell 1. There were two samples collected below Burial Cell 4 with significantly elevated Tc-99 activity concentrations. Most of the UCRS groundwater samples with Tc-99 greater than 100 pCi/L were located along the western side of SWMU 4. Radionuclides were added to the Quality Assurance Project Plan's list of UCRS (i.e., 20 to 60 ft) analytes as part of Revision 3 (September 2014). This revision occurred prior to pit excavation. Uranium metal and uranium isotope results from UCRS water collected from the test pits are listed in Table A2.2.

#### 4.4.2 Regional Gravel Aquifer

Three temporary soil borings of the WAG 3 RI (004-028, 004-029, and 004-058), a single temporary soil boring, DG-030, from a sitewide remedial evaluation for source areas (DOE 2000b), and the SWMU 4 supplemental investigation provided groundwater analyses to characterize the RGA.

As shown in Table 4.14, several metals exceeded multiple screening levels in the RGA groundwater, but only arsenic and beryllium exceeded the MCL in more than 5% of the analyses (for metals with MCLs). Arsenic, iron, and manganese were the most common metals to exceed RGA groundwater background values (these constituents exceeded background in more than 25% of the analyses).

Several VOCs exceeded at least one of the RGA screening criteria including 1,1,2-TCA, 1,1-dichloroethane (DCA), 1,1-DCE, 1,2-DCA, 1,2-dimethylbenzene, benzene, carbon tetrachloride, chloroform, *cis*-1,2-DCE, ethylbenzene, total xylene, *trans*-1,2-DCE, TCE, and vinyl chloride. TCE was the most commonly detected VOC in the RGA, with levels that exceeded the MCL in 95% of the analyses. The maximum TCE concentrations from each sampling location are shown in Figure 4.13. TCE degradation products, notably 1,1-DCE, *cis*-1,2-DCE, and vinyl chloride also exceeded MCLs in more than 5% of the analyses. Carbon tetrachloride and chloroform also exceeded MCLs in more than 10% of the analyses.

Radionuclides exceeding multiple screening criteria in RGA groundwater include alpha activity, neptunium-237, Tc-99, and uranium-234. Alpha activity had a maximum detected value of 15.4 pCi/L, which is greater than the MCL for gross alpha of 15 pCi/L. Neptunium-237 was detected in approximately 24% of the analyses, with two detections exceeding the MCL of 15 pCi/L (the maximum detection was 22.2 pCi/L). Tc-99, with a frequency of detection of 70% of the RGA groundwater analyses, had a maximum detectable value of 663 pCi/L. Uranium-234 was detected in 1 of 4 samples.

#### 4.4.3 McNairy Formation

Several soil borings at SWMU 4 also have sampled the McNairy groundwater. Groundwater samples at SWMU 4 characterized groundwater down to 50 ft below the base of the RGA. As shown in Table 4.15, several metals exceeded multiple screening levels in the McNairy Formation groundwater, but only arsenic, barium, beryllium, cadmium, chromium, and lead exceeded the MCL in 10% or more of the analyses. While TCE and several degradation products were detected in the McNairy Formation groundwater, the only volatile organic contaminant to exceed MCLs was TCE. TCE detections in the McNairy Formation groundwater ranged up to 190 µg/L. Tc-99 exceeded the risk screening level, with a maximum activity of 37 pCi/L.

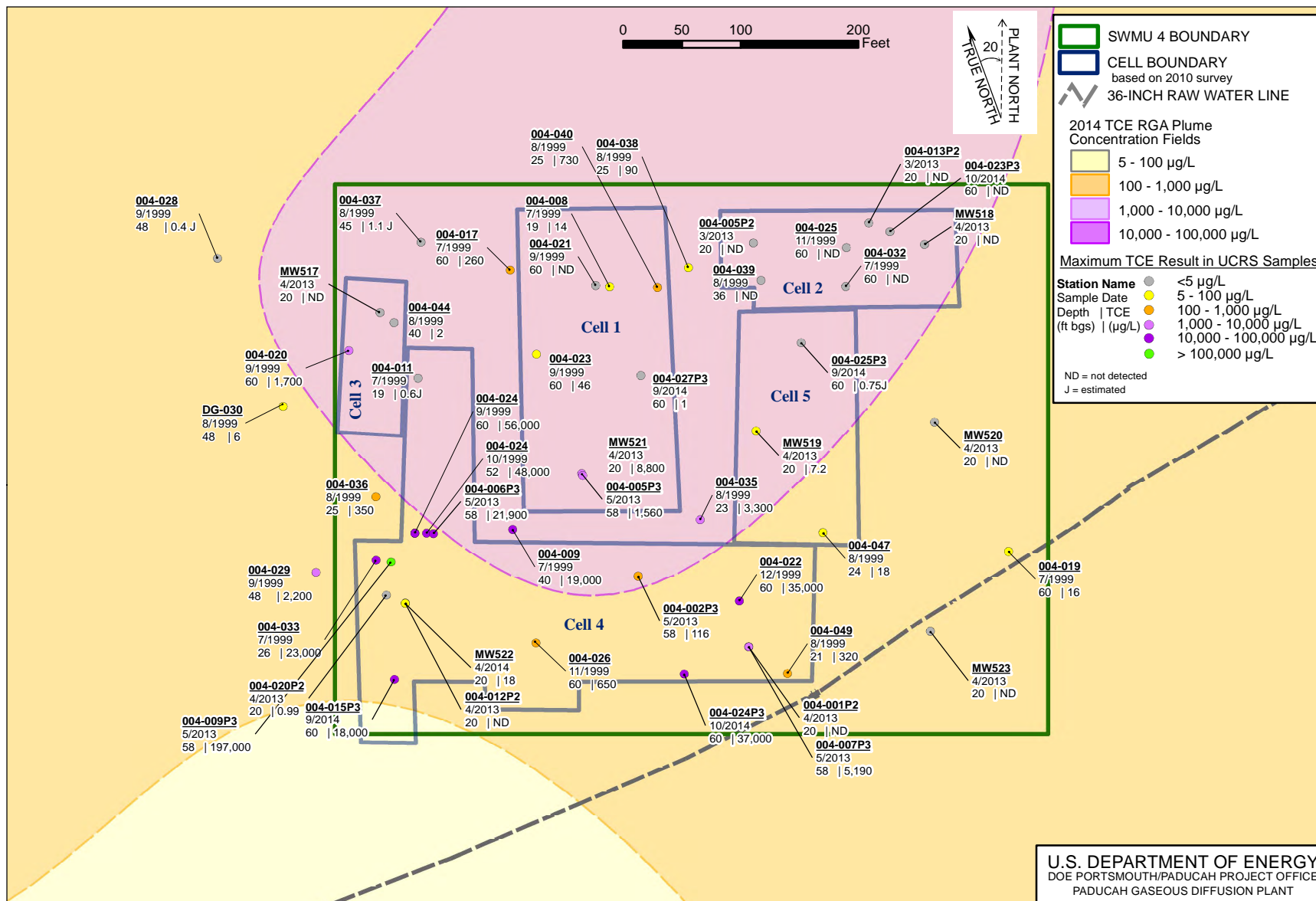

Figure 4.12. TCE in SWMU 4 UCRS Groundwater Sampling

**FLUOR**

**Table 4.14. SWMU 4 RGA Groundwater Contaminants**

Analysis	Detected Results		FOD	FOE Provisional Background	FOE Resident NAL	FOE Resident AL	FOE MCL
	Minimum	Maximum					
<b><i>Inorganics—Metals (mg/L)</i></b>							
Aluminum	2.25E-01	8.54E+02	49/124	31/124	31/124	5/124	N/A
Arsenic	1.01E-03	4.50E-02	72/89	55/89	72/89	55/89	26/89
Arsenic, Dissolved	1.88E-03	3.55E-03	5/6	0/6	5/6	0/6	0/6
Barium	6.30E-02	7.10E+00	122/125	30/125	18/125	0/125	1/125
Barium, Dissolved	9.16E-02	3.03E-01	21/21	3/21	0/21	0/21	0/21
Beryllium	6.00E-03	1.50E-01	10/80	10/80	10/80	1/80	10/80
Cadmium	5.00E-03	7.00E-03	2/61	0/61	2/61	0/61	1/61
Chromium	5.00E-02	1.52E+00	6/69	3/69	0/69	0/69	3/69
Cobalt	2.51E-03	6.10E-01	86/119	21/119	86/119	51/119	N/A
Copper	6.00E-02	5.90E-01	3/63	3/63	1/63	0/63	0/63
Fluoride	1.10E-01	3.20E-01	13/24	1/24	13/24	0/24	0/24
Iron	1.57E-01	1.83E+03	96/126	41/126	53/126	22/126	N/A
Lead	5.50E-03	2.20E-01	5/60	2/60	3/60	3/60	3/60
Lithium	9.00E-02	9.00E-02	1/13	N/A	N/A	N/A	N/A
Manganese	6.47E-03	2.58E+01	126/126	112/126	118/126	50/126	N/A
Manganese, Dissolved	6.23E-03	1.10E-02	5/6	0/6	0/6	0/6	N/A
Mercury	2.00E-04	2.20E-03	3/62	2/62	1/62	0/62	1/62
Nickel	6.52E-03	9.00E-01	13/79	1/79	11/79	0/79	N/A
Selenium	5.11E-03	1.25E-02	9/57	9/57	2/57	0/57	0/57
Strontium	5.00E-02	1.74E-01	18/27	N/A	N/A	N/A	N/A
Vanadium	9.70E-03	4.01E+00	8/67	7/67	8/67	4/67	N/A
Zinc	2.02E-01	3.54E+00	17/89	17/89	4/89	0/89	N/A
<b><i>Organics—VOAs (mg/L)</i></b>							
1,1,2-Trichloro-1,2,2-trifluoroethane	8.70E-04	5.70E-01	50/67	N/A	0/67	0/67	N/A
1,1,2-Trichloroethane	6.30E-03	6.90E-03	2/160	N/A	2/160	2/160	2/160
1,1-Dichloroethane	9.60E-04	1.70E-02	3/160	N/A	2/160	0/160	N/A
1,1-Dichloroethene	3.00E-04	4.20E-02	71/269	N/A	71/269	6/269	21/269
1,2-Dichloroethane	2.00E-01	2.00E-01	1/160	N/A	1/160	0/160	1/160
1,2-Dimethylbenzene	3.30E-03	1.20E-01	6/128	N/A	5/128	0/128	N/A
2-Butanone	6.00E-03	3.10E-02	2/65	N/A	N/A	N/A	N/A
Acetone	8.00E-03	4.90E-02	5/65	N/A	N/A	N/A	N/A
Benzene	7.10E-04	1.60E-02	10/238	N/A	10/238	0/238	1/238
Bromomethane	4.10E-03	4.10E-03	1/62	N/A	N/A	N/A	N/A
Carbon tetrachloride	1.00E-03	3.40E-01	79/238	N/A	79/238	35/238	70/238
Chloroform	1.50E-04	6.20E-01	92/238	N/A	85/238	52/238	30/238
cis-1,2-Dichloroethene	2.00E-04	2.40E+00	211/270	N/A	184/270	77/270	95/270
Dibromochloromethane	2.00E-03	2.00E-03	1/65	N/A	N/A	N/A	N/A
Dichlorodifluoromethane	5.70E-04	2.70E-03	7/93	N/A	0/93	0/93	N/A
Ethanol	4.72E-01	5.94E-01	3/15	N/A	N/A	N/A	N/A
Ethylbenzene	1.80E-03	7.80E-02	6/238	N/A	6/238	0/238	0/238
m,p-Xylene	8.10E-03	3.80E-01	6/128	N/A	N/A	N/A	N/A
Methylene chloride	1.20E-02	5.90E-01	2/65	N/A	N/A	N/A	N/A
Tetrachloroethene	1.00E-03	3.00E-03	5/238	N/A	0/238	0/238	0/238

**Table 4.14. SWMU 4 RGA Groundwater Contaminants (Continued)**

Analysis	Detected Results		FOD	FOE Provisional Background	FOE Resident NAL	FOE Resident AL	FOE MCL
	Minimum	Maximum					
<b>Organics—VOAs (mg/L) (Continued)</b>							
Toluene	2.20E-04	8.90E-02	25/238	N/A	0/238	0/238	N/A
Total Xylene	1.10E-02	5.00E-01	6/188	N/A	5/188	0/188	0/188
<i>trans</i> -1,2-Dichloroethene	2.00E-04	1.80E-02	23/192	N/A	8/192	0/192	0/192
Trichloroethene	1.00E-04	1.20E+01	311/314	N/A	310/314	296/314	300/314
Trichlorofluoromethane	6.00E-03	1.20E-01	9/26	N/A	N/A	N/A	N/A
Vinyl chloride	2.00E-04	4.50E-01	65/270	N/A	65/270	43/270	40/270
<b>Radionuclides (pCi/L)</b>							
Alpha activity	-1.37E+00	1.54E+01	49/140	15/140	N/A	N/A	1/140
Americium-241	1.90E-01	1.90E-01	1/13	N/A	0/13	0/13	0/13
Beta activity	7.00E-02	3.98E+02	110/139	77/139	N/A	N/A	N/A
Neptunium-237	9.00E-02	2.22E+01	4/17	3/17	3/17	0/17	2/17
Plutonium-239/240	-2.76E-01	5.00E-02	4/18	0/18	0/18	0/18	N/A
Radium-226	2.22E-01	2.45E-01	2/15	N/A	N/A	N/A	N/A
Radium-228	2.47E+00	7.71E+00	4/16	N/A	N/A	N/A	N/A
Technetium-99	-8.00E+00	6.63E+02	201/288	133/288	144/288	0/288	0/288*
Thorium-230	2.50E-01	5.87E-01	2/22	N/A	1/22	0/22	0/22
Thorium-234	-1.91E+02	3.62E+01	3/15	N/A	N/A	N/A	N/A
Uranium-234	9.66E+00	9.66E+00	1/4	1/4	1/4	0/4	0/4
Uranium-235	3.50E-01	3.50E-01	1/7	1/7	0/7	0/7	0/7
Uranium-238	1.40E-01	1.40E-01	1/4	0/4	0/4	0/4	0/4

- One or more samples exceed background value (see Table 4.3).
- One or more samples exceed NAL value (see Table 4.3).
- One or more samples exceed AL value (see Table 4.3).
- One or more samples exceed MCL (see Table 4.3).

Counts of analyses are based on the maximum detected result from a sample (i.e., if a sample has analytical results from two different labs, only the maximum value is counted). Field replicates, or separate samples are counted independently. Analyses with no detections are not listed.

\*The MCL for Tc-99 is 4 mrem/yr. The value derived by EPA from the 4 mrem/yr MCL for Tc-99 is 900 pCi/L. An alternate value derived by EPA from the 4 mrem/yr MCL is 3,790 pCi/L and was proposed in the July 18, 1991, *Federal Register*. Results in this BGOU RI Report Addendum are screened using 900 pCi/L, which is consistent with BGOU RI Report (DOE 2010a).

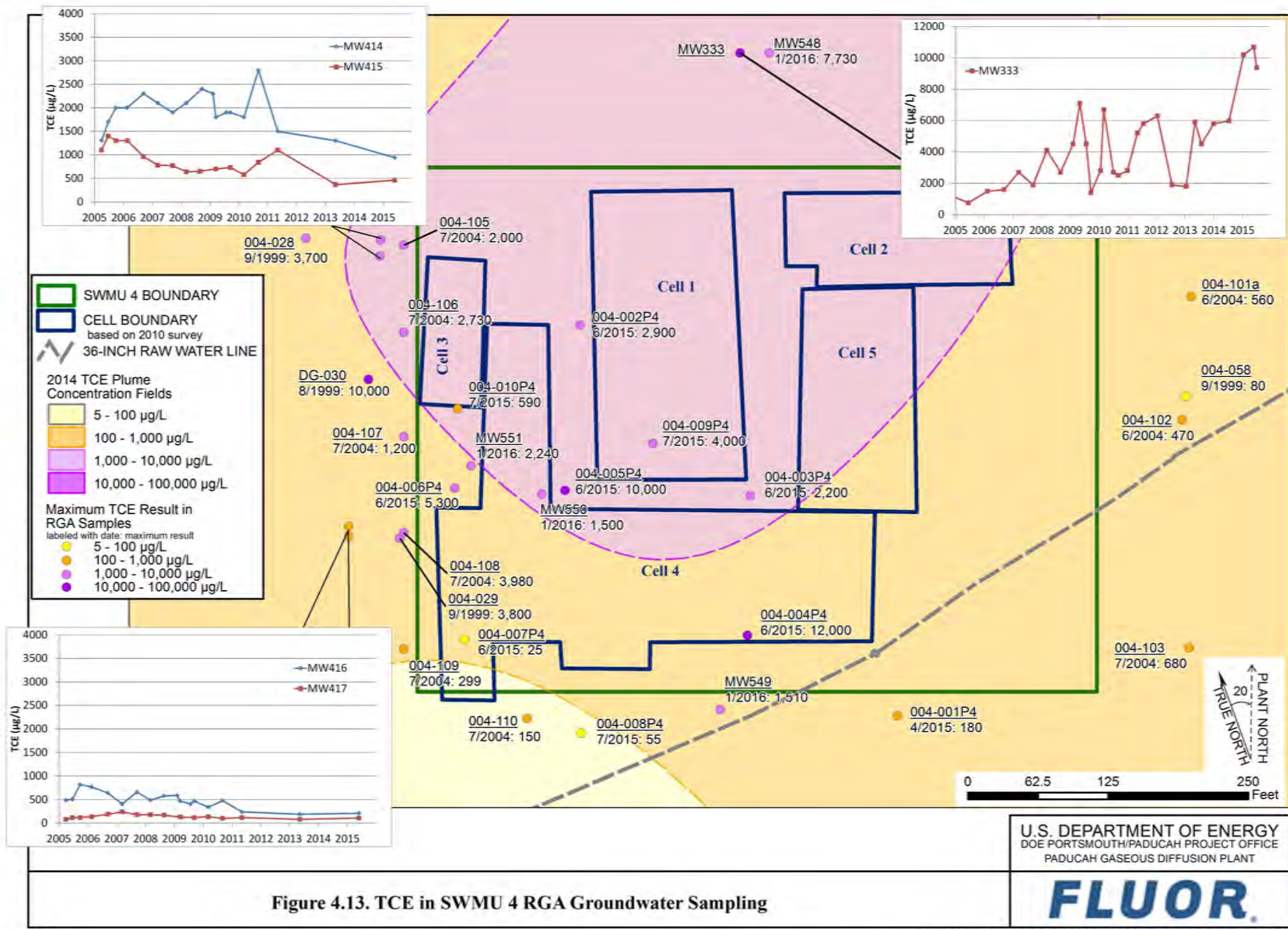

Figure 4.13. TCE in SWMU 4 RGA Groundwater Sampling

**Table 4.15. SWMU 4 McNairy Formation Groundwater Contaminants**

Analysis	Detected Results		FOD	FOE	FOE	FOE	FOE MCL
	Minimum	Maximum		Provisional Background	Resident NAL	Resident AL	
<b><i>Inorganics—Metals (mg/L)</i></b>							
Aluminum	3.97E-01	2.83E+02	15/34	12/34	12/34	8/34	N/A
Arsenic	1.10E-02	1.05E-01	6/20	6/20	6/20	6/20	6/20
Barium	5.40E-02	3.40E+00	31/34	9/34	9/34	0/34	4/34
Beryllium	1.90E-02	1.23E-01	8/28	8/28	8/28	1/28	8/28
Boron	2.47E+00	2.47E+00	1/3	N/A	1/3	0/3	N/A
Cadmium	6.00E-03	1.01E-01	8/26	7/26	8/26	3/26	8/26
Chromium	1.02E-01	6.54E-01	8/26	8/26	0/26	0/26	8/26
Cobalt	1.20E-02	1.89E+00	18/32	8/32	18/32	15/32	N/A
Copper	7.20E-02	9.37E-01	8/26	8/26	7/26	0/26	0/26
Iron	2.24E-01	2.36E+03	27/34	12/34	15/34	11/34	N/A
Lead	3.01E-01	2.15E+00	8/26	8/26	8/26	8/26	8/26
Lithium	1.41E-01	1.41E-01	1/3	N/A	N/A	N/A	N/A
Manganese	1.74E-01	2.59E+01	34/34	15/34	34/34	12/34	N/A
Mercury	3.00E-04	8.20E-03	7/26	7/26	6/26	0/26	1/26
Nickel	1.30E-01	8.00E-01	3/18	3/18	3/18	0/18	N/A
Strontium	1.56E-01	1.51E+00	3/3	N/A	N/A	N/A	N/A
Vanadium	1.12E-01	6.94E+00	9/28	8/28	9/28	8/28	N/A
Zinc	2.23E-01	9.67E+00	10/30	10/30	8/30	0/30	N/A
<b><i>Organics—VOAs (mg/L)</i></b>							
1,1-Dichloroethene	2.40E-03	4.60E-03	3/12	N/A	3/12	0/12	0/12
Acetone	1.30E-02	1.30E-02	1/1	N/A	N/A	N/A	N/A
cis-1,2-Dichloroethene	1.00E-04	1.20E-02	5/12	N/A	2/12	0/12	0/12
trans-1,2-Dichloroethene	2.00E-04	1.50E-03	4/12	N/A	0/12	0/12	0/12
Trichloroethene	1.00E-04	1.90E-01	8/12	N/A	6/12	4/12	5/12
<b><i>Radionuclides (pCi/L)</i></b>							
Alpha activity	2.20E+00	1.39E+01	12/12	1/12	N/A	N/A	0/12
Beta activity	3.40E+00	2.47E+01	12/12	0/12	N/A	N/A	N/A
Technetium-99	2.79E+01	3.70E+01	2/12	2/12	2/12	0/12	0/12*

- One or more samples exceed background value (see Table 4.3).
- One or more samples exceed NAL value (see Table 4.3).
- One or more samples exceed AL value (see Table 4.3).
- One or more samples exceed MCL (see Table 4.3).

Counts of analyses are based on the maximum detected result from a sample (i.e., if a sample has analytical results from two different labs, only the maximum value is counted). Field replicates, or separate samples are counted independently. Analyses with no detections are not listed.

\*The MCL for Tc-99 is 4 mrem/yr. The value derived by EPA from the 4 mrem/yr MCL for Tc-99 is 900 pCi/L. An alternate value derived by EPA from the 4 mrem/yr MCL is 3,790 pCi/L and was proposed in the July 18, 1991, Federal Register. Results in this BGOU RI Report Addendum are screened using 900 pCi/L, which is consistent with BGOU RI Report (DOE 2010a).

#### 4.4.4 Potential Trichloroethene Dense Nonaqueous-Phase Liquid

Sampled groundwater concentrations in excess of one percent effective solubility indicate the groundwater may have come in contact with TCE DNAPL. As a “rule-of-thumb,” the finding of dissolved concentrations that exceed one percent of the effective solubility is cause for consideration of the presence of a DNAPL phase in the subsurface (Pankow and Cherry 1996; Kueper and Davies 2009). EPA also has indicated that concentrations of DNAPL chemicals in soil greater than one percent by mass, or 10,000 mg/kg, may indicate the presence of DNAPL (EPA 1994). The WAG 6 RI report (DOE 1999b) used a soil concentration of 225 mg/kg TCE as an indicator of DNAPL (this value considers the partitioning relationships of the contaminant). Dissolved TCE in UCRS groundwater indicates that a TCE DNAPL source is likely in the subsurface at SWMU 4 (there were 10 UCRS groundwater samples, plus a field duplicate, with reported TCE concentrations greater than one percent effective solubility, or 11,000 µg/L TCE, with the maximum value of 197,000 µg/L being approximately 18% of TCE solubility). The depths of groundwater with TCE concentrations greater than 11,000 µg/L in the UCRS varied from 21 ft to 60 ft bgs and all occurred in the vicinity of Burial Cell 4 (the maximum result was detected at the base of the UCRS). TCE in soil samples did not approach the 10,000 mg/kg criterion mentioned above, but if equilibrium partitioning relationships are considered, there was one soil sample with a TCE concentration greater than 225 mg/kg. The OILSCREENSOIL (SUDAN IV)<sup>TM</sup> field test kits used on these soil samples gave no indication of the presence of DNAPL.

The Southwest Plume SI report (DOE 2007a) and BGOU RI (DOE 2010a) also interpreted a discrete area with TCE concentrations greater than 10,000 µg/L in the RGA immediately downgradient of SWMU 4, derived from a potential DNAPL zone. Identification of this area of elevated dissolved TCE is based primarily on a conceptual model of dissolved TCE levels derived from a DNAPL zone. The only confirmatory analysis from that report was a single groundwater sample from historic temporary boring DG-030, sampled in August 1999. During this BGOU RI Addendum sampling, there were two RGA groundwater samples from temporary borings that had TCE concentrations of 10,000 µg/L or greater. One sample was from the 75-ft depth interval in boring 004-004P4, and the other was from the 85-ft depth interval in boring 004-005P4. Figure 4.14 shows the vertical TCE profile of samples collected from the temporary borings in the RGA during this BGOU RI Addendum investigation. The elevated TCE concentrations in the RGA are likely a result of a TCE DNAPL in the UCRS, rather than a DNAPL within the RGA.

Based on modeled TCE distribution in Figure 4.7, the total mass of TCE in UCRS soil (at concentrations greater than 0.075 mg/kg) is estimated to be approximately 744 lb (approximately 61 gal of TCE). Note that 0.075 mg/kg of TCE is an estimated soil cleanup level based on the cleanup level calculated for TCE sources near the C-720 Building. SWMU 4 cleanup levels will be developed further in the FS. There are two areas in the subsurface with interpreted concentrations greater than 1.0 mg/kg beneath Burial Cell 4 (see Figure 4.6). One of the areas (areal extent of approximately 0.16 acres) is beneath the eastern portion of the cell, and the other (areal extent of approximately 0.23 acres) is associated with the western portion of the burial cell.



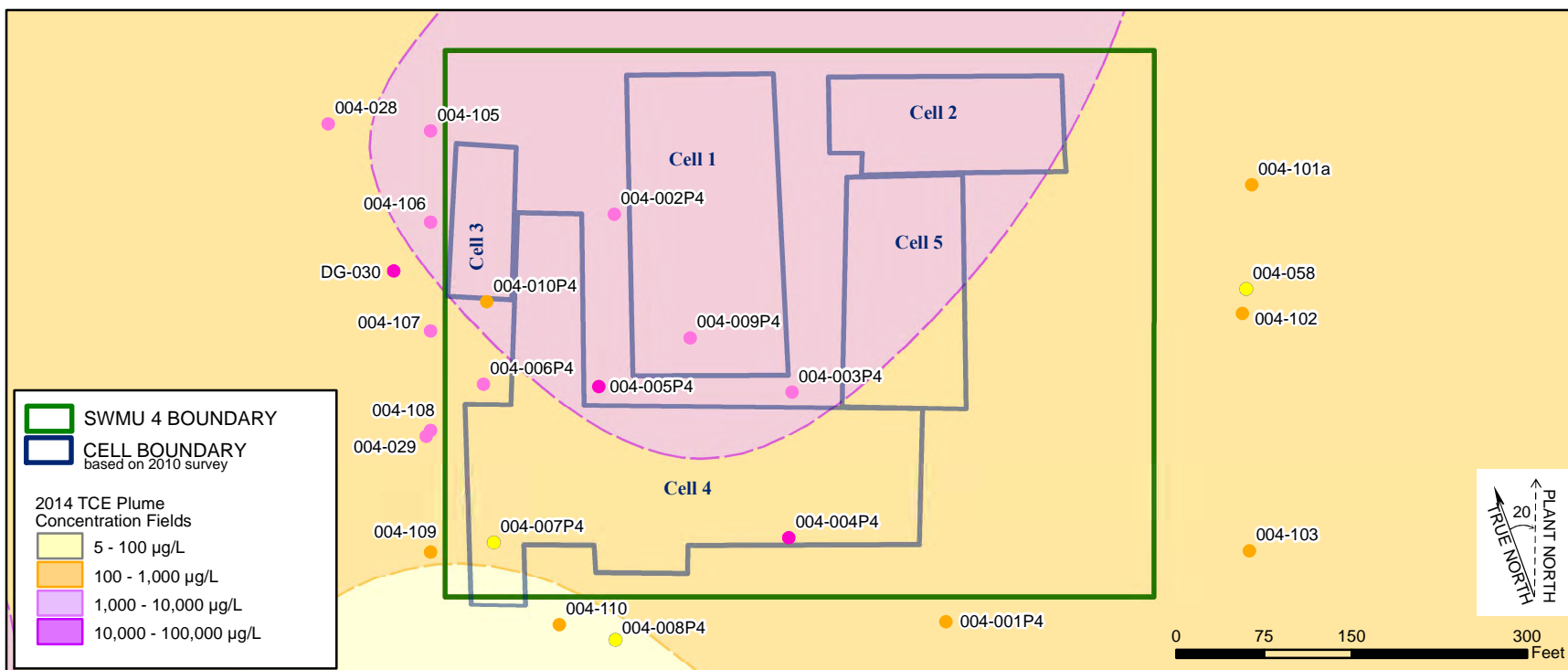

ft bgs	SWMU 4 Addendum Sampling											Historical Sampling												
	004-001P4	004-002P4	004-003P4	004-004P4	004-005P4	004-006P4	004-007P4	004-008P4	004-009P4	004-010P4	DG-030	004-028	004-029	004-058	004-101a	004-102	004-103	004-105	004-106	004-107	004-108	004-109	004-110	
60-65								0.35		590														
65-70	180		2200					2.1	1400		1600	1000	3800	1	6	ND	1.2			570			299	86
70-75	150		1200		4500	3200	3.9			550	1500	1500	2100	6				1700		1200	2860			
75-80	23	350	1600	12000	3200	5300		13	4000		2500	2100	400	18	150		99	1200	1265	1000	366	28	47	
80-85			930		7400	5000	4.1			400	1400	3700	69	42			160							
85-90		1800	510	4200	10000	3300		55	1600		1000	2000	54	80	560		680	1700	368	182	78	55	62	
90-95			360		8600	1700	4.8			320	4500	2100	110	27		470								
95-100	43	2900	570	1100	4500	1500		35	1100		10000	180	180	0.1			670	1600	2730	208	104	34	150	
100-105			490		2500	1000	4.2			310	3700													
105-110	42	1400	390	1900	1700	1200					1300													
110-115					2100	500	25																	
115-120		1600			1300	450																		

U.S. DEPARTMENT OF ENERGY  
DOE PORTSMOUTH/PADUCAH PROJECT OFFICE  
PADUCAH GASEOUS DIFFUSION PLANT

Figure 4.14. TCE in RGA Groundwater from Temporary Borings from Addendum Sampling at SWMU 4



**THIS PAGE INTENTIONALLY LEFT BLANK**

## 5. FATE AND TRANSPORT

This section provides an updated conceptual model and a summary of the fate and transport of the primary COPCs for SWMU 4 that was presented in the BGOU RI Report (DOE 2010a).

### 5.1 CONCEPTUAL MODEL

The sources of contamination to the RGA considered in this report are the burial cells and contaminated soil at SWMU 4. Releases from SWMU 4 have impacted soils below or adjacent to the burial cells; through vertical infiltration in soil, these sources have contaminated the groundwater underlying these sources. Subsequently, contaminated groundwater migrates to various points of exposure (POEs). The potential POEs for SWMU 4 that were identified in the BGOU RI report were the SWMU boundary, plant boundary, property boundary, and the Ohio River. Contaminant migration could have impacted three hydrogeologic units underlying SWMU 4. These units, which control the flow of shallow groundwater and contaminant migration, are as follows, in descending depth order:

- UCRS—approximately 60 to 65 ft of silt and clay with horizons of sand and gravel;
- RGA—approximately 40 ft of gravel and sand deposits that overlie the McNairy Formation; and
- McNairy Formation—approximately 225 ft of silty and clayey sand that forms a lower confining unit to the RGA.

Previous work has shown that groundwater flow in the UCRS is primarily vertical to the RGA and then lateral toward the Ohio River, and groundwater flow in the McNairy Formation (both vertical and lateral) is significantly slower than that in the RGA. The primary contaminant pathway for the site-related contaminants is vertical migration through the UCRS, followed by lateral migration in the RGA. The RGA discharges to the Ohio River and, for a limited number of SWMUs, to seeps along Little Bayou Creek.

A previous uncertainty, identified as a data gap in the BGOU Work Plan Addendum, was the possible role of the bedding material surrounding the raw water pipe in the southeastern portion of SWMU 4 acting as a preferential pathway for migration outside of the SWMU. Based on data collected during this investigation from passive soil gas samplers and soil samples, there is no evidence supporting the pipeline bedding being a preferred pathway for contamination at SWMU 4.

### 5.2 FATE AND TRANSPORT MODELING SUMMARY

For the BGOU RI report, modeling assessed fate and transport of contaminants for two pathways: (1) dissolved-phase transport through the aquifer and (2) vapor transport to a residential basement. Section 5 and Appendix E of the BGOU RI document the fate and transport modeling performed for SWMU 4 (DOE 2010a).

Modeling predicted the maximum concentration of analytes in groundwater at the SWMU boundary. Contaminants that were predicted to exceed the MCL at the SWMU 4 boundary included arsenic, *cis*-1,2-DCE, TCE, vinyl chloride, and Tc-99. The groundwater modeling results for SWMU 4 show that the predicted groundwater concentrations of *cis*-1,2-DCE, TCE, vinyl chloride, and Tc-99 will exceed

their respective MCLs<sup>2</sup> at the plant boundary and DOE property boundary (DOE 2010a). TCE was the only contaminant predicted to exceed the MCL at the Ohio River POE.

Vapor transport modeling assessed contaminant concentrations in a hypothetical residential basement at the SWMU and in hypothetical residential basements at the POEs. (Appendix E, Section E.3.2 of the BGOU RI documents the vapor transport modeling performed for SWMU 4.) The resident scenario provides bounding risks and hazards for the vapor pathways when compared to the industrial worker exposure scenario. Hence, the industrial worker exposure scenario was not evaluated in the vapor modeling analysis. At SWMU 4, the vapor transport modeling for TCE at the on-site, plant boundary, and property boundary POEs exceeded the ELCR of 1E-06 or a hazard of 0.1. Other contaminants exceeding the risk or hazard criteria at the on-site POE were *cis*-1,2-DCE and vinyl chloride.

### **5.3 GROUNDWATER PROTECTION SCREENING SUMMARY**

For this BGOU RI Addendum Report, surface and subsurface soil analytical results were screened against screening values for the protection of both UCRS and RGA groundwater. This screening is discussed in Section 4, with screening results provided in Tables 4.4 and 4.5. The contaminants that most commonly exceeded the screening level for the protection of RGA groundwater are summarized below.

In surface soil, the following contaminants most commonly exceeded the SSL for protection of RGA groundwater and background, where background values are available: silver, uranium and its isotopes, Total PCBs, and Tc-99.

In SWMU 4 subsurface soil, the following contaminants most commonly exceeded the SSL for protection of RGA groundwater and the background screening levels, where background values are available: iron, uranium and its isotopes, Total PCBs, TCE, *cis*-1,2-DCE, vinyl chloride, and Tc-99.

TCE was the most common VOC to exceed the SSL for protection of RGA groundwater, with 63 of 400 analyses exceeding the value. TCE and its degradation products exceeded groundwater protection SSLs from approximately 15 ft to 60 ft bgs.

---

<sup>2</sup> The MCL for Tc-99 is 4 mrem/yr. The value derived by EPA from the 4 mrem/yr MCL for Tc-99 is 900 pCi/L. An alternate value derived by EPA from the 4 mrem/yr MCL is 3,790 pCi/L and was proposed in the July 18, 1991, *Federal Register*. Results in this RI Addendum are screened using 900 pCi/L, which is consistent with BGOU RI Report (DOE 2010a).

## 6. HUMAN HEALTH RISK EVALUATION AND ECOLOGICAL RISK SCREENING

In accordance with the BGOU Work Plan Addendum, data collected from this sampling effort also has been used to conduct a risk screening for the industrial worker. More details of the screening risk assessment are provided in Appendix C.

This section provides a summary of the Baseline Human Health Risk Assessment (BHHRA) from the BGOU RI (DOE 2010a). The BGOU RI BHHRA for SWMU 4 used information collected during the WAG 3 investigation. No additional data were collected during the BGOU RI for SWMU 4. The purpose of the BHHRA was to characterize the baseline risks posed to human health from contact with contaminants in soil and water at SWMU 4 and at locations to which contaminants may migrate.

### 6.1 BGOU SWMU 4 ADDENDUM RISK SCREENING

#### 6.1.1 Risk Screening for Soils COPCs

Consistent with the BGOU Work Plan Addendum, the data collected from the sampling effort were used to conduct a risk screening for the industrial worker (DOE 2014). Because industrial worker risk screening is applicable to surface soil, excavation worker NALs were used for screening the subsurface soil. Analytes exceeding both NAL and background values (if available) were considered chemicals or radionuclides of potential concern (COPCs). Additional information regarding the screening of the data is available in Appendix C of this report.

#### 6.1.2 Derivation of Risk Estimates for Soils COPCs

For each COPC for soil, an exposure point concentration (EPC) was calculated using EPA’s ProUCL software (v.5.0), denoting nondetect values. These EPCs were compared to risk-based concentrations to determine an estimate of risk for the industrial worker scenario [direct contact with surface soil (0–1 ft bgs) and sediment for 250 days per year over a 25-year period] and for the excavation worker scenario [direct contact with surface and subsurface soil (0–20 ft bgs) for 185 days per year over a 5-year period]. A depth of 20 ft bgs was selected for the excavation worker in order to fully encompass maximum depth of burial (see Section 1.3.2). Additional information is provided in Appendix C. The comparison of the EPC and the risk-based concentrations provided an estimate of chemical-specific cancer risk and noncancer hazard and their cumulative estimates. These values are provided in Table 6.1.

**Table 6.1. Estimated Potential ECLRs and HIs Posed to the Industrial Worker and Excavation Worker by COPCs Found in SWMU 4 Soils**

COPC	Industrial Worker		Excavation Worker	
	ELCR	HI	ELCR	HI
<i>Metals</i>				
Arsenic	4.2E-06	< 0.1	2.0E-06	< 0.1
Chromium	< 1E-06	< 0.1	N/A	N/A
Cobalt	N/A	N/A	< 1E-06	< 0.1
Iron	N/A	< 0.1	N/A	< 0.1
Manganese	N/A	< 0.1	N/A	0.1
Mercury	N/A	N/A	N/A	< 0.1
Nickel	N/A	N/A	< 1E-06	< 0.1
Uranium	N/A	< 0.1	N/A	0.8

**Table 6.1. Estimated Potential ECLRs and HIs Posed to the Industrial Worker and Excavation Worker by COPCs Found in SWMU 4 Soils (Continued)**

COPC	Industrial Worker		Excavation Worker	
	ELCR	HI	ELCR	HI
<i>Organics</i>				
Total PAH*	<b>1.9E-05</b>	N/A	<b>5.3E-06</b>	N/A
Total PCBs	<b>1.7E-05</b>	N/A	<b>4.2E-06</b>	N/A
<i>Radionuclides</i>				
Cesium-137	<b>2.4E-06</b>	N/A	<b>2.4E-06</b>	N/A
Neptunium-237	<b>6.8E-06</b>	N/A	<b>4.3E-06</b>	N/A
Plutonium-239/240	N/A	N/A	< 1E-06	N/A
Thorium-230	< 1E-06	N/A	<b>1.3E-06</b>	N/A
Uranium-234	< 1E-06	N/A	<b>5.8E-06</b>	N/A
Uranium-235	<b>3.9E-06</b>	N/A	<b>4.6E-06</b>	N/A
Uranium-238	<b>2.9E-05</b>	N/A	<b>4.6E-05</b>	N/A
<b>Total</b>	<b>8.3E-05</b>	< 1	<b>7.6E-05</b>	<b>1.1</b>

Cancer risks above 1E-06 and noncancer hazards above 1 are shown in bold.

Grayed cells indicated the chemical or radionuclide was not of potential concern for the scenario listed.

\*Maximum detection was used as EPC.

Following this screening, the COPCs listed below showed ELCR > 1E-06 and/or HI > 0.1 (which, if fully evaluated in a BHHRA would indicate a COC).

- Surface Soil COPCs with ELCR > 1E-06 and/or HI > 0.1:

- Arsenic
- Total PAH
- Total PCBs
- Cesium-137
- Neptunium-237
- Uranium-235
- Uranium-238

- Subsurface Soil COPCs:

- Arsenic
- Manganese
- Uranium
- Total PAH
- Total PCBs
- Cesium-137
- Neptunium-237
- Thorium-230
- Uranium-234
- Uranium-235
- Uranium-238

### 6.1.3 Risk Screening for Groundwater COPCs

For exposure to groundwater, the BGOU Work Plan Addendum called for comparison to NALs for the child resident exposure scenario because no NALs for an industrial worker being exposed to groundwater have been established (DOE 2014). Unlike the BGOU RI BHHRA, this BGOU RI Report Addendum compares measured groundwater concentrations, not modeled concentrations. The analytes listed below were detected in the RGA and/or the McNairy and exceed both NAL and background values [RGA and

McNairy background values are reported in the Risk Methods Document, Table A.13, and are taken from the “Over All Observations” values (DOE 2015b)] and, as such, are considered COPCs for groundwater. Additional information regarding the screening of the data is available in Appendix C.

- RGA Groundwater COPCs

- Aluminum
- Arsenic
- Barium
- Beryllium
- Chromium
- Cobalt
- Copper
- Fluoride
- Iron
- Lead
- Manganese
- Mercury
- Nickel
- Selenium
- Vanadium
- Zinc
- 1,1,2-Trichloroethane
- 1,1-Dichloroethane
- 1,1-Dichloroethene
- 1,2-Dichloroethane
- 1,2-Dimethylbenzene
- Benzene
- Carbon tetrachloride
- Chloroform
- *cis*-1,2-Dichloroethene
- Ethylbenzene
- Total Xylene
- *trans*-1,2-Dichloroethene
- Trichloroethene
- Vinyl chloride
- Neptunium-237
- Technetium-99
- Thorium-230
- Uranium-234

- McNairy Groundwater COPCs

- Aluminum
- Arsenic
- Barium
- Beryllium
- Boron
- Cadmium
- Chromium
- Cobalt

- Copper
- Iron
- Lead
- Manganese
- Mercury
- Nickel
- Vanadium
- Zinc
- 1,1-Dichloroethene
- *cis*-1,2-Dichloroethene
- Trichloroethene
- Technetium-99

The locations of the groundwater exceedances are shown on figures in Section 4. Of those exceeding screening levels, aluminum; arsenic; beryllium; cobalt; iron; lead; manganese; vanadium; 1,1,2-TCA; 1,1-DCE; carbon tetrachloride; chloroform; *cis*-1,2-DCE; TCE; and vinyl chloride exceed ALs in RGA groundwater. In the McNairy, aluminum, arsenic, beryllium, cadmium, cobalt, iron, lead, manganese, vanadium, and TCE exceed ALs. Additional information can be found in Section 4.4.

#### **6.1.4 Derivation of Risk Estimates for Groundwater COPCs**

For each COPC for groundwater where there were sufficient results, an EPC was calculated. Three COPCs—1,2-DCA (RGA); uranium-234 (RGA); and boron (McNairy), did not have sufficient results to calculate an EPC, so the maximum detected result was used as the EPC. EPCs for each aquifer were compared to risk-based concentrations to determine an estimate of risk for the child resident scenario and then summed to present a cumulative estimate. These estimates are shown in Table 6.2. Additionally, lead is a COPC in both RGA and McNairy groundwater. Hazards presented by lead are determined independently from the NALs presented in the Risk Methods Document, so they are not presented in the estimates below.

Following this screening, the COPCs listed showed  $ELCR > 1E-06$  and/or  $HI > 0.1$  (which, if fully evaluated in a BHHRA would indicate a COC).

- RGA Groundwater COPCs with  $ELCR > 1E-06$  and/or  $HI > 0.1$ 
  - Aluminum
  - Arsenic
  - Barium
  - Beryllium
  - Cobalt
  - Fluoride
  - Iron
  - Manganese
  - Nickel
  - Vanadium
  - 1,1,2-Trichloroethane
  - 1,1-Dichloroethene
  - 1,2-Dichloroethane
  - Benzene
  - Carbon tetrachloride
  - Chloroform



**Table 6.2. Estimated Potential ECLRs and HIs Posed to the Child Resident by COPCs Found in SWMU 4 Groundwater\***

COPC	RGA		McNairy	
	ELCR	HI	ELCR	HI
<b>Metals</b>				
Aluminum	N/A	<b>2.3</b>	N/A	<b>3.6</b>
Arsenic	<b>2.2E-04</b>	<b>1.9</b>	<b>6.3E-04</b>	<b>5.4</b>
Barium	N/A	0.1	N/A	0.4
Beryllium	N/A	0.3	N/A	<b>1.2</b>
Boron	N/A	N/A	N/A	0.6
Cadmium	N/A	N/A	N/A	<b>2.8</b>
Chromium	N/A	< 0.1	N/A	< 0.1
Cobalt	N/A	<b>11.1</b>	N/A	<b>43.5</b>
Copper	N/A	< 0.1	N/A	0.2
Fluoride	N/A	0.2	N/A	N/A
Iron	N/A	<b>11.6</b>	N/A	<b>100.7</b>
Manganese	N/A	<b>8.5</b>	N/A	<b>19.1</b>
Mercury	N/A	< 0.1	N/A	0.2
Nickel	N/A	0.2	N/A	0.5
Selenium	N/A	< 0.1	N/A	N/A
Vanadium	N/A	<b>4.5</b>	N/A	<b>22.9</b>
Zinc	N/A	< 0.1	N/A	0.2
<b>Organics</b>				
1,1,2-Trichloroethane	<b>5.1E-06</b>	<b>3.4</b>	N/A	N/A
1,1-Dichloroethane	< 1E-06	< 0.1	N/A	N/A
1,1-Dichloroethene	<b>2.3E-05</b>	0.3	<b>1.3E-05</b>	0.2
1,2-Dichloroethane	N/A	0.7	N/A	N/A
1,2-Dimethylbenzene	N/A	< 0.1	N/A	N/A
Benzene	<b>2.8E-06</b>	< 0.1	N/A	N/A
Carbon tetrachloride	<b>4.9E-05</b>	0.5	N/A	N/A
Chloroform	<b>2.1E-04</b>	0.5	N/A	N/A
<i>cis</i> -1,2-Dichloroethene	N/A	<b>6.5</b>	N/A	0.1
Ethylbenzene	<b>2.3E-06</b>	< 0.1	N/A	N/A
Total Xylene	N/A	0.1	N/A	N/A
<i>trans</i> -1,2-Dichloroethene	N/A	< 0.1	N/A	N/A
Trichloroethene	<b>3.9E-03</b>	<b>679.7</b>	<b>1.2E-04</b>	<b>21.1</b>
Vinyl chloride	<b>8.7E-04</b>	0.4	N/A	N/A
<b>Radionuclides</b>				
Neptunium-237	< 1E-06	N/A	N/A	N/A
Technetium-99	<b>5.6E-06</b>	N/A	<b>2.8E-06</b>	N/A
Thorium-230	< 1E-06	N/A	N/A	N/A
Uranium-234	<b>1.3E-05</b>	N/A	N/A	N/A
<b>Total</b>	<b>5.3E-03</b>	<b>732.9</b>	<b>7.6E-04</b>	<b>222.8</b>

Grayed cells indicated the chemical or radionuclide was not of potential concern for the aquifer listed.

Cancer risks above 1E-06 and noncancer hazards above 1 are shown in bold.

Cancer risks above 1E-04 and noncancer hazards above 3 are shown in bold italics.

\*Estimates do not include risks from lead.

- *cis*-1,2-Dichloroethene
  - Ethylbenzene
  - Total Xylene
  - Trichloroethene
  - Vinyl chloride
  - Technetium-99
  - Uranium-234
- McNairy Groundwater COPCs with ELCR > 1E-06 and/or HI > 0.1
    - Aluminum
    - Arsenic
    - Barium
    - Beryllium
    - Boron
    - Cadmium
    - Cobalt
    - Copper
    - Iron
    - Manganese
    - Mercury
    - Nickel
    - Vanadium
    - Zinc
    - 1,1-Dichloroethene
    - *cis*-1,2-Dichloroethene
    - Trichloroethene
    - Technetium-99

### 6.1.5 Risk Screening Uncertainties

Several uncertainties exist within this risk screening, as described within this section. The overall magnitude of these uncertainties is expected to be small.

The XRF data for iron, lead, nickel, and uranium correlated better than other constituents with laboratory data. The weaker correlation creates uncertainty about XRF data for these other constituents. Further, some detection limits for XRF data are above background concentration and NALs, which may suggest incorrectly that metal is present above background levels. XRF detection limits greater than background levels and the discrepancy in correlation may result in an overestimation of risk.

A calculated concentration of Total PAH was used to estimate risk, using toxicity equivalence factors for detected carcinogenic PAHs. Total PAH was not calculated for samples in which no carcinogenic PAHs were detected; therefore, the maximum calculated value was used to estimate risk, not an upper confidence limit. This may result in an overestimation of risk.

The EPC calculated for Tc-99 in groundwater was greater than the maximum value. This may result in an overestimation of risk.

The risk screening does not consider that concentrations of some COCs may be lower or higher in the future because of processes such as degradation and attenuation. The combination of historical data and more recent data for this screening presents an uncertainty.

Additivity of multiple chemicals is assumed. Whether assuming additivity can lead to an underestimation or overestimation of risk is unknown.

## **6.2 BGOU RI BHHRA FOR SWMU 4**

Risks and hazards for soil exposure presented in the BGOU RI BHHRA for SWMU 4 were taken from the previous assessment for WAG 3. For groundwater, the previous assessment was based on measured groundwater concentrations, while the BGOU RI risk assessment used modeled concentrations. Differences can be found in COCs, risk, or hazard level among these previous assessments based on measured concentrations and those resulting from the modeled concentrations presented in this risk assessment. These differences may result from factors such as overestimation by the model or of the source term in the model, or the differences may represent contributions from background or other sources to the measured concentrations in the wells.

### **6.2.1 Identification of COPCs**

Soil COPCs previously were determined in the WAG 3 RI (DOE 1999a). Groundwater COPCs used in the BGOU RI BHHRA were determined from modeled groundwater concentrations derived from soil data. TCE, Tc-99, and uranium isotopes were retained regardless of whether they passed screening levels because they were considered significant risk contributors or known to be part of the facility's process history.

### **6.2.2 Exposure Assessment**

An exposure assessment was used to determine the pathways of exposure that were considered for the surface and subsurface soil and groundwater at SWMU 4 for the BGOU RI. Specifically, the exposure settings of the BGOU are described, the routes of exposure are outlined, and the daily intakes and doses are presented in the BGOU RI Report (DOE 2010a).

Current land use of SWMU 4 is industrial. Under current use, because of access restrictions, only plant workers and authorized visitors are allowed access to the SWMU. As discussed in the PGDP Site Management Plan (DOE 2015a), foreseeable future land use of the area is expected to be industrial as well.

#### **6.2.2.1 Identification of Exposure Pathways**

The following discussions focus on points of potential human contact, types of receptors, and exposure routes that are relevant to exposure to contaminated groundwater and soil evaluated in this and previous BHHRA.

#### **6.2.2.2 Points of Human Contact–Land Use Considerations**

SWMU 4 is located within a large industrial facility; therefore, the current land use is industrial. Industrial land use, as stated in the SAP, necessitates that the current exposure scenario be industrial worker (with exposure to the first ft of surface soil). Additionally, an excavation worker (with potential exposure to soil in the 0-20 ft bgs depth) was used for subsurface soil. The current scenarios do not include any current use of groundwater drawn from the RGA at the sources; therefore, the child resident exposure scenario was used for exposure to groundwater.

The current land use can be expected to continue in the foreseeable future, and the most plausible future land use of the BGOU sites also is industrial. In the future, the expected exposure frequencies and durations may be higher than duration and frequency of the current exposure. Additionally, use of groundwater drawn from the RGA at the BGOU sources is not expected; however, uses of areas surrounding PGDP indicate that it would be prudent to examine a range of land uses to provide decision makers with estimates of the risk that may be posed to humans under alternate uses, however unlikely. The BGOU RI BHHRA reported the hazards and risks for current and several hypothetical future uses, consistent with regulatory guidance and the approved BGOU RI Work Plan (DOE 2006). PGDP is an industrial facility and future land use is expected to remain industrial. The future on-site rural resident is not a likely land use scenario. These factors should be considered in examination of risk information provided in this report. The following future land uses were included in the BHHRA.

- **Future on-site industrial use**—direct contact with surface soil (0 to 1 ft bgs).
- **Future on-site excavation worker**—direct contact with surface and subsurface soil (0 to 10 ft bgs).<sup>3</sup>
- **Future on-site recreational user**—direct contact with surface soils and consumption of game exposed to contaminated surface soil.
- **Future on-site rural resident**—direct contact with surface soil and use of modeled groundwater concentrations from the RGA at source areas, as well as vapor intrusion into a residential basement located above the source.
- **Future off-site rural resident**—use in the home of groundwater drawn from the RGA as well as vapor intrusion into basements at the DOE plant boundary, the DOE property boundary, at Little Bayou seeps (when appropriate) and at the Ohio River.

### 6.2.2.3 Exposure Points and Exposure Routes

Human health risks were assessed in the BGOU BHHRA by determining POEs and exposure routes (Appendix F, DOE 2010a). POEs are locations where human receptors can contact contaminated media. Exposure routes are the processes by which human receptors contact contaminated media. The reasons for selecting or not selecting each exposure route for each of the potentially exposed populations are presented in this BHHRA. The exposure routes that were quantitatively assessed in this and previous BHHRAs are listed below. The exposure routes that were quantitatively assessed in this BHHRA using modeled groundwater are highlighted with an asterisk (\*).

- Ingestion of groundwater as a drinking water source\*
- Inhalation of volatile constituents emitted while using groundwater\*
- Dermal contact with groundwater while showering\*
- Inhalation of vapors released from groundwater into home basements\*
- Vapor intrusion into a basement of a residence\*
- Incidental ingestion of contaminated soil
- Dermal contact with contaminated soil
- Inhalation of particulates emitted from contaminated soil

---

<sup>3</sup> The BGOU RI BHHRA evaluated the excavation worker for direct contact to a depth of 10 ft bgs. This SWMU 4 RI Addendum evaluates the excavation worker for direct contact to a depth of 20 ft bgs (see Section 6.1.2).

- Inhalation of volatile constituents emitted from contaminated soil
- External exposure to ionizing radiation emitted from contaminated soil
- Consumption of game contaminated by consumption of vegetation grown in contaminated soil
- Ingestion of produce

### **6.2.3 Toxicity Assessment**

Toxicity information considered in BHHRA of potential carcinogenic risks includes (1) a weight-of-evidence classification and (2) a slope factor. The weight-of-evidence classification qualitatively describes the likelihood that an agent is a human carcinogen, based on the available data from animal and human studies. The slope factor for chemicals is defined as a plausible upperbound estimate of the probability of a response (i.e., development of cancer) per unit intake of a chemical over a lifetime (EPA 1989). Slope factors are specific for each chemical and route of exposure. Significant changes since the BGOU RI BHHRA have been made to the classification for one of the SWMU 4 COCs. Beryllium no longer is considered cancerous through the oral and dermal pathways.

Toxicity values used in risk calculations also include the chronic reference dose (RfD), which is used to estimate the potential for systemic toxicity or noncarcinogenic risk. The chronic RfD is defined as an estimate of a daily exposure level for the human population, including sensitive subpopulations, that is likely to be without an appreciable risk of deleterious effects during a lifetime (EPA 1989). RfD values also are specific to the chemical and route of exposure.

Dermal contact with soil was a driving exposure route in the previous BHHRA, with most of this risk arising from contact with metals (e.g., beryllium, vanadium). This is a direct result of using dermal absorption factors that exceed gastrointestinal absorption values and may be overly conservative. Since the previous assessment, revisions have been made to the Paducah Risk Methods Document (DOE 2015) and methods presented in EPA's Risk Assessment Guidance Part E have been adopted for use.

### **6.2.4 Risk Characterization**

Risk characterization is the final step in the risk assessment process. Quantitative estimates of both carcinogenic health risks and noncarcinogenic hazard potential from the BGOU RI BHHRA are summarized in Table 6.3. Results from previous risk assessments were used for the soil risk characterization. Risks for residential groundwater use were calculated based on modeled concentrations in the RGA groundwater during the BGOU RI.

#### **6.2.4.1 Risk Characterization of Vapor Intrusion into Basements from Soil**

Characterization of risks from vapor intrusion into residential basements from soil was conducted as part of the BGOU RI risk assessment. To examine potential risks and hazards, vapor intrusion modeling was completed and examined for three POEs: the property boundary, the plant boundary, and at the SWMU.

Modeled concentrations for the on-site POE showed an HQ greater than 0.1 for vapor intrusion from TCE; *cis*-1,2-DCE; and vinyl chloride for SWMU 4. ELCRs for the on-site POE were greater than 1E-06 for SWMU 4 based on modeled contaminant concentrations for TCE and vinyl chloride.

Vapor intrusion into residential basements also was modeled at the plant boundary and property boundary. Both at the plant boundary and the property boundary, all HIs were below 0.1. ELCRs were above 1E-06 at the plant boundary for TCE and vinyl chloride and for TCE at the property boundary.

Characterization of risks and systemic toxicity from vapor intrusion into industrial building basements was conducted as part of the BGOU RI risk assessment. Characterization did not show a potential risk to the future industrial worker to vapors from soil at SWMU 4.

#### **6.2.4.2 Identification of Land Use Scenarios, Pathways, Media and COCs**

In the BGOU RI BHHRA, land use scenarios, exposure pathways, media, and COCs for SWMU 4 were outlined. Results of the WAG 3 risk assessment for SWMU 4 was used for the risk characterization for soil. Section 6.6 of the BGOU RI report (DOE 2010a) presents the remedial goal options (RGOs) for each location and land use scenario.

**Land Use Scenarios of Concern.** To determine whether a land use scenario is of concern, quantitative risk and hazard results were compared to risk and hazard benchmarks for each land use scenario. The benchmarks used for this comparison were a) 1 for HI and b) 1E-06 for ELCR. Land use scenarios with total HIs exceeding the benchmark of 1 are deemed land use scenarios of concern for noncancer hazard. Land use scenarios with a total ELCR exceeding the benchmark of 1E-06 are deemed land use scenarios of concern for cancer risk. These criteria were used in the previous risk assessments for SWMU 4 as well (DOE 2000a). The following are land uses of concern for SWMU 4:

- Industrial
- Excavation
- On-Site Residential
- Off-Site Residential

**Contaminants of Concern (Soil).** To make a determination about whether contaminants are of concern in soil, quantitative risk and hazard results over all pathways from the previous risk assessments for SWMU 4 (DOE 2000a) were compared to risk and hazard benchmarks for land use scenarios of concern. The benchmarks used for this comparison were a) 0.1 for HI and b) 1E-06 for ELCR. Contaminants with chemical-specific HIs or ELCRs exceeding these benchmarks are deemed COCs. A priority COC is a contaminant whose chemical-specific HI is greater than 1 or whose ELCR is greater than 1E-04 for one or more scenarios.

The following were priority COCs found in soil at SWMU 4: barium, beryllium, cadmium, chromium, iron, nickel, uranium, vanadium, Total dioxins/furans, Total PCBs, uranium-234, and uranium-238.

**Contaminants of Concern (Groundwater–Modeled from Soil).** Similarly for groundwater, to determine whether contaminants are of concern, quantitative risk and hazard results over all pathways were compared to risk and hazard benchmarks for land use scenarios of concern. The benchmarks used for this comparison were a) 0.1 for HI and b) 1E-06 for ELCR. Contaminants with chemical-specific HIs or ELCRs exceeding these benchmarks were deemed COCs. Priority COCs are contaminants whose chemical-specific HI is greater than 1 or whose ELCR is greater than 1E-04 for one or more scenarios.

The following presents priority COCs found in groundwater at SWMU 4: arsenic; manganese; *cis*-1,2-DCE; TCE; vinyl chloride; and Tc-99.

#### **6.2.4.3 Pathways of Concern**

To determine whether pathways are of concern, the quantitative risks and hazards for each exposure route are summed over all contaminants and compared to benchmarks for land use scenarios of concern. The benchmarks used for this comparison were (a) 0.1 for HI and (b) 1E-06 for ELCR. For soil, the quantitative risk and hazard results from the previous risk assessment for SWMU 4 was used in the

comparison (DOE 2000a). Exposure routes with HIs and ELCRs exceeding these benchmarks are considered pathways of concern (POCs). These POCs are the following:

- **Results for excess lifetime cancer risk**
  - Current On-site Industrial Worker Exposure to Soil
  - Future On-site Industrial Worker Exposure to Soil
  - Future On-site Excavation Worker Exposure to Soil/Soil and Waste
  - Future On-site Rural Resident Exposure to Soil
  - Future Off-site Rural Exposure to Groundwater (with the POE as the property boundary)
  - Future Off-site Rural Vapor Intrusion (based on preliminary deterministic contaminant transport modeling with the POE as the property boundary)
- **Result for Systemic Toxicity (summarized for the resident):**
  - Current On-site Industrial Worker Exposure to Soil
  - Future On-site Industrial Worker Exposure to Soil
  - Future On-site Excavation Worker Exposure to Soil/Soil and Waste
  - Future On-site Rural Resident Exposure to Soil
  - Exposure to Groundwater
  - Vapor Intrusion (based on preliminary deterministic contaminant transport modeling with the POE as the property boundary)
  - Future Off-site Rural Resident Exposure to Groundwater (with the POE as the property boundary)

#### **6.2.4.4 Media of Concern**

Media of concern are those media that appear in at least one POC. Because they contribute to at least one POC, soil and RGA groundwater are media of concern for SWMU 4.

#### **6.2.4.5 Summary of Risk Characterization**

Table 6.3 presents the summary of the risk characterization from the BGOU RI BHHRA. The summary presents land use scenarios of concern, COCs, and POCs. In addition, the table lists the following:

**Table 6.3. Summary of Risk Characterization from BGOU RI for SWMU 4**

Receptor	Total ELCR <sup>a</sup>	COCs	% Total ELCR	POCs	% Total ELCR	Total HI <sup>a</sup>	COCs	% Total HI	POCs	% Total HI
Current industrial worker at current concentrations (soil) (WAG 3 RI <sup>b</sup> )	5.4E-04	Beryllium Uranium-238	97 2	Dermal External exposure	97 2	3.62E+00	Beryllium Chromium Iron Vanadium Barium	5 45 24 24 2	Dermal	99
Future industrial worker at current concentrations (soil) (WAG 3 RI <sup>b</sup> )	5.4E-04	Beryllium Uranium-238	97 2	Dermal External exposure	97 2	3.62E+00	Beryllium Chromium Iron Vanadium Barium	5 45 24 24 2	Dermal	99
Future child rural resident at current concentrations (soil) (WAG 3 RI <sup>b</sup> )	N/A	N/A	N/A	N/A	N/A	9.82E+01	Barium Beryllium Cadmium Chromium Iron Nickel Vanadium	2 2 2 24 60 2 9	Ingestion Dermal Ingestion of vegetables	1 21 78
Future adult rural resident at current concentrations (soil) (WAG 3 RI <sup>b</sup> )	4.3E-03	Beryllium Total PCB Uranium-234 Uranium-238	72 5 6 17	Dermal External exposure Ingestion of vegetables	36 2 61	2.84E+01	Barium Beryllium Cadmium Chromium Iron Nickel Vanadium	2 2 2 22 63 2 8	Dermal Ingestion of vegetables	14 85
Future child rural resident at current concentrations (RGA groundwater only)	N/A	N/A	N/A	N/A	N/A	5.82E+02	Arsenic Manganese <i>cis</i> -1,2-DCE TCE Vinyl Chloride	1.0 0.2 6.1 92.5 0.2	Ingestion Dermal Inhalation while showering Household inhalation	67.2 20.2 1.4 11.2
Future adult rural resident at current concentrations (RGA groundwater only)	5.41E-02	Arsenic TCE Vinyl chloride Technetium-99	0.9 67.7 30.5 0.9	Ingestion Dermal Inhalation while showering Household inhalation	15.4 36.7 5.4 42.4	1.98E+02	Arsenic Manganese <i>cis</i> -1,2-DCE TCE Vinyl chloride	0.8 0.2 4.1 94.7 0.2	Ingestion Dermal Inhalation while showering Household inhalation	56.5 35.6 0.9 7.0
Future child rural resident at modeled concentrations (RGA groundwater drawn at plant boundary)	N/A	N/A	N/A	N/A	N/A	2.04E+02	Arsenic <i>cis</i> -1,2-DCE TCE Vinyl chloride	0.4 4.6 94.4 0.1	Ingestion Dermal Inhalation while showering Household inhalation	67.5 20.6 1.4 10.6



**Table 6.3. Summary of Risk Characterization for SWMU 4 (Continued)**

Receptor	Total ELCR <sup>a</sup>	COCs	% Total ELCR	POCs	% Total ELCR	Total HI <sup>a</sup>	COCs	% Total HI	POCs	% Total HI
Future adult rural resident at modeled concentrations (RGA groundwater drawn at plant boundary)	2.03E-02	Arsenic TCE Vinyl chloride Technetium-99	0.4 98.0 0.9 0.7	Ingestion Dermal Inhalation while showering Household inhalation	13.6 7.2 5.2 74.0	6.97E+01	Arsenic <i>cis</i> -1,2-DCE TCE	0.4 3.0 96.6	Ingestion Dermal Inhalation while showering Household inhalation	56.5 36.1 0.8 6.6
Future child rural resident at modeled concentrations (RGA groundwater drawn at property boundary)	N/A	N/A	N/A	N/A	N/A	1.03E+02	<i>cis</i> -1,2-DCE TCE Vinyl chloride	4.6 95.3 0.1	Ingestion Dermal Inhalation while showering Household inhalation	67.6 20.8 1.3 10.3
Future adult rural resident at modeled concentrations (RGA groundwater drawn at property boundary)	6.79E-03	TCE Vinyl chloride Technetium-99	97.9 1.1 1.0	Ingestion Dermal Inhalation while showering Household inhalation	19.8 11.0 7.8 61.3	3.51E+01	<i>cis</i> -1,2-DCE TCE	3.1 96.8	Ingestion Dermal Inhalation while showering Household inhalation	56.4 36.3 0.8 6.4
Future child rural resident at modeled concentrations (RGA groundwater drawn at Ohio River)	N/A	N/A	N/A	N/A	N/A	3.33E+01	<i>cis</i> -1,2-DCE TCE	1.7 98.2	Ingestion Dermal Inhalation while showering Household inhalation	74.6 22.9 1.4 1.0
Future adult rural resident at modeled concentrations (RGA groundwater drawn at Ohio River)	2.43E-03	TCE Vinyl chloride Technetium-99	98.2 0.9 0.9	Ingestion Dermal Inhalation while showering Household inhalation	19.6 11.0 7.9 61.5	1.26E+01	<i>cis</i> -1,2-DCE TCE	3.0 96.9	Ingestion Dermal Inhalation while showering Household inhalation	56.4 36.3 0.8 6.4
Future child recreational user at current concentrations (soil) (WAG 3 RI <sup>b</sup> )	N/A	N/A	N/A	N/A	N/A	< 1	*No COCs		*No COCs	
Future teen recreational user at current concentrations (soil) (WAG 3 RI <sup>b</sup> )	N/A	N/A	N/A	N/A	N/A	< 1	*No COCs		*No COCs	
Future adult recreational user at current concentrations (soil) (WAG 3 RI <sup>b</sup> )	< 1.0E-06	*No COCs		*No COCs		< 1	*No COCs		*No COCs	
Future excavation worker at current concentrations (soil and waste) (WAG 3 RI <sup>b</sup> )	2.7E-03	Arsenic Beryllium Total dioxins/furans Total PCB Radium-226 Total uranium <sup>c</sup> Uranium-238	1 7 4 2 2 83 1	Ingestion Dermal External exposure	37 10 54	2.61E+00	Aluminum Arsenic Barium Beryllium Cadmium Chromium Iron Manganese Vanadium	8 4 2 2 1 24 24 14 20	Ingestion Dermal	13 87

Note: N/A = ELCR not applicable to child and teen cohorts. ELCR for adult is for lifetime exposure and takes into account exposure as child and teen.

\*No COCs = There are no COCs or POCs.

<sup>a</sup> Total ELCR and total HI represent total risk or hazard summed across all POCs for all COCs.

<sup>b</sup> Remedial Investigation Report for Waste Area Grouping 3 at the Paducah Gaseous Diffusion Plant, Paducah, Kentucky, DOE/OR/07-1895&D1, September 2000 (DOE 2000a), Table 1.55. In this table, lead has been excluded as a COC.

<sup>c</sup> Risk associated with total uranium at SWMU 4 was calculated using a total uranium analytical result in pCi/g units and toxicity information for U-238. Individual isotopes also were included in the risk calculation, resulting in a double counting of risk due to uranium isotopes. This approach likely accounts for the discrepancy between risk related to total uranium and U-238.

- Receptor risks for each land use scenario of concern,
- Percent contribution by pathway to the total risk, and
- Percent contribution each COC contributes to the total risk.

#### 6.2.4.6 Uncertainty in the Risk Assessment

Risk and hazard estimates could vary if different assumptions were used in deriving the risk estimates or if better information were available for some parameters. No uncertainties were estimated to have a large effect on the risk characterization, and only the following were estimated to have a moderate effect:

- Exclusion of some potential biota (produce and fish) for future receptors,
- Migration of groundwater to off-site receptors,
- Calculation of toxicity values for chemicals (particularly TCE), and
- Updates to toxicity values.

Uncertainty on toxicity factors plays a major role in this risk assessment. Because the RfD for lead was in question even when the previous soil assessments were written, the results were calculated without lead in those previous documents, and those results were summarized in this assessment. At the time the WAG 3 RI reports was developed, beryllium still was evaluated as a carcinogen through the oral route of exposure. Since the completion of those BHHRA, the oral cancer slope factor for beryllium has been withdrawn from IRIS, and there has been an agreement not to use this withdrawn value for risk assessments performed in EPA Region 4. At several SWMUs, beryllium was a significant contributor to the total cancer risk from soil exposure; generally, beryllium accounted for greater than 90% of the risk to the industrial worker and greater than 65% of the risk to the resident, with nearly all the risk due to the oral exposure route. While the inhalation pathway for beryllium exposure is valid, it minutely contributed to the total risk due to beryllium exposure. While beryllium likely may be a COPC, it would be screened from evaluation as a COC because the highest risk from any SWMU was three orders of magnitude less than 1E-06.

When beryllium is removed from consideration as a carcinogen (see Section 6.2.3), the total ELCR becomes much lower at those SWMUs for which it is a COC. The total risk including and excluding the contribution from beryllium is shown below by SWMU and receptor.

<b>Receptor</b>	<b>Risk Including Beryllium</b>	<b>Risk Excluding Beryllium</b>
SWMU 4 Future Industrial Worker	5.4E-04	1.6E-05
SWMU 4 Adult Resident	4.3E-03	1.2E-03

For SWMU 4, removal of the contribution of beryllium to the ELCR reduces the total ELCR to within the EPA risk range of 1E-04 to 1E-06 for the industrial worker scenario.

### 6.2.5 BGOU RI BHHRA Observations and Conclusions

#### 6.2.5.1 Future Industrial Worker

SWMU 4 hazard levels exceed 1 for industrial worker exposure to soil, with chromium, iron, and vanadium serving as the primary hazard drivers for elevated HIs. SWMU 4 exceeds risk levels of 1E-04 for industrial worker exposure to soil, with uranium-235+daughters, uranium-238+daughters, and beryllium serving as the primary risk drivers. Other COCs contributing to elevated risks include Total PAH and arsenic.

### 6.2.5.2 Future Excavation Worker

SWMU 4 exceeds a hazard level of 1 for excavation worker exposure to soil (evaluated for exposure to soil and waste), with aluminum, antimony, chromium, iron, manganese, uranium, and vanadium serving as the primary hazard driver for elevated HIs. Other COCs contributing to hazards include arsenic and copper. SWMU 4 exceeds the risk level of 1E-04 for excavation worker exposure to soil, with beryllium, uranium, Total PAH, and uranium-238 serving as the primary risk drivers. Other COCs contributing to elevated risks include arsenic and uranium-235. SWMU 4 exceeds the risk level of 1E-04 for excavation worker exposure to soil when beryllium is not included in the cumulative ELCR. SWMU 4 included exposure to soil and waste which was included in this BHHRA but referred to as one media type, soil.

### 6.2.5.3 Future On-Site Residents (Groundwater)

For residential groundwater use at the SWMU boundary, ELCR was greater than 1E-04 and HI was greater than 1. The primary risk drivers are TCE, arsenic, vinyl chloride, 1,1-DCE, and Tc-99.

### 6.2.5.4 Future Off-Site Residents (Groundwater)

SWMU 4 exceeds a hazard level of 1 for off-site residential exposure to groundwater at the PGDP plant boundary. SWMU 4 exceeded a hazard level of 1 at the property boundary and at the Ohio River (or seeps). The primary drivers for hazard are arsenic, TCE, *cis*-1,2-DCE, and 1,1-DCE. At the plant boundary, the property boundary, and the Ohio River (or seeps) a risk level of 1E-04 for off-site residential exposure to groundwater was exceeded. The primary risk drivers are TCE, 1,1- DCE, and Tc-99.

## 6.3 REMEDIAL GOAL OPTIONS

RGOs were presented in the BGOU RI for soil for the industrial worker, excavation worker, and residential user scenarios and for the residential groundwater user (DOE 2010a). RGOs were calculated for each COC from the modeled groundwater concentrations considering residential use of groundwater at each source and at the property boundary POE.

## 6.4 SCREENING ECOLOGICAL RISK ASSESSMENT

The BGOU RI provided a summary of the results of the ERA previously completed for SWMU 4 during WAG 3. Table 6.4 lists the chemicals or radionuclides of potential ecological concern (COPECs) at SWMU 4 for further consideration determined from this ERA.

**Table 6.4. COPECs Retained in Surface Soil at SWMU 4 from BGOU RI**

Metals	Rads	Pesticides/PCBs	SVOCs	VOCs
Chromium	---	Total PCBs	---	---
Copper				
Nickel				
Vanadium				
Zinc				

---: no COPECs

Based on the WAG 3 RI report (DOE 2000a)

A revised screening ecological risk assessment (SERA) was completed as part of this BGOU RI Report Addendum (Appendix D). Consistent with the Paducah Ecological Risk Methods Document (DOE 2015c), which incorporates both EPA and Kentucky risk assessment guidance, the SERA was limited to a comparison of maximum concentrations in surface and shallow subsurface soils (0–5 ft bgs) at SWMU 4 against ecological screening levels in order to identify COPECs. The SERA does not consider the limited habitat, SWMU size, or other factors that also need to be considered to characterize ecological risk. The list of COPECs retained from this SERA is provided in Table 6.5.

**Table 6.5. COPECs Retained in Surface and Shallow Subsurface Soil (0–5 ft bgs) at SWMU 4**

Metals	Rads	Pesticides/PCBs	SVOCs	VOCs
Aluminum Arsenic Barium Cadmium Calcium Chromium Copper Iron Lead Manganese Mercury Molybdenum Nickel Potassium Silver Sodium Uranium Vanadium Zinc	Protactinium-234m Thorium-234	Total PCBs	Bis(2-ethylhexyl)phthalate High molecular weight PAHs	---

---: no COPECs

Observations for the SERA are shown in Table 6.6. This table also lists priority COPECs selected from the chemicals at SWMU 4 showing screening HQs greater than 10. “Priority COPECs” are identified in this BGOU RI Report Addendum as an aid to risk managers during decision making.

**Table 6.6. Ecological Screening of SWMU 4**

Description	Area Acres	Ground Cover	Near a Surface Water Body?	Total Screening HI <sup>a</sup>	Priority COPECs	Maximum Detection or 1/2 Maximum Detection Limit (mg/kg) <sup>b</sup>	Soil ESV (mg/kg) <sup>c</sup>	Screening HQ <sup>a</sup>
Burial Area	6.58	Grass	Yes	13035	Aluminum	16300	50	326
					Cadmium	15.6	0.36	43
					Chromium	296	26	11
					Iron	125000	200	625
					Manganese	44700	220	203
					Mercury	10	0.1	100
					Uranium	2840	5	568
					Total PCBs	222	0.02	11100
					High molecular weight PAHs	12.14	1.1	11

<sup>a</sup> The Total Screening HI includes contributions from all of the COPECs (listed in Table D2.2); only priority COPECs [i.e., the COPECs with Screening HQs greater than 10] are shown in this table.

<sup>b</sup> The screening values were selected from the surface and shallow subsurface dataset (0–5 ft bgs). The screening value shown is the maximum detected value.

<sup>c</sup> Ecological screening values (ESVs) are taken from DOE 2015c and Appendix D of this report.

## 7. SUMMARY AND CONCLUSIONS

This chapter summarizes and presents conclusions about the nature and extent of contamination and risk screening at SWMU 4 evaluated for this BGOU RI Report Addendum. The conclusions are drawn from known site conditions, historical knowledge, and environmental sampling data, including historical data and data collected from the BGOU RI addendum investigation.

### 7.1 SUMMARY

In January 2011, EPA, the Commonwealth of Kentucky, and DOE convened a meeting to discuss SWMU 4 project-related data gaps and associated DQOs for the sampling and analysis needed to address those gaps. The SWMU 4 investigation followed the field sampling plan outlined in the BGOU Work Plan Addendum (DOE 2014). The primary goal of this supplemental remedial investigation, consistent with the BGOU Work Plan Addendum, was to address the identified data gaps by further characterization of nature, extent, and magnitude of source zones and secondary sources (such as contaminated soil) at SWMU 4.

As part of the DQO meetings in January 2011, it had been determined that the historical data were sufficient to develop an excavation alternative for all the buried materials and associated contaminated soils at SWMU 4, but it was not sufficient to optimize remedy selection or adequately support remedial design. The BGOU RI addendum investigation for SWMU 4, completed through the implementation of five phases of investigation following completion and approval of the BGOU RI report, was needed to address uncertainties in the residual TCE present in the disposal cells and the underlying soils that may act as a continuing source to groundwater contamination. The data from these five phases were combined with the historical data to form a comprehensive data set for evaluation.

#### 7.1.1 Resolution of SWMU 4 Data Gaps

The identified data gaps related to SWMU 4 are provided below as well as summary and conclusions related to each of the data gaps.

**Data Gap 1:** *There are insufficient data at SWMU 4 to determine whether trichloroethene (TCE) is present in each of the burial cells, and the extent and mass of TCE contamination with sufficient accuracy to effectively and efficiently complete a remedial design for a TCE remedy in the burial cells.*

TCE is not present in each of the burial cells, but was detected sporadically in samples from within the burial cells associated with Burial Cells 1, 4, and 5 (subsurface soil samples collected to 20-ft depth). The maximum TCE concentration within the upper 20 ft, or soil within a burial cell, was 1.5 mg/kg in Burial Cell 1. TCE was not detected in Burial Cell 2 or within the upper 40 ft of subsurface soil at Burial Cell 3. TCE is present primarily in subsurface soil beneath Burial Cell 4. The highest levels of subsurface soil contamination (up to 750 mg/kg) at depths greater than 20 ft are found associated with Burial Cell 4.

**Data Gap 2:** *There are insufficient data at SWMU 4 to determine the extent and mass of TCE contamination with sufficient accuracy to effectively and efficiently complete a remedial design for TCE in the Upper Continental Recharge System (UCRS) (i.e., soils from ground surface to the top of the Regional Gravel Aquifer (RGA) not identified as burial cells).*

Based on the modeled TCE distribution in subsurface soil (at depths from 1 to 60 ft) shown in Figure 4.7, the total mass of TCE in UCRS soil (at concentrations greater than 0.075 mg/kg) is estimated to be

approximately 744 lb (approximately 61 gal of TCE), which is distributed throughout the subsurface. Note that 0.075 mg/kg of TCE is an estimated soil cleanup level based on the cleanup level calculated for TCE sources near the C-720 Building. SWMU 4 cleanup levels will be developed further in the FS. There are two areas in the subsurface with interpreted concentrations greater than 1.0 mg/kg beneath Burial Cell 4 (see Figure 4.6). One of the areas (areal extent of approximately 0.16 acres) is beneath the eastern portion of the cell and the other (areal extent of approximately 0.23 acres) is associated with the western portion of the burial cell. As discussed in Section 4.3, most of the TCE mass occurs in the subsurface between depths of 20 ft and 60 ft bgs. Maximum detected TCE in subsurface soil was 750 mg/kg at a depth of 25 to 30 ft bgs beneath the western portion of Burial Cell 4. Dissolved TCE in UCRS groundwater also provides supporting information that a TCE DNAPL source is likely in the subsurface. There were 10 UCRS groundwater samples, plus a field duplicate, having concentrations greater than one percent effective solubility, or 11,000 µg/L TCE, which is a general criterion used to indicate that DNAPL may be present in the vicinity. The depths of groundwater with TCE concentrations greater than 11,000 µg/L in the UCRS varied from 21 ft to 60 ft bgs and all occurred in the vicinity of Burial Cell 4 (the maximum result in groundwater was detected at the base of the UCRS at a depth of 58 ft).

**Data Gap 3:** *There are insufficient data at SWMU 4 to determine the extent and mass of TCE source term with sufficient accuracy to effectively and efficiently complete a remedial design for source term in the RGA.*

The Southwest Plume SI report (DOE 2007a) and BGOU RI report (DOE 2010a) previously had interpreted a discrete area with TCE concentrations greater than 10,000 µg/L in the RGA immediately downgradient of SWMU 4 as being derived from a potential DNAPL zone in the RGA. The only confirmatory analysis from that report was a single groundwater sample from historic temporary boring DG-030 sampled in August 1999. During this investigation, there were two RGA groundwater samples from temporary borings that had TCE concentrations of 10,000 µg/L or greater. One sample was from the upper RGA (12,000 µg/L at 75 ft depth interval) in boring 004-004P4, and the other was 10,000 µg/L from the 85 ft depth interval in boring 004-005P4 (Figure 4.14 shows the vertical TCE profile of samples collected from the temporary borings in the RGA). With only one RGA groundwater sample slightly exceeding the “one percent effective solubility” criterion of 11,000 µg/L, the elevated TCE concentrations in the RGA likely are the result of a TCE DNAPL in the UCRS rather than a DNAPL source zone within the RGA.

**Data Gap 4:** *There are insufficient data at SWMU 4 to determine with sufficient certainty whether contaminants of concern (COCs) other than TCE in the five primary burial cells represent a migration risk to the RGA or principal threat waste (PTW).*

The SI Report for the Southwest Plume VOC Sources (DOE 2007a) stated that Tc-99 contaminated groundwater exceeding the derived MCL of 900 pCi/L had migrated beyond the SWMU 4 boundary and that SWMU 4 was likely the source. The results of the supplemental investigation at SWMU 4 show that Tc-99 represents a migration risk because it was detected in soils associated with each burial cells at concentrations that exceed soil screening value for protection of UCRS and RGA groundwater (see Tables 4.6, 4.7, 4.8, 4.9, and 4.10 for a comparison against RGA SSLs), and it frequently exceeds the no action value for RGA groundwater (see Table 4.13). Tc-99 was not detected above the derived MCL of 900 pCi/L in any of 288 RGA samples and has been detected above 900 pCi/L in only 3 of 44 samples in the UCRS. The supplemental investigation and prior investigations have not found Tc-99 containing source materials in a significant quantity or high concentrations within the areas sampled. The collected data do not support identifying Tc-99-contaminated material as PTW at SWMU 4.

The results of the investigation confirm the presence of TCE PTW below SWMU 4. Per the BGOU Dispute Resolution Agreement, the FS for SWMU 4 will identify the TCE DNAPL and high

concentration TCE in soils as PTW. The supplemental investigation did identify TCE in UCRS groundwater at concentrations indicative of DNAPL below Burial Cell 4.

The February 2012 *Resolution Agreement of the Formal Dispute* identified certain uranium wastes in SWMU 2 and SWMU 3 as PTW based upon historical disposal records and process knowledge. No uranium source materials such as those described in historical records for SWMU 2 (i.e., uranium shavings and sawdust, and drums of uranyl fluoride solution), and SWMU 3 (i.e., bulk uranium and possible pyrophoric uranium) were observed during the supplemental investigation at SWMU 4; however, potential uranium source materials were identified. These potential uranium source materials include scrap metal, slag, and discolored soil unearthed in Test Pit 5 of Burial Cell 4; some of these materials produced radiological survey readings in excess of 100,000 dpm/100 cm<sup>2</sup> beta/gamma. The soil sample associated with this material contained uranium metal and uranium-238 (U-238) above the excavation worker action levels (see Table A2.2). Uranium concentrations above action levels also were seen in three subsurface samples collected from Burial Cell 4 and one subsurface sample collected from Burial Cell 2. These samples, 4 of over 300 samples collected from across the entire SWMU, represent the only areas in which potential uranium source materials were identified as exceeding the excavation worker action levels in SWMU 4. In Test Pit 4 of Burial Cell 3, approximately one-gal of a green liquid drained from a metal pipe being removed from the pit. The pipe containing the liquid produced radiological survey readings in excess of 100,000 dpm/100cm<sup>2</sup> beta/gamma, but uranium metal and uranium isotopes concentrations did not exceed excavation worker action levels.

Although no “threshold level” of risk has been established by EPA to identify principal threat waste, a general rule of thumb is to consider as a principal threat those source materials with toxicity and mobility characteristics that combine to pose a potential risk several orders of magnitude greater than the risk level that is acceptable for the current or reasonably anticipated future land use, given realistic exposure scenarios. Based upon application of EPA guidance, the potential uranium source materials identified during the supplemental investigation within Burial Cells 2 and 4 do not represent PTW. First, uranium metal is not highly toxic. Second, based upon historical groundwater analyses, neither uranium metal nor uranium isotopes are present in a highly mobile form at SWMU 4. Specifically, uranium metal has never been detected in RGA groundwater at SWMU 4, and uranium isotopes were detected only once. This single detection was in a 1999 sample from MW333 located approximately 100 ft north of SWMU 4. In that instance, the uranium isotope activities were below their respective PGDP-derived MCLs, and subsequent RGA groundwater samples contained no uranium isotopes. However, as stated in Section 4.3 of the SWMU 4 RI Addendum, uranium-234, uranium-235, and uranium-238 isotopes were detected at levels that exceed SSLs for protection of both UCRS and RGA groundwater. Finally, the comparison to risk-based values (see Tables 4.7, 4.9, and A.2.2) indicate that the U-238 concentrations from potential source materials that were collected in Cells 2 and 4 present an excess lifetime cancer risk of between 1E-04 and 1E-03 for the excavation worker. This incremental risk is not several orders of magnitude greater than the 1E-04 risk level that is acceptable for the current or reasonably anticipated future land use and, therefore, is indicative of low-level threat waste. Similarly, the maximum uranium metal concentration from potential source contaminated materials is 11,100 mg/kg, less than one order of magnitude greater than the action level concentration of 2,950 mg/kg for the excavation worker. DOE has collected 179 surface soil samples, 136 subsurface soil samples, and 111 groundwater samples to characterize uranium contamination at SWMU 4. The collected data for SWMU 4 do not indicate the presence of high concentrations or significant quantities of uranium or potential uranium source material.

**Data Gap 5:** *There are insufficient data at SWMU 4 to determine the extent and mass of COCs other than TCE with sufficient accuracy to effectively and efficiently select and design a remedy for the UCRS (i.e., not burial cells or geophysical anomalies).*

The subsurface soil data summary is presented in Section 4.3. Sufficient subsurface soil data, as well as UCRS groundwater data, exist for SWMU 4 to determine the mass and extent of contaminants to effectively and efficiently select and design a remedy for the subsurface soils. A summary of the contaminants found in subsurface soil follows.

Iron, nickel, and uranium are the only metals that exceeded background in more than 10% of the analyses and also exceeded the excavation worker NAL. Iron, which exceeded both background and excavation worker NAL in approximately 10% of the samples, ranged from 3,220 to 87,700 mg/kg. Iron exceeded twice background levels in two samples, both associated with Burial Cell 4. Nickel exceeded background in 13% of the analyses and exceeded twice background in six percent of the analyses. The maximum concentration of nickel, 3,230 mg/kg, was detected in Burial Cell 4 in the 5 to 10-ft depth interval. Uranium was the most commonly detected metal that exceeded both background and risk-based levels. Only uranium was detected above the excavation worker AL of 2,950 mg/kg in four samples. Uranium concentrations ranged up to 11,100 mg/kg. The highest concentrations of uranium were found in Burial Cells 2 and 4, usually in the 5 to 10 ft interval, not in the underlying UCRS.

Total PCBs were detected in subsurface soils above the excavation worker NALs in four percent of the analyses. The maximum detected value was 38 mg/kg of total PCBs in Burial Cell 4, but Burial Cells 1, 2, and 5 also had maximum PCB detections of 10.3, 10.5, and 27 mg/kg, respectively. The highest levels of PCBs all were within the upper 10 ft of the subsurface, not within the underlying UCRS. No SVOCs (as analyzed using laboratory method SW-846-8270) were detected above the excavation worker NALs or ALs in the SWMU 4 subsurface soil.

TCE and several degradation products were the VOCs commonly detected in subsurface soil. TCE was found throughout the vertical profile of the subsurface with highest concentrations in the southern portion of SWMU 4 (closely associated with Burial Cell 4). The range of detected TCE concentrations in subsurface soil ranged up to 750 mg/kg.

Several radionuclides were detected in subsurface soils. Uranium isotopes most commonly exceeded both background and risk-based levels in subsurface soils. Uranium-235 (one sample) and uranium-238 (three samples) also exceeded the excavation worker ALs. The maximum detected activities of the uranium isotopes are found in Burial Cell 4 in the 5 to 10 ft interval. Tc-99 exceeded background in almost 10% of the analyses, with a maximum detectable activity of 1,050 pCi/g. Tc-99 exceeded the UCRS and RGA SSL in all analyses with detections (the detection frequency was 13%). The three highest detections of Tc-99 were in the 5 to 10 ft interval in Burial Cell 4, but there also were sporadic background exceedances throughout the UCRS beneath Burial Cell 1 and Burial Cell 4.

For the current SWMU 4 investigation, more than 30 groundwater samples were collected from seven shallow MWs and direct-push borings. The metals that most commonly exceeded all screening criteria in UCRS groundwater were arsenic, barium, beryllium, cadmium, chromium, and lead.

PCBs were detected in 11 of 16 UCRS analyses. PCBs, with a range of detected values up to 0.422 mg/L, exceeded the MCL of 0.0005 mg/L in 9 samples. Several VOCs exceeded at least one of the UCRS screening criteria, with TCE and associated degradation products being the most common. TCE concentrations in UCRS groundwater ranged up to 197,000 µg/L.

The most common radionuclide detected in UCRS groundwater was Tc-99, with a range of detectable values from 14.5 to 1,640 pCi/L. The maximum Tc-99 in UCRS groundwater was detected in a sample from a depth of 14 to 18 ft within Burial Cell 1. There were two samples collected below Burial Cell 4 with significantly elevated Tc-99 activity concentrations. Most of the UCRS groundwater samples with Tc-99 greater than 100 pCi/L were located along the western side of SWMU 4.



**Data Gap 6:** *There are insufficient data at SWMU 4 to determine the extent and mass of COCs with sufficient accuracy to select and design a remedy for the geophysical anomalies identified in 1999 and 2010 geophysical surveys. Data should be of sufficient quantity and quality to determine whether COCs represent a migration risk to the RGA or PTW.*

The supplemental investigation at SWMU 4 determined the extent and mass of COCs with sufficient accuracy to select and design a remedy for the geophysical anomalies identified in 1999 and 2010 geophysical surveys. The data collected during the supplemental investigation in combination with historical data is of sufficient quantity and quality to determine whether COCs represent a migration risk to the RGA or PTW (migration risk to the RGA and PTW are discussed above in conjunction with Data Gap 4).

**Data Gap 7:** *The depth of the water table at SWMU 4 is uncertain. Specifically, is the buried material at SWMU 4 submerged in water.*

As shown in Figure 3.1 (Section 3.2), the depth to water across SWMU 4 ranges from approximately 1.1 ft to 11 ft bgs, depending on location and season. Test pit excavations and borings revealed that the base of waste ranges from approximately 5 to 20 ft bgs, depending on location. The supplemental investigation determined that much of the buried material at SWMU 4 is submerged in water at least seasonally and probably all of the time for the deeper burial cells.

**Data Gap 8:** *It is uncertain whether the bedding materials surrounding the raw water pipe in the southeastern portion of the SWMU has been impacted by site constituents and act as a preferential pathway for migration outside of the SWMU.*

Phases I and II of the investigation addressed several data gaps including Data Gap 8, and the data were collected in accordance with the approved work plan. Based on the subsurface soil and passive soil gas data collected from Phases I and II of the SWMU 4 investigation, there is no evidence to suggest the bedding materials surrounding the raw water pipe have been impacted by site constituents or that the bedding materials act as a preferential pathway for migration of contaminants outside SWMU 4. Sample locations closer to the pipeline had lower concentrations, or nondetects, compared to those within the cells, and there were no soil gas vapor detections in the samplers deployed near the raw water pipeline.

In addition, the potential for horizontal contaminant migration from the burial pits to the pipeline within the UCRS is small relative to the potential for vertical contaminant migration. The vertical gradient in the UCRS at SWMU 4 is more than an order of magnitude greater than the horizontal gradient. Some lateral movement of contaminants occurs in the UCRS, but these pathways are known to be limited (the lateral dispersion/transport observed in the UCRS occurs as contaminants migrating downward encounter strata with differing properties). Also, based on shallow groundwater level measurements, the observed water levels were below the level of the pipeline for half the year (July 2014 to December 2014).

While there still may be some uncertainty with this data gap, that uncertainty is small based on the data that have been collected and should not preclude the FS from evaluating alternatives for SWMU 4.

**Data Gap 9:** *Hydraulic conductivity of the RGA under SWMU 4, as a measure of groundwater velocity and flow direction, is uncertain.*

Slug tests were performed on the four new RGA MWs at SWMU 4. The results were lower than expected for the RGA (less than 50 ft/day), which may be due to slug tests being extremely sensitive to near-well conditions (e.g., filter pack and well bore); large, in-well storage typical of MWs; and formation damage (skin damage) that is not corrected during well development; however, the hydraulic conductivity values

may be representative for this area of the RGA. The PGDP sitewide groundwater model uses a hydraulic conductivity of 1,046.5 ft/day in the vicinity of SWMU 4, but a nearby aquifer test at C-404 estimated hydraulic conductivity to range from between 53 and 107 ft/day. Based on a range of hydraulic conductivity values and hydraulic gradients (as measured from Figure 3.5), the average RGA groundwater velocity ranges from 0.03 (based on the SWMU 4 average hydraulic conductivity determined from slug tests) to 2.25 ft/day (based on modeled hydraulic conductivity). The average RGA groundwater flow velocity in other areas of the site with contaminant plumes is generally 1 to 3 ft/day. Because the SWMU 4 slug test data provide hydraulic conductivity values in the low range for the RGA, the FS will consider a wider range of uncertainty surrounding hydraulic conductivity to evaluate remedial alternatives adequately.

**Data Gap 10:** *There are insufficient data at SWMU 4 to determine the extent and mass of COCs in the surface soil within the SWMU 4 boundaries.*

The surface soil data summary presented in Section 4.2 and in Table 4.4 provides the nature of the contamination in SWMU 4 surface soils. The horizontal extent of contamination for key metals, PCBs, and radionuclides is provided in Figures 4.1 through 4.3. The metal that most commonly exceeded background (and also exceeded the industrial worker NALs) was uranium. Most of the uranium exceedances were in the southwestern portion of the SWMU, most closely related to Burial Cells 3 and 4. The range of detected results for uranium was 1.39 to 2,840 mg/kg in surface soils (background for uranium is 4.9 mg/kg).

Total PCBs were detected above the industrial worker NALs in 36% of the analyses and above the industrial worker AL in two (less than 1%) of the analyses. The maximum detected value was 222 mg/kg of total PCBs, which also exceeds the excavation worker AL. The two sample locations that exceeded the industrial worker AL were closely grouped in the southwestern portion of SWMU 4 above Burial Cell 4. Total PAH was the only other organic detected above the industrial worker NALs in the SWMU 4 surface soil.

Uranium-238 was the most common radionuclide to exceed background and the industrial worker NAL. Uranium-238 exceeded background in almost 89% of the analyses and also exceeded the industrial worker AL in one location. The range of detected activities of uranium-238 was up to 231 pCi/g. Uranium-238 is broadly distributed across the SWMU, with the maximum detection occurring above the western end of Burial Cell 4.

### **7.1.2 Summary of the Risk Screening Evaluation**

Current land use of SWMU 4 is industrial. Under current use, because of access restrictions, only plant workers and authorized visitors are allowed access to the SWMU. As discussed in the PGDP Site Management Plan (DOE 2015a), foreseeable future land use of the area is expected to be industrial as well.

Consistent with the BGOU Work Plan Addendum, data collected from this sampling effort also has been used to conduct a risk screening for the industrial worker. Risk screening used surface background values and NALs for the industrial worker from the Risk Methods Document (DOE 2015b) for surface soil (0-1 ft bgs), and subsurface background values and excavation worker NALs for the surface and subsurface soil (0–20 ft bgs).

For the SWMU 4, there were 7 COPCs that had an ELCR > 1E-06 or HI > 1 for the future industrial worker scenario exposed to surface soil and 9 COPCs that had an ELCR > 1E-06 and/or HI > 1 for the future excavation worker scenario exposed to surface and subsurface soil. COPCs that exceeded a cancer

risk of 1E-06 or a hazard above 1.0 included arsenic, Total PAH, Total PCBs, cesium-137, neptunium-237, thorium-230, uranium-234, uranium-235, and uranium-238.

For exposure to groundwater, the BGOU Work Plan Addendum called for comparison to NALs for the child resident exposure scenario because no NALs for an industrial worker being exposed to groundwater have been established (DOE 2014). Unlike the BGOU RI BHHRA, this BGOU RI Report Addendum compares measured groundwater concentrations and not modeled concentrations. For groundwater, 17 COPCs in the RGA and 11 COPCs in the McNairy had an ELCR > 1E-06 and/or HI > 1 when compared to the child residential scenario. RGA COPCs with a cancer risk above 1E-06 or hazard above 1.0 include aluminum, arsenic, cobalt, iron, manganese, vanadium, 1,1,2-TCA, 1,1-DCE, benzene, carbon tetrachloride, chloroform, *cis*-1,2-DCE, ethylbenzene, TCE, vinyl chloride, Tc-99, and uranium-234. RGA groundwater contaminants exceeding a cancer risk above 1E-04 or hazard above 3.0 include arsenic, cobalt, iron, manganese, vanadium, 1,1,2-TCA, chloroform, *cis*-1,2-DCE, TCE, and vinyl chloride.

The BGOU RI BHHRA used fate and transport modeling to determine the major contaminants driving the groundwater risks and hazards for SWMU 4. The priority contaminants of concern in groundwater, determined from modeling, were arsenic, manganese, *cis*-1,2-DCE, TCE, vinyl chloride, and Tc-99. While the TCE DNAPL zone at SWMU 4 was not specifically modeled for the BGOU RI BHHRA, it also would have exceeded 1E-04 risk at the property boundary and Ohio River POEs (DOE 2010a).

Table 7.1 shows a summary of estimated potential direct contact risks for SWMU 4 for the appropriate media/scenario, derived using comparisons to NALs.

**Table 7.1. Summary of Estimated Maximum Direct Contact Total ELCR and Total HI for SWMU 4**

Media	Scenario	Direct Contact	
		Total ELCR	Total HI
Surface Soil (0-1 ft bgs)	Industrial Worker	<b>8.3E-05</b>	< 1
Surface and Subsurface Soil (0-20 ft bgs)	Excavation Worker	<b>7.6E-05</b>	<b>1.1</b>
Groundwater (RGA)	Resident (child)	<b>5.3E-03</b>	<b>732.9</b>
Groundwater (McNairy)	Resident (child)	<b>7.6E-04</b>	<b>222.8</b>

**Bold** indicates total HI > 1 or total ELCR > 1E-06; **bold italics** indicates total HI > 3 or total ELCR > 1E-04.

Consistent with the BGOU Work Plan Addendum, a risk screening has been conducted for SWMU 4. Additional information associated with the SWMU 4 BHHRA previously performed as part of the BGOU RI has not been updated.

Consistent with the Paducah Ecological Risk Methods Document (DOE 2015c), which incorporates both EPA and Kentucky risk assessment guidance, a screening ecological risk assessment (SERA) was performed for SWMU 4. The SERA was limited to a comparison of maximum concentrations in the upper five ft of soils at the SWMU against ecological screening levels in order to identify COPECs. The SERA does not consider the limited habitat, SWMU size, or other factors that also need to be considered to characterize ecological risk. The following observations were made for the SERA, as summarized on Table 7.2.

**Table 7.2. Summary of Suite of COPECs Retained in Soil**

Number of Metals	Number of Rads	Number of PCBs	Number of SVOCs	Number of VOCs
19	2	1	2	0

### 7.1.3 Summary of Groundwater Protection Screening

Analytical results from both surface and subsurface soil were screened against screening values for the protection of both UCRS and RGA groundwater. Contaminants that most commonly exceeded both background values and the screening level for the protection of UCRS groundwater include the following: aluminum, arsenic, barium, cadmium, cobalt, copper, iron, lead, manganese, mercury, nickel, selenium, silver, uranium, vanadium, zinc, Total PCBs, naphthalene, 1,1,2-trichloroethane (TCA), 1,1-DCE, 1,2-dimethylbenzene, benzene, carbon tetrachloride, chloroform, *cis*-1,2-DCE, ethylbenzene, m,p-xylene, tetrachloroethene, toluene, total xylene, *trans*-1,2-DCE, TCE, vinyl chloride, cesium-137, neptunium-237, plutonium-239/240, Tc-99, thorium-230, uranium-234, uranium-235, and uranium-238.

Contaminants that most commonly exceeded both background values and the screening level for the protection of RGA groundwater include the following: arsenic, cobalt, iron, manganese, mercury, nickel, silver, and uranium, Total PCBs, naphthalene, 1,2-dimethylbenzene, benzene, carbon tetrachloride, chloroform, *cis*-1,2-DCE, tetrachloroethene, TCE, vinyl chloride, cesium-137, neptunium-237, Tc-99, thorium-230, uranium-234, uranium-235, and uranium-238.

TCE was the most common organic contaminant to exceed the SSL for protection of RGA groundwater with 64 of 404 analyses exceeding the value. Similar to the vertical distribution of TCE, both *cis*-1,2-DCE and vinyl chloride exceeded groundwater protection SSLs from approximately 15 ft to 60 ft bgs. The radionuclides that most commonly exceeded the SSL for protection of RGA groundwater include Tc-99, uranium-234, and uranium-238. Tc-99 exceeded the RGA SSL in all analyses with detections (detection frequency was 13%). The three highest detections of Tc-99 were in the 5 to 10 ft interval in Burial Cell 4, but all burial cells had Tc-99 activity concentrations exceeding both background and the SSL value.

## 7.2 CONCLUSIONS

The BGOU Work Plan Addendum identified data gaps that were necessary to be filled in order to optimize remedy selection in the FS or adequately support remedial design. The BGOU Work Plan Addendum was implemented to reduce the remaining uncertainties from previous investigations regarding the nature and extent of the source zone and secondary sources and to support evaluation of remedial technologies in the FS.

The following are the major findings in the SWMU 4 investigation.

- The investigation has provided data, particularly related to the nature and extent of contamination at SWMU 4, that are sufficient and adequate for proceeding with the FS and subsequent CERCLA documents.
- Environmental media, specifically subsurface soil and groundwater, have been impacted by releases of contaminants from waste. Contamination resulting from the buried waste is found concentrated in the UCRS soils and groundwater immediately within and under the burial cells, with a lesser amount of contamination dispersed laterally from the cells. In addition, activities at SWMU 4 have resulted in contamination of surface soil.
- TCE trends in the UCRS and RGA groundwater indicate that TCE DNAPL is present at SWMU 4 in the subsurface soils of the UCRS. While TCE contamination is found in Burial Cells 1, 4, and 5, the contaminant levels within the upper 20 ft in the burial cells at SWMU 4 do not indicate the presence of a DNAPL source within the burial cells. This indicates the TCE DNAPL source no longer is present within the burial cells or emanating from an isolated point source at the base of the burial cell

(greatest soil concentration of 750 mg/kg TCE was from a sample collected in boring 004-019P3 at a depth interval of 25 to 30 ft beneath Burial Cell 4). Also, the elevated TCE concentrations in the RGA beneath SWMU 4 likely are the result of a TCE DNAPL source in the UCRS rather than a DNAPL source within the RGA.

- The risk screening update indicates that ELCRs greater than 1E-06 and HIs greater than 1 exist for the industrial worker and excavation worker scenarios for surface and subsurface soils, respectively. Arsenic, Total PAH, Total PCBs, cesium-137, neptunium-237, thorium-230, uranium-234, uranium 235, and uranium-238 present the dominant risks from exposure to surface and subsurface soil. The major contaminants presenting groundwater risks (ELCRs greater than 1E-04 or HI greater than 3) in the RGA include arsenic, cobalt, iron, manganese, vanadium, 1,1,2-TCA, chloroform, *cis*-1,2-DCE, TCE, and vinyl chloride.
- Ecological risk screening includes several COPECs. COPECs whose maximum concentration was greater than 10 times their ecological screening value include PCBs, PAHs, and metals (aluminum, cadmium, chromium, iron, manganese, mercury, and uranium).
- Analytical results from both surface and subsurface soil were screened against soil screening values for the protection of both UCRS and RGA groundwater. Contaminants that most commonly exceeded both background values and the screening level for the protection of RGA groundwater include the following: iron, silver, uranium and its isotopes, Total PCBs, TCE, *cis*-1,2-DCE, vinyl chloride, and Tc-99. TCE and its degradation products exceeded the RGA groundwater protection screening values from approximately 15 ft to 60 ft bgs.

### **7.2.1 Data Limitations and Recommendations for Future Work**

The investigation has provided data, particularly related to the nature and extent of contamination at SWMU 4, that are sufficient and adequate for proceeding with the FS and subsequent CERCLA documents.

### **7.2.2 Recommended Remedial Action Objectives**

General cleanup objectives have been developed that serve as guiding principles for creating more detailed RAOs to focus on SWMU-specific problems. A primary objective for the BGOU is to contribute to the protection of off-site residents by addressing sources of groundwater contamination. Based on the current and foreseeable future land use, on-site industrial and excavation workers, recreational users, and off-site residents are the primary human receptors that have the greatest potential for exposure to site contamination originating from PGDP. The primary pathways of exposure are (1) the groundwater pathway for off-site residents; (2) the surface water pathway (i.e., surface water and sediments) for recreational users (assumed to be primarily local residents); and (3) direct contact with waste, soil, and sediment for industrial and excavation workers. The following are the preliminary SWMU 4 RAOs.

- (1) Contribute to the protection of groundwater by eliminating, reducing, or controlling sources of groundwater contamination.
- (2) Prevent exposure to waste and contaminated soils that present an unacceptable risk from direct contact.
- (3) Treat or remove PTW wherever practicable, consistent with 40 *CFR* § 300.430 (a)(iii)(A).

**THIS PAGE INTENTIONALLY LEFT BLANK**

## 8. REFERENCES

- CH2M Hill 1992. *Results of the Site Investigation, Phase II at the Paducah Gaseous Diffusion Plant, Paducah, Kentucky*, KY/SUB/13B-97777C P-03/1991/1, U.S. Department of Energy, Paducah, KY, April.
- Clausen, J. L., K. R. Davis, J. W. Douthitt, and B. E. Phillips 1992. *Report of the Paducah Gaseous Diffusion Plant Groundwater Investigation Phase III*, KY/E-150, Paducah, KY.
- DOE (U.S. Department of Energy) 1997. *Data Summary and Interpretation Report for Interim Remedial Design at Solid Waste Management Unit 2 of Waste Area Group 22 at the Paducah Gaseous Diffusion Plant, Paducah, Kentucky*, DOE/OR/07-1549&D1, U.S. Department of Energy, Paducah, KY, February.
- DOE 1998. *Work Plan for Waste Area Grouping 3 Remedial Investigation/Feasibility Study at the Paducah Gaseous Diffusion Plant, Paducah, Kentucky*, DOE/OR/07-1649&D2, U.S. Department of Energy, Paducah, KY, July.
- DOE 1999a. *Remedial Investigation Report for Waste Area Group 27 at the Paducah Gaseous Diffusion Plant, Paducah, Kentucky*, DOE/OR/07-1777/&D2, U.S. Department of Energy, Paducah, KY, June.
- DOE 1999b. *Remedial Investigation Report for Waste Area Grouping 6 at Paducah Gaseous Diffusion Plant, Paducah, Kentucky*, DOE/OR/07-1727/V1&D2, U.S. Department of Energy, Paducah, KY, May.
- DOE 2000a. *Remedial Investigation Report for Waste Area Grouping 3 at the Paducah Gaseous Diffusion Plant, Paducah, Kentucky*, DOE/OR/07-1895/V1-V4&D1, U.S. Department of Energy, Paducah, KY, September.
- DOE 2000b. *Data Report for the Sitewide Remedial Evaluation for Source Areas Contributing to Off-Site Groundwater Contamination at the Paducah Gaseous Diffusion Plant, Paducah, Kentucky*, DOE/OR/07-1845&D1, U.S. Department of Energy, Paducah, KY, January.
- DOE 2006. *Work Plan for the Burial Grounds Operable Unit Remedial Investigation/Feasibility Study at Paducah Gaseous Diffusion Plant, Paducah, Kentucky*, DOE/OR/07-2179&D2/R1, U.S. Department of Energy, Paducah, KY, August.
- DOE 2007a. *Site Investigation Report for the Southwest Plume at the Paducah Gaseous Diffusion Plant, Paducah, Kentucky*, DOE/OR/07-2180&D2/R1, U.S. Department of Energy, Paducah, KY, June.
- DOE 2007b. *Solid Waste Management Unit 4 Assessment Report for the Paducah Gaseous Diffusion Plant*, DOE/LX/07-0007&D1, U.S. Department of Energy, Paducah, KY, July 19, 2007.
- DOE 2009. *Methods for Conducting Risk Assessments and Risk Evaluations at the Paducah Gaseous Diffusion Plant, Paducah, Kentucky*, DOE/LX/07-0107&D1/V1, Volume 1: Human Health, U.S. Department of Energy, Paducah, KY, July.

- DOE 2010a. *Remedial Investigation Report for the Burial Grounds Operable Unit at the Paducah Gaseous Diffusion Plant, Paducah, Kentucky*, DOE/LX/07-0030&D2/R1, U.S. Department of Energy, Paducah, KY, February.
- DOE 2010b. *Engineering Evaluation/Cost Analysis for the C-747 Burial Yard and C-748-B Burial Area (Solid Waste Management Unit 4) at the Paducah Gaseous Diffusion Plant, Paducah, Kentucky*, DOE/LX/07-0335&D1, U.S. Department of Energy, Paducah, KY.
- DOE 2014. *Addendum to the Work Plan for the Burial Grounds Operable Unit Remedial Investigation/Feasibility Study at the Paducah Gaseous Diffusion Plant, Paducah, Kentucky, Solid Waste Management Unit 4 Sampling and Analysis Plan*, DOE/OR/07-2179&D2/A2/R3, U.S. Department of Energy, Paducah, KY, August.
- DOE 2015a. *Site Management Plan Paducah Gaseous Diffusion Plant, Paducah, Kentucky*. DOE/LX/07-1301&D2/R1, U.S. Department of Energy, Paducah, KY, May.
- DOE 2015b. *Methods for Conducting Risk Assessments and Risk Evaluations at the Paducah Gaseous Diffusion Plant, Paducah, Kentucky*, DOE/LX/07-0107&D2/R5/V1, Volume 1: Human Health, U.S. Department of Energy, Paducah, KY, June.
- DOE 2015c. *Methods for Conducting Risk Assessments and Risk Evaluations at the Paducah Gaseous Diffusion Plant Paducah, Kentucky, Volume 2, Ecological*, DOE/LX/07-0107&D2/R1/V2, U.S. Department of Energy, Paducah, KY, January.
- EPA (U. S. Environmental Protection Agency) 1989. *Risk Assessment Guidance for Superfund, Volume I: Human Health Evaluation Manual, Part A, Baseline Risk Assessment*, OSWER Directive 9285.7-01a, Office of Emergency and Remedial Response, Washington, DC.
- EPA 1994. *DNAPL Site Characterization*, EPA/540/F-94/049, U.S. Environmental Protection Agency, September.
- EPA 1998. *Federal Facility Agreement for the Paducah Gaseous Diffusion Plant*, U.S. Environmental Protection Agency, Atlanta, GA, February 13.
- EPA 2002. EPA Facts About Technetium-99,” July, accessed at <https://semspub.epa.gov/work/11/175252.pdf>.
- Kueper, B. H., and K. L. Davies 2009. *Assessment and Delineation of DNAPL Source Zones at Hazardous Waste Sites*, Groundwater Issue Paper, EPA/600/R-09/119, U.S. Environmental Protection Agency, September.
- Pankow, J. F., and J. A. Cherry 1996. *Dense Chlorinated Solvents and other DNAPLs in Groundwater: History, Behavior, and Remediation*, Waterloo Press.
- PRS (Paducah Remediation Services, LLC) 2010. *2008 Update of the Paducah Gaseous Diffusion Plant Sitewide Groundwater Flow Model*, PRS-ENR-0028, Paducah Remediation Services, LLC, Kevil, KY, February.
- Union Carbide 1973. *The Discard of Scrap Materials by Burial at the Paducah Plant*, Union Carbide Corporation, Paducah, KY, October.



Union Carbide 1978. *The Disposal of Solid Waste at the Paducah Gaseous Diffusion Plant*, Union Carbide Corporation, Paducah, KY, December.

**THIS PAGE INTENTIONALLY LEFT BLANK**

**APPENDIX A**  
**TECHNICAL RECORDS**

**THIS PAGE INTENTIONALLY LEFT BLANK**

# CONTENTS

INTRODUCTION .....	A-5
ATTACHMENT A1: SWMU 4 MONITORING WELL LOGS (CD).....	A1-1
ATTACHMENT A2: SWMU 4 TEST PIT RECORDS (HARD COPY AND CD) .....	A2-1
ATTACHMENT A3: SWMU 4 ENGINEERING AND DESIGN SAMPLES (CD).....	A3-1
ATTACHMENT A4: SWMU 4 BOREHOLE LOGS (CD) .....	A4-1

**THIS PAGE INTENTIONALLY LEFT BLANK**

## **INTRODUCTION**

Appendix A, “Technical Records,” includes information that, due to size or presentation format, is not included in the body of the main text (i.e., Sections 1 through 8). This information is grouped into four categories—monitoring well logs, test pit records, engineering and design samples, and lithological logs. An Attachment for each of these is included in this appendix.

**THIS PAGE INTENTIONALLY LEFT BLANK**



**ATTACHMENT A1**

**SWMU 4 MONITORING WELL LOGS (CD)**

**THIS PAGE INTENTIONALLY LEFT BLANK**

**Attachment A1 is provided on CD (see back cover).**

**THIS PAGE INTENTIONALLY LEFT BLANK**

**ATTACHMENT A2**  
**SWMU 4 TEST PIT RECORDS**

**THIS PAGE INTENTIONALLY LEFT BLANK**

## ANALYTICAL RESULTS FROM SWMU 4 TEST PIT RECORDS

A test pit was excavated in each of the five burial cells, and two test pits were excavated in Burial Cell 4 due to its size and the fact that Burial Cell 4 appears to be associated with the highest volatile organic compound (VOC) concentrations. Test pit locations are shown on Figure A2.1 located at the back of this section. The test pit size was approximately 5-ft wide by 10-ft long. Each test pit reached the base of buried debris (test pit depths ranged from 8 to 25 ft below ground surface (bgs)). Soil samples were taken from the base of each test pit. Water samples were collected from 4 of the 6 test pits; two test pits were dry at the base. In addition to these base-of-pit samples, materials of interest (MOI) encountered prior to reaching the base of some pits were collected at the request of the U.S. Environmental Protection Agency and Kentucky. Some of the guidelines used in collecting these opportunistic samples included these:

- Visual staining;
- Proximity to drums/waste;
- Encountered crushed drums or containers;
- Void spaces with liquids;
- Health and safety monitoring equipments going into “alarm mode”; and
- Unexpected structure of waste material.

A portion of these materials was analyzed in the same manner as the base-of-pit samples. A general description of the MOI is included in Table A2.1 located at the back of this section. Table A2.2, also located at the back of this section, highlights selected contaminants from pit samples that exceed screening levels.

The analytical results of the soil and “soil type” samples collected from the base of each test pit were compared to the same screening levels used for subsurface soil. These screening levels consisted of background soil levels, risk-based no action levels (NALs) and action levels (ALs) for the excavation worker, and groundwater protection site-specific soil screening levels (SSLs) for the Upper Continental Recharge System (UCRS) and Regional Gravel Aquifer (RGA) [dilution attenuation factors (DAFs) of 1 and 58 for the UCRS and RGA, respectively, based on maximum contaminant levels (MCLs), where available].

Water samples collected from the test pits with analytes above detection limits were compared to MCLs, if available. They also were compared to risk-based child resident NALs and ALs.

### **Burial Cell 1**

Test Pit 3 was excavated in the east-central portion of Burial Cell 1, and one soil sample was collected from the pit. Test Pit 3 was excavated to a total depth of 16 ft, and the pit was dry (no accumulated groundwater) when completed. The clay cap was present in Test Pit 3, but it was very thin. Waste was encountered at 4 ft bgs and Test Pit 3 contained scattered construction debris, unidentified metal debris, and drum rings.

The following analytes were detected at concentrations above background screening levels: nickel; selenium; uranium; Total polychlorinated biphenyls (PCBs) (Aroclor 1254); *cis*-1,2-dichloroethene (DCE); toluene; thorium-230; uranium-234; and uranium-238. No analyte that exceeded background exceeded the risk-based NAL or AL values. Of the previous analytes listed, only Aroclor 1254 exceeded the RGA SSL. The result for Aroclor 1254 was 0.009 mg/kg. Iron and manganese also exceeded the RGA

SSL, but the results were less than background. Arsenic exceeded the excavation worker NAL, but the result was less than the background value.

A water sample from Test Pit 3 was analyzed for VOCs only. Contaminants exceeding the MCL included o-xylene, toluene, and vinyl chloride. Contaminants exceeding the child resident NAL included 1,1-DCE, benzene, *cis*-1,2-DCE, trichloroethene (TCE), and vinyl chloride (vinyl chloride, with a concentration of 3.51 µg/L also exceeded the child resident AL). The TCE result was 1.6 µg/L.

### **Burial Cell 2**

Test Pit 2 was excavated in the western portion of Burial Cell 2, and three soil samples were collected from the pit. The test pit reached a maximum depth of 15 ft and had standing groundwater when completed (the top of water was at approximately 14.5 ft bgs). The clay cap was present in Test Pit 2. Waste was encountered at a depth of approximately 2.5 ft bgs. Types of debris found in Test Pit 2 included welding rods, metal roofing, and miscellaneous unidentified metal debris.

The following analytes were detected at concentrations above background screening levels: barium; cadmium; mercury; nickel; uranium; Total PCBs (Aroclor 1248, Aroclor 1254, and Aroclor 1260); cesium-137; neptunium-237; plutonium-239/240; thorium-230; uranium-234; uranium-235; and uranium-238. Analytes exceeding both background and excavation worker NALs include uranium-234, uranium-235, and uranium-238. Analytes exceeding both background and the RGA SSL include PCBs and uranium isotopes. The maximum result for uranium (40.5 mg/kg) was almost nine times background. That sample, which was a field duplicate, had reported isotopic activities of 48 pCi/g for uranium-234, 5.68 pCi/g for uranium-235, and 58.6 pCi/g for uranium-238.

Two water samples plus a duplicate from Test Pit 2 had several constituents that exceeded the MCL and/or the child resident risk screening values. Contaminants exceeding the MCL included the following: arsenic, barium, beryllium, cadmium, chromium, lead, mercury, uranium, Total PCBs, neptunium-237, plutonium-239/240, thorium-230, uranium-234, uranium-235, and uranium-238. Contaminants that exceeded both the child resident NAL and AL included arsenic, cadmium, iron, lead, manganese, nickel, uranium, vanadium, plutonium-239/240, thorium-230, uranium-234, uranium-235, and uranium-238. The only VOCs detected in Test Pit 2 water were low levels (below all screening values) of ethylbenzene and xylenes. Technetium-99 was detected above the child resident NAL, with a maximum activity concentration of 315 pCi/L. Maximum activity concentrations for the uranium isotopes were 7,240 pCi/L for uranium-234, 840 pCi/L for uranium-235, and 8,600 pCi/L for uranium-238.

### **Burial Cell 3**

Test Pit 4 was excavated in the south-central portion of Burial Cell 3, and two soil samples were collected from the pit. The test pit reached a maximum depth of 8 ft and had standing groundwater when completed. The clay cap was present in a layer approximately 3- to 6-inches thick. Waste was encountered at 2 ft bgs, and types of debris found in Test Pit 4 included metal piping and a variety of unidentified scrap metal. In one instance, the piping had enough bulk that the excavation dimensions were altered to dig around the obstruction to reach the base of the waste at 8 ft bgs. During test pit excavation, approximately 1 gal of an unidentified green liquid drained from a metal pipe as it was being removed. Soils that contacted the liquid had radiological survey readings in excess of 100,000 dpm/100 cm<sup>2</sup> beta/gamma.

The following analytes were detected at concentrations above background screening levels: arsenic, beryllium, cadmium, iron, manganese, mercury, nickel, selenium, uranium, vanadium, Total PCBs (Aroclor 1248, Aroclor 1254, and Aroclor 1260), Total PAHs, americium-241, neptunium-237,



plutonium-239/240, technetium-99, thorium-230, uranium-234, uranium-235, and uranium-238. Several of those constituents also exceeded the excavation worker NAL including: arsenic, iron, manganese, uranium, Total PCBs, Total PAHs, neptunium-237, uranium-234, uranium-235, and uranium-238. No constituents exceeded the excavation worker AL. Constituents exceeding both background and the RGA SSL include arsenic, iron, manganese, nickel, PCBs, PAHs, neptunium-237, technetium-99, uranium-234, uranium-235, and uranium-238. The maximum result for technetium-99 was 97.2 pCi/g.

A water sample from Test Pit 4 in Burial Cell 3 had several constituents that exceeded the MCL and/or the child resident risk screening values. Contaminants exceeding the MCL included the following: arsenic, barium, beryllium, cadmium, chromium, lead, mercury, uranium, Total PCBs, americium-241, neptunium-237, plutonium-239/240, technetium-99, thorium-230, uranium-234, uranium-235, and uranium-238. Contaminants exceeding both the child resident NAL and AL included arsenic, cadmium, iron, lead, manganese, mercury, nickel, uranium, vanadium, benzo(a)pyrene, neptunium-237, plutonium-239/240, technetium-99, thorium-230, uranium-234, uranium-235, and uranium-238. No VOCs were detected in the Test Pit 4 water sample. Technetium-99 was detected with an activity concentration of 8,930 pCi/L. Maximum activity concentrations for the uranium isotopes were 11,200 pCi/L for uranium-234, 1,330 pCi/L for uranium-235, and 25,400 pCi/L for uranium-238.

#### **Burial Cell 4**

Test Pits 5 and 6 were excavated in Burial Cell 4 with five soil samples being collected from the two pits. Test Pit 5 was located in the southwestern portion of Burial Cell 4, and Test Pit 6 was located closer to the southeastern portion of the burial cell. The final depth of Test Pits 5 and 6 was 15 ft and 25 ft, respectively. Both test pits contained standing groundwater upon completion (top of water in Test Pit 5 was 14.5 ft bgs, and it was 16 ft bgs in Test Pit 6). There was no evidence of the clay cap in either test pit. Test Pit 5 encountered waste at a depth of 2 ft bgs, and it contained glass bottles, a metal vent hood, smelter molds, drums and drum lids, pipe, and a variety of unidentified metal debris. Waste was encountered at a depth of 2 ft bgs in Test Pit 6, and it contained drums and scattered unidentified metal debris.

The following analytes were detected at concentrations above background screening levels: arsenic, barium, beryllium, cadmium, chromium, iron, lead, manganese, mercury, nickel, selenium, silver, uranium, vanadium, Total PCBs, Total PAHs, benzene, *cis*-1,2-dichloroethene, ethylbenzene, total xylenes, toluene, TCE, vinyl chloride, neptunium-237, plutonium-239/240, technetium-99, thorium-230, uranium-234, uranium-235, and uranium-238. Several of those constituents also exceeded the excavation worker NAL including arsenic, iron, manganese, nickel, uranium, Total PCBs, neptunium-237, thorium-230, uranium-234, uranium-235, uranium-238. Those same constituents, with the exception of neptunium-237 and the addition of several PAHs and technetium-99, exceeded the RGA SSL values. The only detections of TCE in test pit samples were from Test Pits 5 and 6 in Burial Cell 4 with a maximum detection of 0.00284 mg/kg from Test Pit 5. Test pit 5 in the southwestern portion of Burial Cell 4 yielded two results that exceeded the excavation worker AL: uranium with a concentration of 3,580 mg/kg and uranium-238, with an activity concentration of 944 pCi/g.

Two water samples were collected from Test Pit 5, and one sample was collected from Test Pit 6 in Burial Cell 4. Constituents that exceeded the MCL included arsenic, cadmium, lead, mercury, uranium, Total PCBs, *cis*-1,2-DCE, TCE, vinyl chloride, thorium-230, uranium-234, uranium-235, and uranium-238. Contaminants that exceeded both the child resident NAL and AL included arsenic, lead, manganese, uranium, total PCBs, *cis*-1,2-DCE, TCE, vinyl chloride, uranium-234, uranium-235, and uranium-238. The maximum detection of PCBs in the water sample was 43.6 µg/L. The maximum TCE concentration detected was 13.2 µg/L, while the maximum *cis*-1,2-DCE, and vinyl chloride concentrations were 144 µg/L and 66.3 µg/L, respectively. Technetium-99 was detected with a maximum

activity concentration of 428 pCi/L. Maximum activity concentrations for the uranium isotopes were 1,500 pCi/L for uranium-234, 153 pCi/L for uranium-235, and 5,020 pCi/L for uranium-238.

### **Burial Cell 5**

Test Pit 1 was excavated in the southern portion of Burial Cell 5, and one soil sample was collected from the pit. Test Pit 1 was excavated to a depth of 18 ft, and the pit was dry (no accumulated groundwater) when completed. The clay cap was present in Test Pit 1. Waste was encountered at 3 ft bgs. Types of debris found in Test Pit 1 included metal containers, a metal cask, drums in various states of degradation/corrosion, respirator cartridges, and miscellaneous unidentified metal debris.

The following analytes were detected at concentrations above background screening levels: selenium, uranium, total PCBs (Aroclor 1248), phenanthrene, uranium-234, uranium-235, and uranium-238. No analyte exceeded the risk-based NAL or AL values and only Aroclor 1248 exceeded the RGA SSL. The result for Aroclor 1248 was 0.0031 mg/kg. Iron and manganese also exceeded the RGA SSL, but the results were less than background. The result for uranium (22.1 mg/kg) was almost five times background.

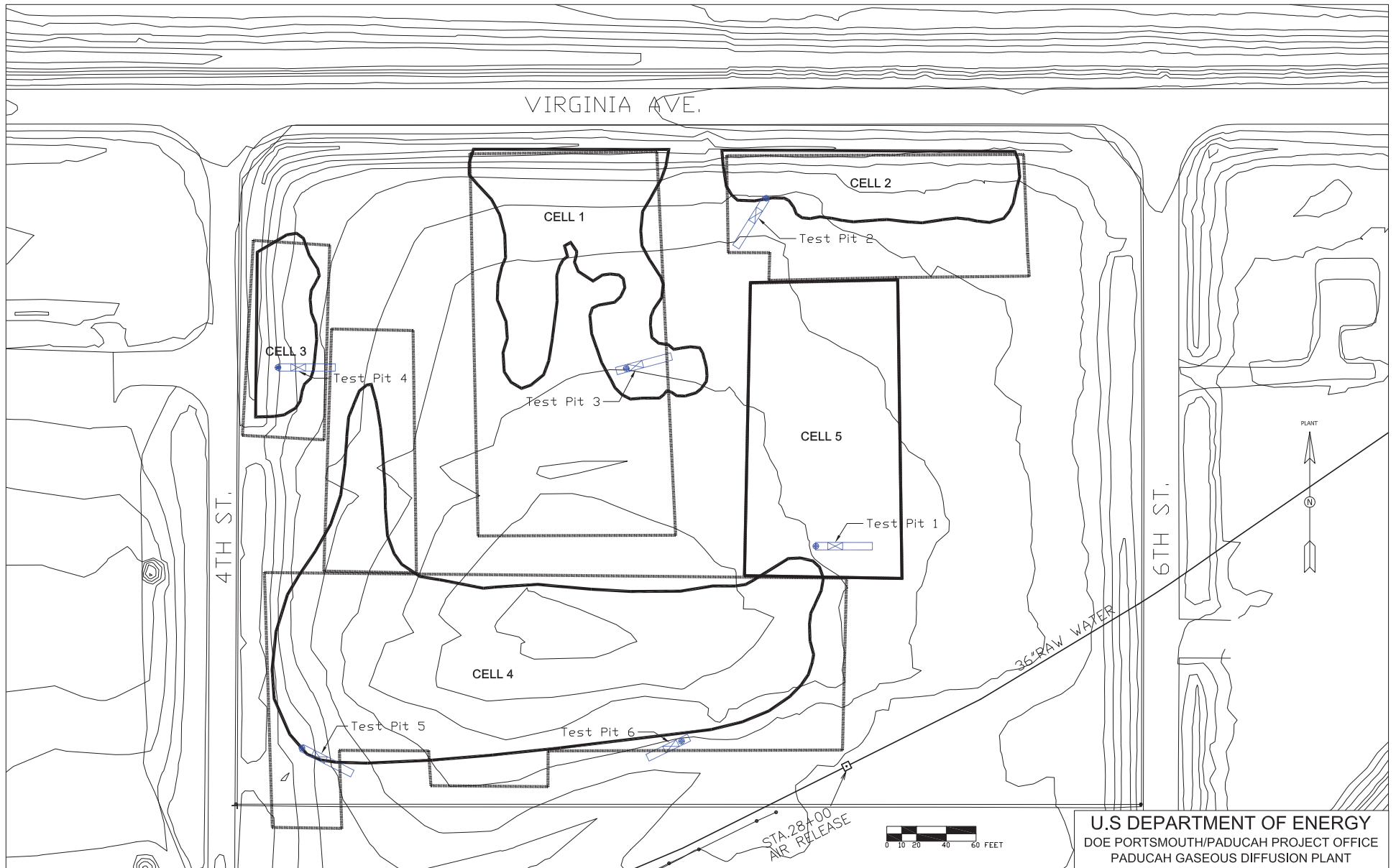

Figure A2.1. SWMU 4 Test Pit Excavation Plan

U.S. DEPARTMENT OF ENERGY  
DOE PORTSMOUTH/PADUCAH PROJECT OFFICE  
PADUCAH GASEOUS DIFFUSION PLANT

**FLUOR** PADUCAH DEACTIVATION PROJECT  
DOE Prime Contract #DE-DT0007774

**THIS PAGE INTENTIONALLY LEFT BLANK**

Table A2.1. Material of Interest (MOI) Collected during Excavations

Material of Interest (MOI) Collected during Excavations								Opportunistic Sample to be Collected?		Base-of-Pit Sample Collected?		
Pit Location	Burial Cell No. and Position within the Cell	KY Representative Present	Collection Date	Depth of Collection (ft bgs)	Matrix	Contained in	General Notes	Preliminary Decision	Rationale	Water	Soil	Depth
1	Southern Cell 5	Brewer	1/28/2016	N/A	N/A	N/A	Pit dug prior to establishment of protocol for opportunistic samples.	N/A	N/A	No (dry)	Yes	18 ft
2	Western Cell 2	None	2/3/2016	6	Water	5-gal plastic bucket	Dark gray colored water.	Yes	This water was collected near the top of the waste and may provide analytical results different than the water collected when the test pit was at its maximum depth.	Yes	Yes	15 ft
2	Western Cell 2	None	2/3/2016	6	Soil	5-gal plastic bucket	Dark gray brownish silty clay.	Yes	This soil was collected near the top of the waste and may provide analytical results different than the water collected when the test pit was at its maximum depth.			
3	Southeastern Cell 1	Brewer	2/1/2016	8	Solid	9 oz wide mouth amber	White material from decayed container. Possibly unused diatomaceous earth filter material.	No	Because there is insufficient volume for RAD analysis and it is assumed to be unused diatomaceous earth, this sample was not selected for lab analysis.	No (dry)	Yes	16 ft
3	Southeastern Cell 1	Brewer	2/1/2016	8	Soil	9 oz wide mouth amber	Brownish silty material transitioning into a light gray clay with some debris.	No	Limited volume will not allow for analysis of all analytical groups- specifically Rads.			
3	Southeastern Cell 1	Brewer	2/1/2016	8	Water	9 oz wide mouth amber	Pit dug prior to establishment of protocol for opportunistic samples. Volume of dark gray water may be inadequate for desired analysis.	Yes	This is the only water sample from test pit 3.			
4	Southern Cell 3	Brock	3/4/2016	2	Solid	5-gal plastic bucket	Green solid material with high rad reading, also 6-inch long pipe. Approximately 1 gallon of unidentified greenish liquid drained from pipe during removal. The pipe containing the liquid had beta/gamma survey readings in excess of 100,000 dpm/100 cm <sup>2</sup> .	Yes	Elevated Rad and unusual green color.	Yes	Yes	8 ft
5	Southwestern Cell 4	None <sup>1</sup>	3/2/2016	6	Water	5-gal plastic bucket	Dark gray water.	Yes	This water was collected near the top of the waste and may provide analytical results different than the water collected deeper as part of the base scope.	Yes	Yes	15 ft
5	Southwestern Cell 4	None <sup>1</sup>	3/2/2016	6	Soil	5-gal plastic bucket	Dark gray brownish silty clay.	Yes	Associated with debris near the top of the test pit and may have a different analytical signature than soil collected deeper as part of the base scope.			
5	Southwestern Cell 4	Brock	3/4/2016	Unknown	Solid	5-gal plastic bucket	Found after the test pit had been refilled as a black silty residual on the surface where the debris had been stockpiled.	Yes	High Rad and dark color.			

Table A2.1. Material of Interest (MOI) Collected during Excavations (Continued)

Material of Interest (MOI) Collected during Excavations								Opportunistic Sample to be Collected?		Base-of-Pit Sample Collected?		
6	Southeastern Cell 4	Brewer	3/8/2016	5 ft–10 ft	Soil	5-gal plastic bucket	Black soil associated with slag-like material.	Yes	Color and association with slag-like material.	Yes	Yes	25 ft
6	Southeastern Cell 4	Brewer	3/8/2016	5 ft–10 ft	Soil	5-gal plastic bucket	This soil, associated with general debris was collected at the request of KDEP (Brewer) because it is a dark gray silty, almost black.	No	Already have one sample from the 5–10 ft zone of test pit 6 being analyzed.			
6	Southeastern Cell 4	Brewer	3/8/2016	23 ft	Sand/Gravel	5-gal plastic bucket	This reddish yellow material was collected at the request of KDEP because it originated at 23 ft bgs, the depth where Phase III DPT refusals occurred.	No	This is not being sampled for analytical purposes because was collect for lithological description only.			
6	Southeastern Cell 4	Brewer	3/8/2016	5–10 ft	Water	5-gal plastic bucket	Dark grayish material that was collected to adhere to the protocol for opportunistic samples.	No	Too similar to scope base scope water sample.			

<sup>1</sup> Brewer and Begley were present for the first attempt to excavate test pit 5 on 2/4/2016.

Inventory of Intact Containers from Excavation							
Pit Location	Burial Cell No. and Position within the Cell	KY Representative Present	Collection Date	Approx. Depth of Collection (ft bgs)	Container Type	Approx. Volume	General Notes
1	Southern Cell 5	None	1/29/2016	5–8 ft	Metal Cask	25 gal	Upon removal from the pit, this container appeared to be sealed; therefore, as a best management practice, container was not reburied immediately so that it could be opened and its contents analyzed. Later, closer inspection revealed the container was breached. Therefore, after taking radiological wipe samples (see Figure A2.2 for the Radiological Survey Contamination Form), it was reburied in Test Pit 1.
5	Southwestern Cell 4	None	3/2/2016	2 ft–15 ft	Amber Glass wide mouth	1 pint	Upon removal from the pit, this container appeared to be sealed; therefore, as a best management practice, container was not reburied immediately so that it could be opened and its contents analyzed. Later, closer inspection revealed the container was empty; therefore, it was reburied in Test Pit 5.
5	Southwestern Cell 4	None	3/2/2016	2–15 ft	Amber Glass wide mouth	1 pint	Upon removal from the pit, this container appeared to be sealed; therefore, as a best management practice, the container was not reburied immediately so that it could be opened and its contents analyzed. Later, as a result of operational miscommunication, field workers included this container with other material being reburied in Test Pit 5. Prior to placing the container in the excavator bucket, it was uncapped and the contents (approximately 8 fluid ounces of an unknown liquid) was decanted into the excavator bucket. The worker did not notice anything unusual about the liquid (odor, reaction, etc.); however, did note a gray viscous residual material came out with the liquid.
5	Southwestern Cell 4	None	3/2/2016	2 ft–15 ft	Clear Glass	2 liters	Upon removal from the pit, this container appeared to be sealed; therefore, as a best management practice, the container was not reburied immediately so that it could be opened and its contents analyzed. Later, as a result of operational miscommunication, field workers included this container with other material being reburied in Test Pit 5. Prior to placing the container in the excavator bucket the it was uncapped and the contents (estimated at less than 4 fluid ounces of an unknown liquid) was decanted into the excavator bucket. The worker did not notice anything unusual about the liquid (odor, reaction, etc.).

RADIOLOGICAL SURVEY CONTAMINATION FORM

Survey Number: 16-FPDP-ERWM-0359-S

Page 2 of 2

Instrument	1		1		3		3		1		3		Sample Location and/or remarks	RCT Initials
	Total α		Removable α		Total β/γ		Removable β/γ		Removable α		Removable β/γ			
	dpm/100cm <sup>2</sup>		dpm/100cm <sup>2</sup>		dpm/100cm <sup>2</sup>		dpm/100cm <sup>2</sup>		cpm/LAW		cpm/LAW			
	bkg(cpm)	CF:	bkg(cpm)	CF:	bkg(cpm)	CF:	bkg(cpm)	CF:	bkg(cpm)	CF:	bkg(cpm)	CF:		
	2	4.44	2	7.21	89	28.43	89	89	N/A	N/A	N/A	N/A		
	5		5		11		11							
Item No.	gross cpm	dpm 100cm <sup>2</sup>	gross cpm	dpm 100cm <sup>2</sup>	gross cpm	dpm 100cm <sup>2</sup>	gross cpm	dpm 100cm <sup>2</sup>	LAW α cpm/LAW	LAW β/γ cpm/LAW				
1	N/A	N/A	4	<Lc	N/A	N/A	101	<Lc	N/A	N/A	Pre-job on Excavator Floor		RPM/TM	
2	N/A	N/A	4	<Lc	N/A	N/A	95	<Lc			Seat			
3	N/A	N/A	4	<Lc	N/A	N/A	91	<Lc			Control Panel			
4	2	<Lc	2	<Lc	73	<Lc	80	<Lc			Hose for breathing air			
5	3	<Lc	2	<Lc	81	<Lc	79	<Lc			Air bracket holder			
6*	0	<Lc	1	<Lc	321	642	65	<Lc			Cask I/S			
7*	2	<Lc	3	<Lc	355	766	88	<Lc			Cask I/S			
8*	5	28	6	29	391	8586	86	<Lc			Cask O/S			
9*	4	<Lc	3	<Lc	388	8501	89	<Lc			Cask O/S			
10-17	3	<Lc	4	<Lc	99	<Lc	93	<Lc			Mud mats (8)			
18	1	<Lc	2	<Lc	81	<Lc	79	<Lc			Radio		RPM/TM	
<p style="font-size: 2em; opacity: 0.5;">N/A</p>														
N/A	N/A	N/A	N/A	N/A	N/A	N/A	N/A	N/A	N/A	N/A	N/A	N/A	N/A	N/A

Comments

Highest readings are recording N/A

NOTE: Any response of the instrument that is ≥ Lc is considered to be above background. Review the Identified Source Document for This Form Prior to Attempting Completion. Complete All Forms in Accordance with CP2-OP-0207

Figure A2.2. Radiological Survey Contamination Form

A2-11

**THIS PAGE INTENTIONALLY LEFT BLANK**



**Table A2.2. Test Pits and Selected Contaminants  
Detected above Screening Levels in SWMU 4**

	Cell 5				Cell 2				Cell 1				Cell 3				Cell 4							
	004-TP1				004-TP2				004-TP3				004-TP4				004-TP5				004-TP6			
Analysis	Soil	Ground water	MOI Soil	MOI Ground water	Soil	Ground water	MOI Soil	MOI Ground water	Soil	Ground water	MOI Soil	MOI Ground water	Soil	Ground water	MOI Soil	MOI Ground water	Soil	Ground water	MOI Soil	MOI Ground water	Soil	Ground water	MOI Soil	MOI Ground water
<i>Metals (mg/kg for Soil and mg/L for Groundwater)</i>																								
Arsenic	1.63	N/A	N/A	N/A	1.41	0.0516	1.9	0.00569	3.75	N/A	N/A	N/A	23.6	0.131	15.8	N/A	12	0.00795	18.2	0.0151	1.66	0.00702	3.16	N/A
Barium	61.8	N/A	N/A	N/A	59.5	3.18	236	0.235	152	N/A	N/A	N/A	115	5.35	147	N/A	138	0.277	120	0.24	62	0.333	231	N/A
Beryllium	0.505	N/A	N/A	N/A	0.498	0.0141	0.631	0.000242	0.57	N/A	N/A	N/A	1.52	0.0163	0.975	N/A	0.841	0.000744	0.95	0.00112	0.592	0.000766	0.649	N/A
Cadmium	0.176	N/A	N/A	N/A	0.167	0.076	0.287	0.00152	0.21	N/A	N/A	N/A	0.233	0.142	0.659	N/A	1.63	0.006	1.77	0.00671	0.0836	0.000419	1.84	N/A
Chromium	16.3	N/A	N/A	N/A	15.4	0.676	19.5	0.00432	19.5	N/A	N/A	N/A	40.2	1.35	29.2	N/A	47	0.0338	40.1	0.0634	16	0.0154	50.9	N/A
Iron	10700	N/A	N/A	N/A	14700	466	13600	2.68	19400	N/A	N/A	N/A	50700	964	35400	N/A	33100	13.1	32800	28.3	9750	10.6	22700	N/A
Lead	9.51	N/A	N/A	N/A	10	0.802	9.9	0.00778	12	N/A	N/A	N/A	19.6	1.23	21.3	N/A	33.6	0.0336	104	0.115	7.6	0.0103	46.7	N/A
Manganese	161	N/A	N/A	N/A	71.6	4.61	205	0.114	237	N/A	N/A	N/A	929	21	1260	N/A	939	1.46	661	2.15	71.8	0.829	264	N/A
Mercury	0.0113	N/A	N/A	N/A	0.169	0.0144	0.0396	0.000437	0.0333	N/A	N/A	N/A	0.1	0.0272	0.249	N/A	1	0.00286	0.795	0.00274	0.0252	0.000231	0.264	N/A
Nickel	15.7	N/A	N/A	N/A	22.7	5.65	29	0.0821	36.1	N/A	N/A	N/A	78.7	64.6	280	N/A	1370	0.394	663	0.947	10.6	0.118	495	N/A
Selenium	1.71	N/A	N/A	N/A	0.633	0.00939	ND	ND	1.01	N/A	N/A	N/A	1.42	0.031	0.486	N/A	0.893	ND	0.414	ND	0.875	0.0016	ND	N/A
Silver	0.305	N/A	N/A	N/A	0.268	0.0206	0.237	ND	0.366	N/A	N/A	N/A	0.646	0.0193	ND	N/A	2.81	0.00235	1.43	0.0021	ND	0.000209	1.52	N/A
Uranium	22.1	N/A	N/A	N/A	40.5	16.2	36.6	1.11	19.6	N/A	N/A	N/A	356	62.3	599	N/A	3580	9.04	2840	19.5	11.7	13	2640	N/A
Vanadium	29.3	N/A	N/A	N/A	32.5	0.666	34.2	ND	31.9	N/A	N/A	N/A	56.8	0.662	45	N/A	46.6	0.0262	52.4	0.0358	27.8	0.0252	34	N/A
<i>PCBs (mg/kg for Soil and mg/L for Groundwater)</i>																								
PCBs, Total	0.00311	N/A	N/A	N/A	0.465	0.00289	0.0767	0.000354	0.00897	N/A	N/A	N/A	1.32	0.00402	1.82	N/A	5.76	0.0436	23.1	0.0281	0.0769	0.00162	3.62	N/A
<i>SVOAs (mg/kg for Soil and mg/L for Groundwater)</i>																								
Total PAH	ND	N/A	N/A	N/A	ND	ND	ND	ND	ND	N/A	N/A	N/A	0.593974	ND	0.020896	N/A	0.015433	ND	0.022355	ND	ND	ND	0.048135	N/A
<i>VOAs (mg/kg for Soil and mg/L for Groundwater)</i>																								
TCE	ND	N/A	N/A	N/A	ND	ND	ND	ND	ND	N/A	N/A	0.0016	ND	ND	ND	N/A	0.00272	0.00077	0.00284	0.00063	ND	0.0132	0.00233	N/A
<i>Radionuclides (pCi/g for Soil and mg/L for Groundwater)</i>																								
Americium-241	ND	N/A	N/A	N/A	ND	8.06	ND	ND	ND	N/A	N/A	N/A	0.131	26.8	0.171	N/A	0.393	ND	0.184	ND	ND	ND	ND	N/A
Cesium-137	ND	N/A	N/A	N/A	0.678	147	0.232	ND	ND	N/A	N/A	N/A	0.0753	26	0.243	N/A	0.124	ND	0.166	ND	ND	ND	0.0916	N/A
Neptunium-237	ND	N/A	N/A	N/A	0.317	28.9	0.221	1.26	ND	N/A	N/A	N/A	3.79	982	7.67	N/A	2.81	ND	1.96	2.34	ND	ND	0.516	N/A
Plutonium-239/240	ND	N/A	N/A	N/A	0.314	55.3	ND	ND	ND	N/A	N/A	N/A	0.928	192	1.31	N/A	1.59	1.58	1.38	2.42	ND	ND	0.38	N/A
Technetium-99	ND	N/A	N/A	N/A	ND	315	ND	30.1	ND	N/A	N/A	N/A	97.2	8930	17.6	N/A	100	112	49.8	438	ND	84	ND	N/A
Thorium-230	1.01	N/A	N/A	N/A	3.2	79.3	1.37	ND	1.77	N/A	N/A	N/A	18.9	1620	9.02	N/A	33	15.6	49.2	22.1	1.13	6.84	9.04	N/A
Uranium-234	1.6	N/A	N/A	N/A	48	7240	19.6	279	1.66	N/A	N/A	N/A	61.5	11200	119	N/A	189	528	263	1330	11.5	1500	102	N/A
Uranium-235	0.0792	N/A	N/A	N/A	5.68	840	1.01	21.2	ND	N/A	N/A	N/A	5.16	1330	10.5	N/A	16.6	31.8	34.8	153	0.77	121	7.65	N/A
Uranium-238	2.32	N/A	N/A	N/A	58.6	8600	25.1	374	2.01	N/A	N/A	N/A	151	25400	334	N/A	726	2340	944	5020	18.1	3600	203	N/A

Maximum value shown for each test pit.  
 "ND" indicates result was not detected.  
 "N/A" indicates sample was not collected.

Cell color coding for Soils:

- Green indicates result is greater than excavation worker NAL (not greater than background).
- Orange indicates result is greater than background value (not greater than excavation worker NAL).
- Brown indicates result is greater than both excavation worker NAL and background values.
- Red indicates result is greater than excavation worker AL and background values.
- Blue indicates result is greater than RGA SSL.

(NOTE: Cell is color coded for exceeding RGA SSL only if result does not exceed NAL or background value.)

Cell color coding for Groundwater:

- Green indicates result is greater than child resident NAL.
- Blue indicates result is greater than MCL.
- Purple indicates result is greater than both child resident NAL and MCL.

**THIS PAGE INTENTIONALLY LEFT BLANK**

**ATTACHMENT A3**

**SWMU 4 ENGINEERING AND DESIGN SAMPLES (CD)  
(SLUG TEST, PERCOLATION TEST, GRAIN SIZE,  
AIR PERMEABILITY, AND PASSIVE SOIL GAS RESULTS)**

**THIS PAGE INTENTIONALLY LEFT BLANK**

**Attachment A3 is provided on CD (see back cover).**

**THIS PAGE INTENTIONALLY LEFT BLANK**

## **ATTACHMENT A4**

### **SWMU 4 BOREHOLE LOGS (CD)**

**(Note: Standard Penetration Test information is recorded in the logs for MW549 and MW551. Recovery footage may be more or less than the footage drilled/pushed because of sample expansion or incomplete sample recovery.)**

**THIS PAGE INTENTIONALLY LEFT BLANK**



**Attachment A4 is provided on CD (see back cover).**

**THIS PAGE INTENTIONALLY LEFT BLANK**

**APPENDIX B**

**ANALYTICAL DATA AND QUALITY ASSURANCE/QUALITY  
CONTROL EVALUATION RESULTS**

**THIS PAGE INTENTIONALLY LEFT BLANK**

# CONTENTS

TABLES .....	B-5
ACRONYMS .....	B-7
B.1. RI ADDENDUM LABORATORY ANALYTICAL DATA .....	B-9
B.2. FIELD RESULTS .....	B-9
B.2.1 XRF .....	B-10
B.2.1.1 Initial Comparison .....	B-10
B.2.1.2 Graphical Comparison of Paired Samples Based Upon Analytical Method .....	B-10
B.2.1.3 Summary of Frequencies of Detection of Analytes and False Positive/Negative Results .....	B-11
B.2.1.4 Summary .....	B-12
B.2.2 PCBS .....	B-14
B.3. REFERENCES .....	B-14
ANALYTICAL DATA (CD) AND ATTACHMENT XRF STATISTICS (CD) .....	B-17

**THIS PAGE INTENTIONALLY LEFT BLANK**

## TABLES

B.1. Ranges of XRF Results .....	B-10
B.2. Summary of Initial Observations by Analyte.....	B-11
B.3. Summary of Frequencies of False Positive and False Negative Results in Field Data.....	B-12
B.4. DQA Findings for Use of XRF Data.....	B-13
B.5. Ranges of PCB Test Kit Results .....	B-14

**THIS PAGE INTENTIONALLY LEFT BLANK**



## ACRONYMS

BGOU	Burial Grounds Operable Unit
COPC	chemical or radionuclide of potential concern
DOE	U.S. Department of Energy
DQA	data quality analysis
EPA	U.S. Environmental Protection Agency
PGDP	Paducah Gaseous Diffusion Plant
RI	remedial investigation
SAP	sampling and analysis plan
SWMU	solid waste management unit
XRF	X-ray fluorescence

**THIS PAGE INTENTIONALLY LEFT BLANK**

Several investigations have been conducted over the past 20 years at the Paducah Gaseous Diffusion Plant (PGDP) that have provided soil data that may be considered in drawing conclusions for Solid Waste Management Unit (SWMU) 4 of the Burial Grounds Operable Unit (BGOU). The most recent sampling and analysis strategy was implemented according to the agreed upon protocols to address data gaps identified in the SWMU 4 Sampling and Analysis Plan (SAP) (DOE 2014). These data were collected to supplement the historical information, providing a robust data set representative of the soils at the SWMU.

The SAP was implemented to optimize remedy selection by filling data gaps that were jointly identified by U.S. Department of Energy (DOE), U.S. Environmental Protection Agency (EPA), and the Kentucky Department for Environmental Protection. The SAP contains a Quality Assurance Project Plan that was updated throughout the project. This section provides a review of the overall data set to determine potential data quality issues that limit the uses of some of these data to support decisions at these sites. The SAP provided for collection of laboratory analytical data with field data that included results from X-ray fluorescence (XRF) and polychlorinated biphenyl (PCB) field test kits. Historical data to support the BGOU remedial investigation (RI) were evaluated during development of the original BGOU work plan (DOE 2006) relative to the data quality objectives.

The dataset used to evaluate SWMU 4, both historical data and data collected for this RI addendum, are included on compact disc found at the end of this appendix.

## **B.1. RI ADDENDUM LABORATORY ANALYTICAL DATA**

Data were validated and assessed following DOE contractor procedures. There were no analytical data that were considered unusable for the RI.

## **B.2. FIELD RESULTS**

Field laboratory data such as XRF data and results from PCB field test kits are available in addition to the laboratory analytical data. The primary use of such data is for site characterization, but these survey-type data also can play a role in risk-based decision making. Survey-type data assist in determining distribution of chemicals or radionuclides of potential concern (COPCs) and can be used to identify which sets of laboratory data should be combined to develop site average contaminant concentrations. Consistent with previous projects at the site, survey-type data also could be combined with laboratory data in a risk assessment to determine the average concentrations for contaminants, but this would require demonstrating that the laboratory and survey-type data possess similar detection limits and analytical uncertainty, and data sets are comparable and representative of the site conditions. This is the one focus of the considerations in determining the usability of these results.

Per EPA data usability guidance (EPA 1992), the analytical data objective for baseline risk assessment is that uncertainty is known and acceptable, not that uncertainty should be reduced to a particular level. In addition, because sampling variability typically contributes much more to total error than analytical variability, the use of a larger number of field method results to characterize the site may provide a better estimate of the average concentration, provided these data are defensible.

The following discussions consider whether the detection limits are sufficiently low to distinguish from background or risk-based concentrations, detected concentration ranges and ability to use to identify “hot

spots” (values above action levels), potential for false negatives that could result in underestimating risks, and comparison of field results with confirmatory samples.

### B.2.1 XRF

XRF data were evaluated in multiple stages. The initial comparison of XRF and fixed-base laboratory data includes correlation and graphical comparison between paired data (i.e., composite split samples with both XRF and fixed-base results). The second stage of comparison includes false negative/false positive comparison (assuming fixed-base laboratory data represent the soil sample concentration).

A summary of the XRF data collected for this RI Addendum is presented in Table B.1.

**Table B.1. Ranges of XRF Results**

Analysis	Units	ALL XRF DATA		PAIRED XRF DATA	
		Min	Max	Min	Max
Arsenic	mg/kg	1	17.9	1	7.9
Barium	mg/kg	10	489	10	462
Cadmium	mg/kg	6	6	6	6
Chromium	mg/kg	5	87	5	80
Iron	mg/kg	4,234	17,878	4,234	15,620
Lead	mg/kg	6.8	61	6.8	28.5
Manganese	mg/kg	88	2,325	88	389
Mercury	mg/kg	2	10	2	8
Nickel	mg/kg	10	182	10	103
Selenium	mg/kg	1	1	1	1
Silver	mg/kg	6	37	6	37
Uranium	mg/kg	20	2,323	20	1,109

#### B.2.1.1 Initial Comparison

Data collected from the SWMU 4 SAP Phase 1 sampling to evaluate the nature and extent of metals in surface soils yielded approximately 17 laboratory analyses that were supplemented with approximately 162 field analyses using XRF. As expected, the XRF data correlated better with the laboratory data for many constituents, but not all constituents (Johnson 2008). This discrepancy provides an uncertainty that is documented in this data quality analysis (DQA) and will be addressed in Section 6 of this RI Addendum to support remedial decision making. The attachment to this DQA provides additional statistics for the XRF data.

#### B.2.1.2 Graphical Comparison of Paired Samples Based Upon Analytical Method

The results for approximately 17 soil samples analyzed by cup XRF and laboratory methods were assessed graphically. These pairs were sorted graphically by increasing XRF and laboratory result and by sample number. In general, it appears that XRF results have higher detection limits and higher reported values than the laboratory results. There are exceptions to this generalization and other factors such as laboratory dissolution methods may contribute to the higher reported values for the XRF. Thus, using the higher value (typically the XRF value) in a risk assessment typically will overstate the risk/hazard (hereafter referred to as risk).

The graphs for comparison are presented in the attachment to this appendix along with the additional statistics. The graphs illustrate the differences in results for the samples in which both an XRF and a

fixed-base laboratory result were obtained. The graphs illustrate the results obtained by the two different methods (on the same sample), sorted by increasing XRF result. Each graph also shows the XRF reporting limits and the background values (DOE 2015). Table B.2 lists observations from the initial review of the data.

**Table B.2. Summary of Initial Observations by Analyte**

Analyte	Correlation*	Notes
Arsenic	0.149	Most values below background
Barium	-0.15	XRF results mostly >background; lab results mostly < background
Cadmium	not defined	No XRF detections; laboratory results < XRF reporting limit
Chromium	-0.21	XRF results mostly >background; lab results mostly ~equal to or below background
Iron	0.003	Most results below background for both methods
Lead	0.444	Somewhat good correlation
Manganese	0.465	Somewhat good correlation
Mercury	-0.1	Only one XRF detection; laboratory results < XRF reporting limit
Nickel	0.772	Good correlation
Selenium	not defined	No XRF detections; no laboratory detections
Silver	0.063	Few XRF detections; no laboratory detections
Uranium	0.832	Good correlation

\*Pearson correlation coefficient for sample pairs.

Note: Additional information regarding XRF performance by analyte at PGDP can be found in Johnson 2008.

#### **B.2.1.2.1 Differences between XRF results and fixed-base laboratory results**

Some differences between XRF results and fixed-base laboratory results are expected due to the differences in how the constituents were measured [i.e., the XRF measures the secondary (fluorescent) X-rays emitted by elements after they have been stimulated by (primary) X-rays]. Thus, this technique tends to measure the concentrations of elements located near the surface of the sample, while the fixed-base laboratory method theoretically measures the concentration of an element located throughout the entire sample volume (assuming homogeneity and complete dissolution).

The XRF and the fixed-base laboratory results are expected to correlate generally (because they are expected to correlate generally, higher XRF results would be expected to be found when the laboratory result is higher). Many of the data collected with the XRF are consistent with the laboratory results; however, the degree to which these data correlate varies by analyte.

#### **B.2.1.3 Summary of Frequencies of Detection of Analytes and False Positive/Negative Results**

A summary of frequencies of false positive and false negative results in field data are compiled in Table B.3. A result was designated as a false positive if the XRF result was detected greater than the fixed-base laboratory result and as a false negative if the XRF was not detected or was detected less than a fixed-base laboratory result that was greater than the XRF detection limit.

The graphs (in the Attachment) and Table B.3 indicate that all metals except arsenic, chromium, lead, manganese, and uranium have a greater tendency toward a false positive XRF result. Thus, using these XRF data will overstate the risk from these constituents.

**Table B.3. Summary of Frequencies of False Positive and False Negative Results in Field Data**

<b>Analyte</b>	<b>Frequency of Detection for Field Data</b>	<b>Surface Background mg/kg</b>	<b>Frequency of False Positive Results</b>	<b>Frequency of False Negative Results</b>
Arsenic	120/162	12	4/17	13/17
Barium	162/162	200	15/17	2/17
Cadmium	0/162	0.21	0/17	0/17
Chromium	132/162	16	12/17	5/17
Iron	162/162	28,000	9/17	8/17
Lead	162/162	36	12/17	5/17
Manganese	162/162	1,500	0/17	17/17
Mercury	5/162	0.2	1/17	0/17
Nickel	49/162	21	4/17	9/17
Selenium	0/162	0.8	0/17	0/17
Silver	26/162	2.3	5/17	0/17
Uranium	75/162	4.9	10/17	0/17

**B.2.1.4 Summary**

Evaluation of the XRF data with laboratory data indicates the use of results for iron, lead, nickel, and uranium present the strongest case. In general, because of differences in detection limits, XRF detections near or below their detection limits may suggest incorrectly the presence of the metal is present above background levels.

Table B.4 summarizes the findings based on this DQA.

**Table B.4. DQA Findings for Use of XRF Data**

<b>Analysis</b>	<b>Correlation</b>	<b>Use for Nature and Extent/Hot Spots?</b>	<b>Use for Risk Assessment?</b>	<b>Comments</b>
Arsenic	Potentially	Yes	Yes	Most values below background
Barium	Marginal	Yes	Yes	XRF results mostly > background; lab results mostly < background
Cadmium	No	Yes	No	No correlation because no XRF detections; few laboratory detections
Chromium	Marginal	Yes	Yes	XRF results mostly > background; laboratory results mostly approximately equal to or below background
Iron	Marginal	Yes	Yes	Most results below background for both methods
Lead	Yes	Yes	Yes	Somewhat good correlation; Most results are below background for both methods
Manganese	Yes	Yes	Yes	Somewhat good correlation; XRF results lower than laboratory results
Mercury	Marginal	Yes	Yes	Correlation marginal because only one XRF detection; laboratory results near background
Nickel	Yes	Yes	Yes	Good correlation
Selenium	No	Yes	Yes	No correlation because no XRF detections; no laboratory detections
Silver	Marginal	Yes	Yes	Few XRF detections; no laboratory detections
Uranium	Yes	Yes	Yes	Good correlation

## B.2.2 PCBS

Consistent with the SAP addendum, 162 samples were analyzed for PCBs using field test kits, and approximately 10% of these were split with the analytical laboratory to evaluate potential uncertainties or biases in the results.

Table B.5 is an overview of the results from the field tests.

**Table B.5. Ranges of PCB Test Kit Results**

Analysis	Units	ALL PCB DATA			PAIRED PCB DATA		
		FOD	Min	Max	FOD	Min	Max
Total PCBs	mg/kg	62/162	1	5	7/17	1	5

FOD = frequency of detection

The detection limit for the field test kits was 1 mg/kg, compared to approximately 0.12 mg/kg for the laboratory results. Results of field test kits were either 1U mg/kg or ranged from 1–5 mg/kg. Those ranging 1–5 mg/kg are reported in OREIS as 5U mg/kg, but for this comparison, are considered detections. Because SWMU 4 has detectable PCBs, the exposure point concentration may overestimate significantly the exposure concentration when incorporating the field results that were below detection limits.

The 17 confirmatory samples were collected to evaluate the results of the field data. All laboratory results were reported as less than 1 mg/kg or not detected. This comparison suggests field results are not expected to underestimate the levels of PCBs; however, their use would significantly overestimate risk.

The PCB field results are usable for identification of hot spots, but should not be used to support the risk assessment.

## B.3. REFERENCES

DOE (U.S. Department of Energy) 2006. *Work Plan for the Burial Ground Operable Unit Remedial Investigation/Feasibility Study at the Paducah Gaseous Diffusion Plant Paducah, Kentucky*, DOE/OR/07-2179&D2/R1, U.S. Department of Energy, Paducah, KY, November.

DOE 2014. *Addendum to the Work Plan for the Burial Grounds Operable Unit Remedial Investigation/Feasibility Study at the Paducah Gaseous Diffusion Plant Paducah, Kentucky, Solid Waste Management Unit 4 Sampling and Analysis Plan*, DOE/OR/07-2179&D2/A2/R3, U.S. Department of Energy, Kevil, KY, August.

DOE 2015. *Methods for Conducting Risk Assessment and Risk Evaluations at the Paducah Gaseous Diffusion Plant Paducah, Kentucky, Volume 1. Human Health*, DOE/LX/07-0107&D2/R6/V1, U.S. Department of Energy, Kevil, KY, August.

EPA (U.S. Environmental Protection Agency) 1992. *Guidance for Data Usability in Risk Assessment (Part A)*, Publication 9285.7-09A, U. S. Environmental Protection Agency, Washington, DC, April.



KRCEE (Kentucky Research Consortium for Energy and Environment) 2008. *Real Time Demonstration Project XRF Performance Evaluation Report for Paducah Gaseous Diffusion Plant AOC 492*, prepared by Dr. Robert L. Johnson for Kentucky Research Consortium for Energy and Environment, Lexington, KY, April 3.

**THIS PAGE INTENTIONALLY LEFT BLANK**

**APPENDIX B ANALYTICAL DATA (CD)**

**ATTACHMENT B1 XRF STATISTICS (CD)**

**THIS PAGE INTENTIONALLY LEFT BLANK**

**Appendix B Analytical Data and Attachment B1 information included on CD (see back cover).**

**THIS PAGE INTENTIONALLY LEFT BLANK**

**APPENDIX C**  
**HUMAN HEALTH RISK SCREENING**

**THIS PAGE INTENTIONALLY LEFT BLANK**



## HUMAN HEALTH RISK SCREENING

The summary of data collected from Solid Waste Management Unit (SWMU) 4 sampling is presented in Tables 4.4 and 4.5 of the main text for surface soils and subsurface soils, respectively. Tables 4.13 and 4.14 of the main text summarize groundwater sampling in the Regional Gravel Aquifer (RGA) and the McNairy Flow System (McNairy), respectively. Upper Continental Recharge System groundwater sampling is summarized in Table 4.12 of the main text; however, potential risks are not quantified from this unit because it is not considered to be an aquifer due to low yield.

Data included in these tables are all samples collected during the Burial Grounds Operable Unit (BGOU) SWMU 4 Work Plan Addendum sampling, Waste Area Grouping 3 Remedial Investigation (DOE 2000a), the Data Gaps Investigation (DOE 2000b), the Southwest Plume Site Investigation (DOE 2007), and routine site sampling data available from the Paducah Site database (OREIS). The tables provide a summary of analyses that exceeded background values and no action level (NAL) criteria. According to the BGOU SWMU 4 Work Plan Addendum, data collected from the sampling effort would be used to conduct a risk screening for the industrial worker (DOE 2014). Because industrial worker risk screening is applicable to surface soil (0–1 ft bgs), excavation worker NALs have been used for screening the subsurface soil [including surface soil (0–20 ft bgs)] within this appendix. Additionally, for exposure to groundwater, NALs for the child resident exposure scenario were used because no NALs for an industrial worker being exposed to groundwater have been established (DOE 2014).

### C.1. NAL/BACKGROUND EXCEEDANCES FOR SWMU 4 IN SOIL

The analytes listed in Table C.1 exceed both NAL and background values (if available). Where applicable, frequencies of exceedance (FOEs) are shown listing the number of samples with detected results greater than the screening criteria per total number of samples.

**Table C.1. SWMU 4 Analytes Exceeding Soil Screening Levels<sup>a</sup>**

Analysis Exceeding Screening Levels	Surface Soil (0–1 ft bgs) <sup>b</sup>		Surface and Subsurface Soil (0–20 ft bgs) <sup>b</sup>	
	FOE Background <sup>c</sup>	FOE Industrial Worker NAL <sup>c</sup>	FOE Background <sup>c</sup>	FOE Excavation Worker NAL <sup>c</sup>
Arsenic	6/191	144/191	40/334	189/334
Chromium <sup>d</sup>	141/191	1/191	Screening not Necessary	No Exceedances
Cobalt	No Exceedances	No Exceedances	2/79	4/79
Iron	4/191	1/191	13/334	18/334
Manganese	3/191	1/191	19/334	20/334
Mercury	Screening not Necessary	No Exceedances	17/316	1/316
Nickel	Screening not Necessary	No Exceedances	72/334	7/334
Uranium	92/179	17/179	131/259	82/259
Total polychlorinated biphenyls (PCBs)	No Background Value Available	85/237	No Background Value Available	89/403
Total polycyclic aromatic hydrocarbons (PAH)	No Background Value Available	2/44	No Background Value Available	2/183

**Table C.1. SWMU 4 Analytes Exceeding Soil Screening Levels (Continued)**

Analysis Exceeding Screening Levels	Surface Soil (0–1 ft bgs) <sup>b</sup>		Surface and Subsurface Soil (0–20 ft bgs) <sup>b</sup>	
	FOE Background <sup>c</sup>	FOE Industrial Worker NAL <sup>c</sup>	FOE Background <sup>c</sup>	FOE Excavation Worker NAL <sup>c</sup>
	Cesium-137	5/52	18/52	20/221
Neptunium-237	20/45	11/45	No Background Value Available	9/140
Plutonium-239/240 <sup>e</sup>	Screening not Necessary	No Exceedances	No Background Value Available	1/141
Thorium-230	18/40	1/40	34/119	3/119
Uranium-234	32/39	2/39	84/134	12/134
Uranium-235	27/46	15/46	68/214	12/214
Uranium-238	32/39	32/39	87/134	55/134

<sup>a</sup> Screening for background exceedance was not conducted if NAL was not exceeded. This is denoted as “Screening not Necessary” within the table.

<sup>b</sup> Data set for surface soil 0–1 ft bgs is compared to surface soil background values. Data set for surface and subsurface soil 0-20 ft bgs is compared to subsurface soil background values.

<sup>c</sup> Background and NAL values taken from the Risk Methods Document, Tables A.12 and A.4, respectively (DOE 2015).

<sup>d</sup> Chromium is assessed as chromium (total).

<sup>e</sup> Plutonium-239/240 is assessed as plutonium-239.

The locations of the surface soil exceedances are shown on Figures 4.1–4.3. Subsurface soil exceedances for uranium and uranium-238 can be found on Figures 4.5 and 4.8, respectively. Other exceedances are dispersed throughout the SWMU burial areas.

Of those exceeding screening levels, iron (in 1 sample), Total PCBs (in 2 samples), and uranium-238 (in 1 sample) exceed industrial worker action levels in surface soil. Iron (in 1 sample), manganese (in 1 sample), uranium (in 4 samples), Total PCBs (in 1 sample), uranium-235 (in 1 sample), and uranium-238 (in 3 samples) exceed excavation worker action levels in the surface and subsurface soil.

### C.1.1 DERIVATION OF RISK ESTIMATES FOR COPCS FOR SOIL

For each chemical or radionuclide of potential concern (COPC) for soil, the exposure point concentration (EPC) was calculated using U.S. Environmental Protection Agency’s (EPA’s) ProUCL software (v.5.0), denoting nondetect values (Attachment C1). These EPCs are presented in Table C.2. EPCs for surface soil were compared to risk-based concentrations to determine an estimate of risk for the industrial worker scenario (direct contact with soil and sediment for 250 days per year over a 25-year period). For subsurface soil, the dataset was limited to 0–20 ft bgs. The Risk Methods Document lists 0-16 ft bgs for comparison to the excavation worker; however, the maximum depth of 20 ft is used in order to fully encompass the maximum depth of burial (see Section 1.3.2). Subsurface soil EPCs were compared to risk-based concentrations for the excavation worker scenario (direct contact with soil and sediment for 185 days per year over a 5-year period). These risk-based concentrations were taken from Table A.4 in DOE 2015 and are shown in Table C.2.

**Table C.2. SWMU 4 Surface and Subsurface Soil COPC EPCs and Risk-Based Concentrations**

COPC	Surface (0–1 ft bgs)			Surface and Subsurface (0–20 ft bgs)		
	EPC	Industrial Worker NAL <sup>a</sup>		EPC	Excavation Worker NAL <sup>a</sup>	
		Cancer	Hazard		Cancer	Hazard
<b>Metals (mg/kg)</b>						
Arsenic	5.98E+00	1.41E+00	2.27E+01	5.08E+00	2.52E+00	8.10E+00
Chromium <sup>b</sup>	4.59E+01	1.98E+02	1.00E+05			
Cobalt				5.81E+00	1.25E+04	9.84E+00
Iron	1.47E+04	N/A	1.00E+05	1.41E+04	N/A	2.30E+04
Manganese	1.57E+03	N/A	4.72E+03	7.57E+02	N/A	7.74E+02
Mercury				5.17E-01	N/A	9.86E+00
Nickel				1.10E+02	1.00E+05	6.52E+02
Uranium	2.76E+02	N/A	6.81E+02	7.52E+02	N/A	9.83E+01
<b>Organics (mg/kg)</b>						
Total PAH <sup>c</sup>	1.71E+00	8.94E-02	N/A	1.71E+00	3.25E-01	N/A
Total PCBs	5.19E+00	3.05E-01	N/A	4.76E+00	1.14E+00	N/A
<b>Radionuclides (pCi/g)</b>						
Cesium-137	2.45E-01	1.02E-01	N/A	1.66E+00	6.84E-01	N/A
Neptunium-237	1.55E+00	2.29E-01	N/A	6.41E+00	1.50E+00	N/A
Plutonium-239/240 <sup>d</sup>				3.93E+00	1.85E+01	N/A
Thorium-230	9.62E+00	3.39E+01	N/A	3.61E+01	2.85E+01	N/A
Uranium-234	1.78E+01	5.53E+01	N/A	2.52E+02	4.35E+01	N/A
Uranium-235	1.32E+00	3.40E-01	N/A	1.01E+01	2.20E+00	N/A
Uranium-238	4.59E+01	1.60E+00	N/A	4.03E+02	8.72E+00	N/A

Grayed cells indicate the chemical or radionuclide is not a COPC for the scenario listed (see Table C.1); therefore, EPCs are not calculated and the NALs are not shown.

<sup>a</sup>NAL values taken from the Risk Methods Document, Table A.4 (DOE 2015).

<sup>b</sup>Chromium is assessed as chromium (total).

<sup>c</sup>EPC for Total PAH is the maximum detected value.

<sup>d</sup>Plutonium-239/240 is assessed as plutonium-239.

The equation used to derive the risk estimate for each COPC (i.e., chemical-specific cancer risk or hazard) is as follows:

$$\text{Risk} = \frac{\text{Exposure Concentration}}{\text{Screening Value}} \times \text{Target Risk Value}$$

where:

Risk = calculated chemical or radionuclide-specific cancer risk or hazard value.

Exposure Concentration = EPC taken from Table C.2.

Screening Value = Cancer and hazard concentrations taken from Table C.2.

Target Risk Value = Cancer risk (1E-06) or hazard (0.1) upon which the screening value is based.

Results of the application of this equation are presented in Table C.3. The cumulative hazard and cancer risk for exposure to SWMU 4 soils are listed in Table C.4.

**Table C.3. Chemical-Specific Potential Hazards and Cancer Risk Posed to the Industrial Worker and Excavation Worker by COPCs Found in SWMU 4 Soils**

COPC	Industrial Worker		Excavation Worker	
	Cancer	Hazard	Cancer	Hazard
<i>Metals</i>				
Arsenic	<b>4.2E-06</b>	< 0.1	<b>2.0E-06</b>	< 0.1
Chromium	< 1E-06	< 0.1	N/A	N/A
Cobalt	N/A	N/A	< 1E-06	< 0.1
Iron	N/A	< 0.1	N/A	< 0.1
Manganese	N/A	< 0.1	N/A	< 0.1
Mercury	N/A	N/A	N/A	< 0.1
Nickel	N/A	N/A	< 1E-06	< 0.1
Uranium	N/A	< 0.1	N/A	0.8
<i>Organics</i>				
Total PAH	<b>1.9E-05</b>	N/A	<b>5.3E-06</b>	N/A
Total PCBs	<b>1.7E-05</b>	N/A	<b>4.2E-06</b>	N/A
<i>Radionuclides</i>				
Cesium-137	<b>2.4E-06</b>	N/A	<b>2.4E-06</b>	N/A
Neptunium-237	<b>6.8E-06</b>	N/A	<b>4.3E-06</b>	N/A
Plutonium-239/240	N/A	N/A	< 1E-06	N/A
Thorium-230	< 1E-06	N/A	<b>1.3E-06</b>	N/A
Uranium-234	< 1E-06	N/A	<b>5.8E-06</b>	N/A
Uranium-235	<b>3.9E-06</b>	N/A	<b>4.6E-06</b>	N/A
Uranium-238	<b>2.9E-05</b>	N/A	<b>4.6E-05</b>	N/A

Cancer risks above 1E-06 and noncancer hazards above 1 are shown in bold. Grayed cells indicate the chemical or radionuclide is not a COPC for the scenario listed; therefore, potential cancer risk and noncancer hazard are not estimated.

**Table C.4. Cumulative Potential Hazard and Cancer Risk Posed to the Industrial Worker and Excavation Worker by COPCs Found in SWMU 4 Soils**

Scenario	Depth	Cancer	Hazard
Industrial Worker	Surface	<b>8.3E-05</b>	0.1
Excavation Worker	Surface and subsurface	<b>7.6E-05</b>	<b>1.1</b>

Cancer risks above 1E-06 and noncancer hazards above 1 are shown in bold. Cancer risks above 1E-04 and noncancer hazards above 3 are shown in bold italics.

## C.2. NAL/BACKGROUND EXCEEDANCES FOR SWMU 4 IN GROUNDWATER

The analytes listed in Table C.5 exceed both NAL and background values (if available) for groundwater in the RGA and McNairy. Frequencies are marked as N/A, if there are no criteria to screen against (e.g., no background value is available) or if both criteria are available, but one is not necessary because there are no exceedances for the other criteria (e.g., no exceedances of NAL, so background screen is N/A). Where applicable, FOEs are shown listing the number of samples with detected results greater than the screening criteria per total number of samples.

**Table C.5. SWMU 4 Analytes Exceeding Groundwater Screening Levels**

Analysis Exceeding Screening Levels	RGA		McNairy	
	FOE Background <sup>a</sup>	FOE NAL <sup>b</sup>	FOE Background <sup>a</sup>	FOE NAL <sup>b</sup>
<b><i>Inorganics—Metals</i></b>				
Aluminum	31/124	31/124	12/34	12/34
Arsenic	55/89	72/89	6/20	6/20
Barium	30/125	18/125	9/34	9/34
Beryllium	10/80	10/80	8/28	8/28
Boron	No Background Value Available	No Exceedances	No Background Value Available	1/3
Cadmium	No Exceedances	Screening not Necessary	7/26	8/26
Chromium <sup>c</sup>	3/69	6/69	8/26	8/26
Cobalt	21/119	86/119	8/32	18/32
Copper	3/63	1/63	8/26	7/26
Fluoride	1/24	13/24	No Analyses	No Analyses
Iron	41/126	53/126	12/34	15/34
Lead <sup>d</sup>	2/60	3/60	8/26	8/26
Manganese	112/126	118/126	15/34	34/34
Mercury	2/62	1/62	7/26	6/26
Nickel	1/79	11/79	3/18	3/18
Selenium	9/57	2/57	No Exceedances	No Exceedances
Vanadium	7/67	8/67	8/28	9/28
Zinc	17/89	4/89	10/30	8/30
<b><i>Organics—VOAs</i></b>				
1,1,2-Trichloroethane	No Background Value Available	2/160	No Background Value Available	No Exceedances
1,1-Dichloroethane	No Background Value Available	2/160	No Background Value Available	No Exceedances
1,1-Dichloroethene	No Background Value Available	62/269	No Background Value Available	3/12
1,2-Dichloroethane	No Background Value Available	1/160	No Background Value Available	No Exceedances
1,2-Dimethylbenzene <sup>e</sup>	No Background Value Available	5/128	No Background Value Available	No Exceedances
Benzene	No Background Value Available	7/238	No Background Value Available	No Exceedances
Carbon tetrachloride	No Background Value Available	71/238	No Background Value Available	No Exceedances
Chloroform	No Background Value Available	76/238	No Background Value Available	No exceedances
<i>cis</i> -1,2-Dichloroethene	No Background Value Available	173/270	No Background Value Available	2/12
Ethylbenzene	No Background Value Available	6/238	No Background Value Available	No Exceedances
Total Xylene <sup>f</sup>	No Background Value Available	5/188	No Background Value Available	No Exceedances
<i>trans</i> -1,2-Dichloroethene	No Background Value Available	8/192	No Background Value Available	No Exceedances
Trichloroethene	No Background Value Available	299/314	No Background Value Available	6/12
Vinyl chloride	No Background Value Available	57/270	No Background Value Available	No Exceedances

**Table C.5. SWMU 4 Analytes Exceeding Groundwater Screening Levels (Continued)**

Analysis Exceeding Screening Levels	RGA		McNairy	
	FOE Background <sup>a</sup>	FOE NAL <sup>b</sup>	FOE Background <sup>a</sup>	FOE NAL <sup>b</sup>
<b>Radionuclides</b>				
Neptunium-237	3/17	3/17	No Analyses	No Analyses
Technetium-99	131/288	142/288	2/12	2/12
Thorium-230	No Background Value Available	1/22	No Background Value Available	No Analyses
Uranium-234	1/4	1/4	No Analyses	No Analyses

Screening for background exceedance was not conducted if NAL was not exceeded. This is denoted as “Screening not Necessary” within the table.

<sup>a</sup> RGA and McNairy background values are reported in the Risk Methods Document, Table A.13, and are taken from the “Over All Observations” values (DOE 2015).

<sup>b</sup> The NALs are the lesser of the values for HI of 0.1 for the child resident and excess lifetime cancer risk of 1E-06 for the adult/child combined lifetime resident [Risk Methods Document, Table A.5 (DOE 2015)].

<sup>c</sup> Chromium is assessed as chromium (total).

<sup>d</sup> Lead is screened using benchmarks consistent with the BGOU SWMU 4 Work Plan Addendum. Additional modeling is not performed.

<sup>e</sup> Note that 1,2-dimethylbenzene is also known as o-xylene.

<sup>f</sup> Total Xylene is assessed as xylene, mixture.

The locations of the groundwater exceedances are shown on Figures in Section 4. Of those exceeding screening levels, aluminum; arsenic; beryllium; chromium; cobalt; iron; lead; manganese; vanadium; 1,1,2-trichloroethane; 1,1-dichloroethene; carbon tetrachloride; chloroform; *cis*-1,2-dichloroethene; trichloroethene; and vinyl chloride exceed action levels in RGA groundwater. In the McNairy, aluminum, arsenic, beryllium, cadmium, chromium, cobalt, iron, lead, manganese, vanadium, and trichloroethene exceed action levels. Additional information can be found in Section 4.4 of the main text.

### C.2.1 DERIVATION OF RISK ESTIMATES FOR COPCS FOR GROUNDWATER

For each COPC for groundwater of which there were sufficient results, the EPC was calculated using EPA’s ProUCL software (v.5.0), denoting nondetect values (Attachment C2). Three COPCs, 1,2-dichloroethane (RGA); uranium-234 (RGA); and boron (McNairy), did not have sufficient results to calculate an EPC using ProUCL, and the maximum detected result was used as the EPC. All EPCs are presented in Table C.6. EPCs for each aquifer were compared to risk-based concentrations to determine an estimate of risk for the child resident scenario (because no NALs for an industrial worker being exposed to groundwater have been established). These risk-based concentrations were taken from Table A.5 in DOE 2015 and are shown in Table C.6.

**Table C.6. SWMU 4 Groundwater COPC EPCs and Risk-Based Concentrations**

COPC	RGA EPC	McNairy EPC	Resident Cancer NAL <sup>a</sup>	Child Resident Hazard NAL <sup>a</sup>
<b>Metals (mg/L)</b>				
Aluminum	4.49E+01	7.26E+01	N/A	1.99E+00
Arsenic	1.14E-02	3.24E-02	5.16E-05	5.98E-04
Barium	4.05E-01	1.45E+00	N/A	3.70E-01
Beryllium	6.70E-03	2.59E-02	N/A	2.19E-03
Boron		2.47E+00	N/A	3.99E-01
Cadmium		2.49E-02	N/A	8.98E-04
Chromium <sup>b</sup>	8.09E-02	2.12E-01	N/A	2.08E+00
Cobalt	6.68E-02	2.61E-01	N/A	6.00E-04

**Table C.6. SWMU 4 Groundwater COPC EPCs and Risk-Based Concentrations (Continued)**

<b>COPC</b>	<b>RGA EPC</b>	<b>McNairy EPC</b>	<b>Resident Cancer NAL<sup>a</sup></b>	<b>Child Resident Hazard NAL<sup>a</sup></b>
<b><i>Metals (mg/L) (Continued)</i></b>				
Copper	4.91E-02	1.96E-01	N/A	7.98E-02
Fluoride	1.69E-01		N/A	7.98E-02
Iron	1.62E+02	1.41E+03	N/A	1.40E+00
Manganese	3.55E+00	8.02E+00	N/A	4.20E-02
Mercury	2.99E-04	1.23E-03	N/A	5.56E-04
Nickel	6.16E-02	1.97E-01	N/A	3.90E-02
Selenium	5.81E-03		N/A	9.97E-03
Vanadium	3.70E-01	1.89E+00	N/A	8.26E-03
Zinc	2.09E-01	1.40E+00	N/A	6.00E-01
<b><i>Organics (mg/L)</i></b>				
1,1,2-Trichloroethane	1.40E-03		2.75E-04	4.15E-05
1,1-Dichloroethane	1.53E-03		2.75E-03	8.14E-02
1,1-Dichloroethene	3.86E-03	2.21E-03	1.71E-04	1.30E-03
1,2-Dichloroethane	2.00E-01		N/A	2.83E-02
1,2-Dimethylbenzene <sup>c</sup>	6.81E-03		N/A	1.92E-02
Benzene	1.25E-03		4.53E-04	3.29E-03
Carbon tetrachloride	2.22E-02		4.52E-04	4.84E-03
Chloroform	4.61E-02		2.21E-04	9.66E-03
<i>cis</i> -1,2-Dichloroethene	2.33E-01	4.44E-03	N/A	3.56E-03
Ethylbenzene	3.50E-03		1.49E-03	7.82E-02
Total Xylene <sup>d</sup>	1.99E-02		N/A	1.92E-02
<i>trans</i> -1,2-Dichloroethene	2.45E-03		N/A	9.26E-03
Trichloroethene	1.91E+00	5.93E-02	4.92E-04	2.81E-04
Vinyl chloride	1.62E-02		1.87E-05	4.39E-03
<b><i>Radionuclides (pCi/L)</i></b>				
Neptunium-237	-5.36E+00		7.63E-01	N/A
Technetium-99	1.06E+02	5.28E+01	1.90E+01	N/A
Thorium-230	4.83E-01		5.72E-01	N/A
Uranium-234	9.66E+00		7.39E-01	N/A

Grayed cells indicate the chemical or radionuclide is not a COPC for the aquifer listed (see Table C.5), therefore EPCs are not calculated.

<sup>a</sup> NAL values taken from the Risk Methods Document, Table A.5 (DOE 2015).

<sup>b</sup> Chromium is assessed as chromium (total).

<sup>c</sup> Note that 1,2-dimethylbenzene is also known as o-xylene.

<sup>d</sup> Total Xylene is assessed as xylene, mixture.

The equation used to derive the risk estimate for each COPC (i.e., chemical-specific cancer risk or hazard) the same equation as for soil:

$$\text{Risk} = \frac{\text{Exposure Concentration}}{\text{Screening Value}} \times \text{Target Risk Value}$$

where:

Risk = calculated chemical or radionuclide-specific cancer risk or hazard value.

Exposure Concentration = EPC taken from Table C.6.

Screening Value = Cancer and hazard concentrations taken from Table C.6.

Target Risk Value = Cancer risk (1E-06) or hazard (0.1) upon which the screening value is based.

Results of the application of this equation are presented in Table C.7. The cumulative hazard and cancer risk for SWMU 4 exposure to groundwater are listed in Table C.8.

**Table C.7. Chemical-Specific Potential Hazards and Cancer Risk Posed to the Child Resident by COPCs Found in SWMU 4 Groundwater**

COPC	RGA		McNairy	
	Cancer	Hazard	Cancer	Hazard
<b>Metals</b>				
Aluminum	N/A	<b>2.3</b>	N/A	<b>3.6</b>
Arsenic	<b>2.2E-04</b>	<b>1.9</b>	<b>6.3E-04</b>	<b>5.4</b>
Barium	N/A	0.1	N/A	0.4
Beryllium	N/A	0.3	N/A	<b>1.2</b>
Boron	N/A	N/A	N/A	0.6
Cadmium	N/A	N/A	N/A	<b>2.8</b>
Chromium	N/A	0.0	N/A	0.0
Cobalt	N/A	<b>11.1</b>	N/A	<b>43.5</b>
Copper	N/A	0.1	N/A	0.2
Fluoride	N/A	0.2	N/A	N/A
Iron	N/A	<b>11.6</b>	N/A	<b>100.7</b>
Manganese	N/A	<b>8.5</b>	N/A	<b>19.1</b>
Mercury	N/A	0.1	N/A	0.2
Nickel	N/A	0.2	N/A	0.5
Selenium	N/A	0.1	N/A	N/A
Vanadium	N/A	<b>4.5</b>	N/A	<b>22.9</b>
Zinc	N/A	0.0	N/A	0.2
<b>Organics</b>				
1,1,2-Trichloroethane	<b>5.1E-06</b>	<b>3.4</b>	N/A	N/A
1,1-Dichloroethane	5.6E-07	0.0	N/A	N/A
1,1-Dichloroethene	<b>2.3E-05</b>	0.3	<b>1.3E-05</b>	0.2
1,2-Dichloroethane	N/A	0.7	N/A	N/A
1,2-Dimethylbenzene	N/A	0.0	N/A	N/A
Benzene	<b>2.8E-06</b>	0.0	N/A	N/A
Carbon tetrachloride	<b>4.9E-05</b>	0.5	N/A	N/A
Chloroform	<b>2.1E-04</b>	0.5	N/A	N/A
cis-1,2-Dichloroethene	N/A	<b>6.5</b>	N/A	0.1
Ethylbenzene	<b>2.3E-06</b>	0.0	N/A	N/A
Total Xylene	N/A	0.1	N/A	N/A
trans-1,2-Dichloroethene	N/A	0.0	N/A	N/A
Trichloroethene	<b>3.9E-03</b>	<b>679.7</b>	<b>1.2E-04</b>	<b>21.1</b>
Vinyl chloride	<b>8.7E-04</b>	0.4	N/A	N/A
<b>Radionuclides</b>				
Neptunium-237	-7.0E-06	N/A	N/A	N/A
Technetium-99	<b>5.6E-06</b>	N/A	<b>2.8E-06</b>	N/A
Thorium-230	8.4E-07	N/A	N/A	N/A
Uranium-234	<b>1.3E-05</b>	N/A	N/A	N/A

Grayed cells indicate the chemical or radionuclide is not a COPC for the aquifer listed; therefore, potential cancer risk and noncancer hazard are not estimated.

Cancer risks above 1E-06 and noncancer hazards above 1 are shown in bold.

Cancer risks above 1E-04 and noncancer hazards above 3 are shown in bold italics.



**Table C.8. Cumulative Potential Hazard and Cancer Risk Posed to the Child Resident by COPCs Found in SWMU 4 Groundwater**

<b>Scenario</b>	<b>Depth</b>	<b>Cancer</b>	<b>Hazard</b>
Child Resident	RGA	<b><i>5.3E-03</i></b>	<b><i>732.9</i></b>
	McNairy	<b><i>7.6E-04</i></b>	<b><i>222.8</i></b>

Cancer risks above 1E-06 and noncancer hazards above 1 are shown in bold.  
 Cancer risks above 1E-04 and noncancer hazards above 3 are shown in bold italics.

### C.3. REFERENCES

- DOE (U.S. Department of Energy) 2000a. *Remedial Investigation Report for Waste Area Grouping 3 at the Paducah Gaseous Diffusion Plant, Paducah, Kentucky*, DOE/OR/07-1895/V1-V4&D1, U.S. Department of Energy, Paducah, KY, September.
- DOE 2000b. *Data Report for the Sitewide Remedial Evaluation for Source Areas Contributing to Off-Site Groundwater Contamination at the Paducah Gaseous Diffusion Plant, Paducah, Kentucky*, DOE/OR/07-1845&D1, U.S. Department of Energy, Paducah, KY, January.
- DOE 2007. *Site Investigation Report for the Southwest Plume at the Paducah Gaseous Diffusion Plant, Paducah, Kentucky*, DOE/OR/07-2180&D2/R1, U.S. Department of Energy, Paducah, KY, June.
- DOE 2014. *Addendum to the Work Plan for the Burial Grounds Operable Unit Remedial Investigation/Feasibility Study at the Paducah Gaseous Diffusion Plant, Paducah, Kentucky, Solid Waste Management Unit 4 Sampling and Analysis Plan*, DOE/OR/07-2179&D2/A2/R3, U.S. Department of Energy, Kevil, KY, August.
- DOE 2015. *Methods for Conducting Risk Assessments and Risk Evaluations at the Paducah Gaseous Diffusion Plant, Paducah, Kentucky Volume 1, Human Health*, DOE/LX/07-0107&D2/R6/V1, U.S. Department of Energy, Kevil, KY, July.

**THIS PAGE INTENTIONALLY LEFT BLANK**

**ATTACHMENT C1  
PROUCL OUTPUT FOR SOILS**

**ATTACHMENT C2  
PROUCL OUTPUT FOR GROUNDWATER**

**THIS PAGE INTENTIONALLY LEFT BLANK**

**Attachments C1 and C2 information included on CD (see back cover).**

**THIS PAGE INTENTIONALLY LEFT BLANK**

**APPENDIX D**  
**SCREENING ECOLOGICAL**  
**RISK ASSESSMENT**

**THIS PAGE INTENTIONALLY LEFT BLANK**



# CONTENTS

FIGURES.....	D-5
TABLES .....	D-5
ACRONYMS.....	D-7
D.1. INTRODUCTION .....	D-9
D.1.1 SITE LOCATION.....	D-9
D.1.2 SITE HISTORY.....	D-9
D.2. PROBLEM FORMULATION.....	D-9
D.2.1 PRELIMINARY CONCEPTUAL SITE MODEL .....	D-9
D.2.1.1 Site Environmental Setting and Habitat Descriptions .....	D-9
D.2.1.2 Data.....	D-16
D.2.1.3 Site Contaminants.....	D-16
D.2.1.4 Fate and Transport Mechanisms.....	D-16
D.2.2 POTENTIALLY COMPLETE EXPOSURE PATHWAYS .....	D-17
D.2.3 POTENTIALLY CONTAMINATED MEDIA .....	D-17
D.3. SCREENING-LEVEL EFFECTS EVALUATION.....	D-17
D.4. UNCERTAINTIES .....	D-18
D.5. CONCLUSIONS .....	D-19
D.6. REFERENCES .....	D-19
ATTACHMENT D1: ADDITIONAL ESVS.....	D1-1
ATTACHMENT D2: SWMU 4 DATA SUMMARY AND ECOLOGICAL SCREENING.....	D2-1

**THIS PAGE INTENTIONALLY LEFT BLANK**

## FIGURES

D.1. Location of SWMU 4.....	D-10
D.2. Preliminary Conceptual Site Model for SWMU 4 .....	D-11
D.3. Photograph of SWMU 4 (Photo north looking south) .....	D-13

## TABLES

D.1. Ecological Screening of SWMU 4 .....	D-12
D.2. Wildlife Species Present or Potentially Present at the PGDP Site .....	D-14
D.3. Federally Listed, Proposed, and Candidate Species Potentially Occurring within the Paducah Site Study Area .....	D-16
D.4. Summary of Suite of COPECs Retained in Surface Soil and Shallow Subsurface Soil (0–5 ft bgs) .....	D-19

**THIS PAGE INTENTIONALLY LEFT BLANK**

## ACRONYMS

COPEC	chemical or radionuclide of potential ecological concern
CSM	conceptual site model
DOE	U.S. Department of Energy
ESV	ecological screening value
HI	hazard index
HQ	hazard quotient
NFA	no further action
PAH	polycyclic aromatic hydrocarbon
PGDP	Paducah Gaseous Diffusion Plant
SERA	screening ecological risk assessment
SVOC	semivolatile organic compound
SWMU	solid waste management unit
VOC	volatile organic compound
WKWMA	West Kentucky Wildlife Management Area

**THIS PAGE INTENTIONALLY LEFT BLANK**

## **D.1. INTRODUCTION**

### **D.1.1 SITE LOCATION**

This appendix provides the results of the screening ecological risk assessment (SERA) completed for Solid Waste Management Unit (SWMU) 4 at the Paducah Gaseous Diffusion Plant (PGDP) (Figure D.1). Some of the area surrounding the PGDP facility is a recreational wildlife area, the West Kentucky Wildlife Management Area (WKWMA), with residential areas lying beyond the WKWMA. Private land in rural residential and agricultural areas also borders the PGDP facility.

### **D.1.2 SITE HISTORY**

The site history of SWMU 4 is described in Chapter 1 of this Addendum.

## **D.2. PROBLEM FORMULATION**

The first step in preparing a SERA includes the problem formulation. This step encompasses development of the preliminary conceptual site model (CSM), determination of potentially complete exposure pathways and potentially contaminated media, selection of exposure endpoints, and selection of screening levels protective of the endpoints and potentially exposed receptors at the site.

### **D.2.1 PRELIMINARY CONCEPTUAL SITE MODEL**

The preliminary CSM includes a description of the environmental setting, known site contaminants, and a figure (Figure D.2) representing the potential exposure pathways. The figure shows several pathways as incomplete because groundwater recharge to surface water is not expected as a potential release mechanism at SWMU 4. This preliminary CSM is used as the basis for selection of benchmark values used to screen the site for potential ecological risk. The primary ecological receptors (i.e., the exposure endpoints) shown in the preliminary CSM are terrestrial animals and terrestrial plants. Specific groups included in terrestrial animals and plants that are the exposure endpoints shown in the preliminary CSM include reptiles and amphibians, birds, and mammals (see Section D.2.1.1). Screening values are protective of these endpoints and are discussed in Section D.3.

#### **D.2.1.1 Site Environmental Setting and Habitat Descriptions**

SWMU 4 is located inside the Limited Area. Although there is potential for contamination below the surface to migrate laterally toward surface water, the direction of shallow groundwater flow is primarily downward and represents limited risks to terrestrial receptors near these sites. This section presents a brief summary of the ecosystem relevant to defining the CSM and exposure pathways. Table D.1 and the following text describe ground cover and proximity to surface water/drainageways for SWMU 4. Figure D.3 displays a photograph of SWMU 4.

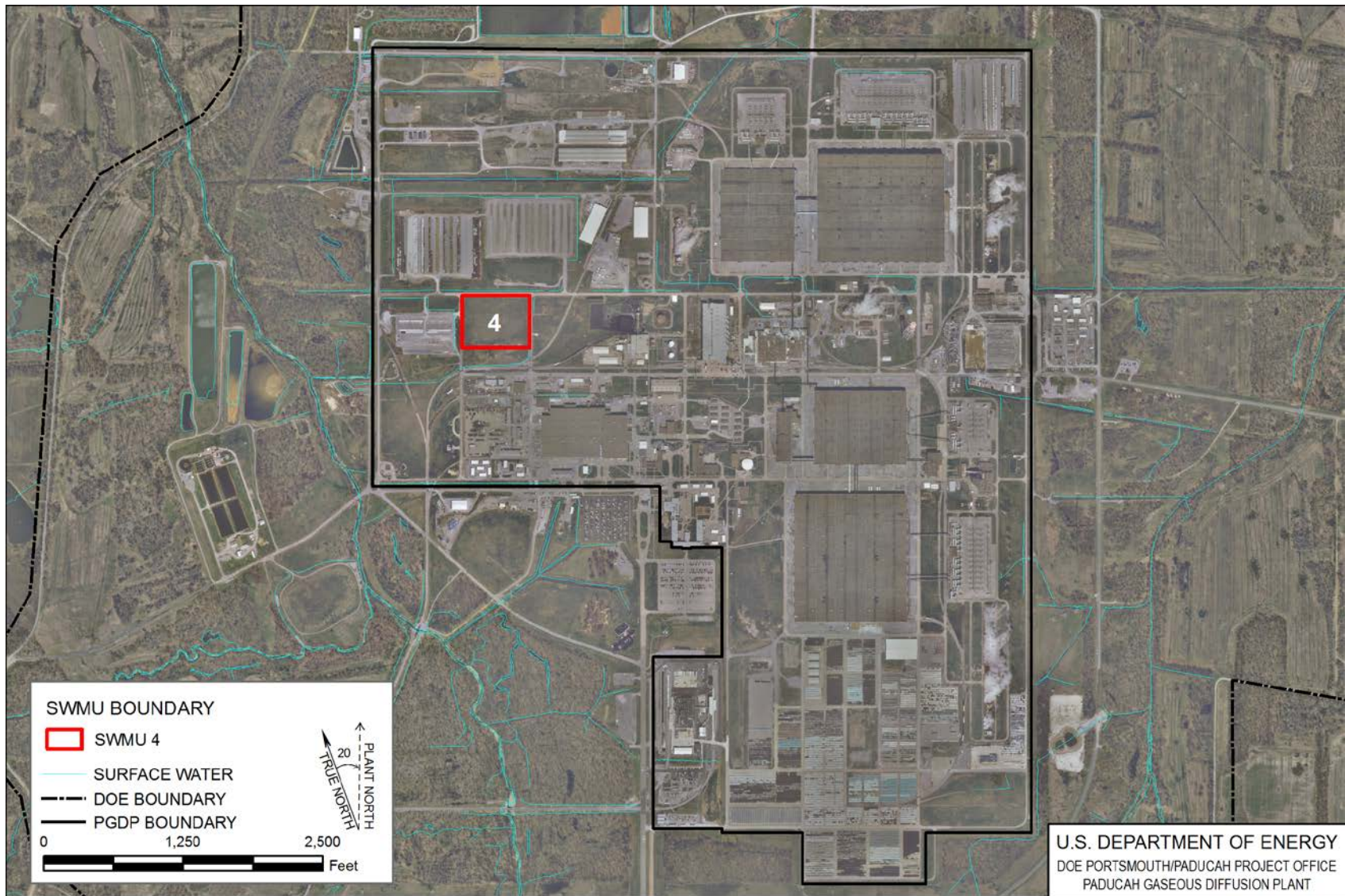

Figure D.1. Location of SWMU 4

U.S. DEPARTMENT OF ENERGY  
DOE PORTSMOUTH/PADUCAH PROJECT OFFICE  
PADUCAH GASEOUS DIFFUSION PLANT





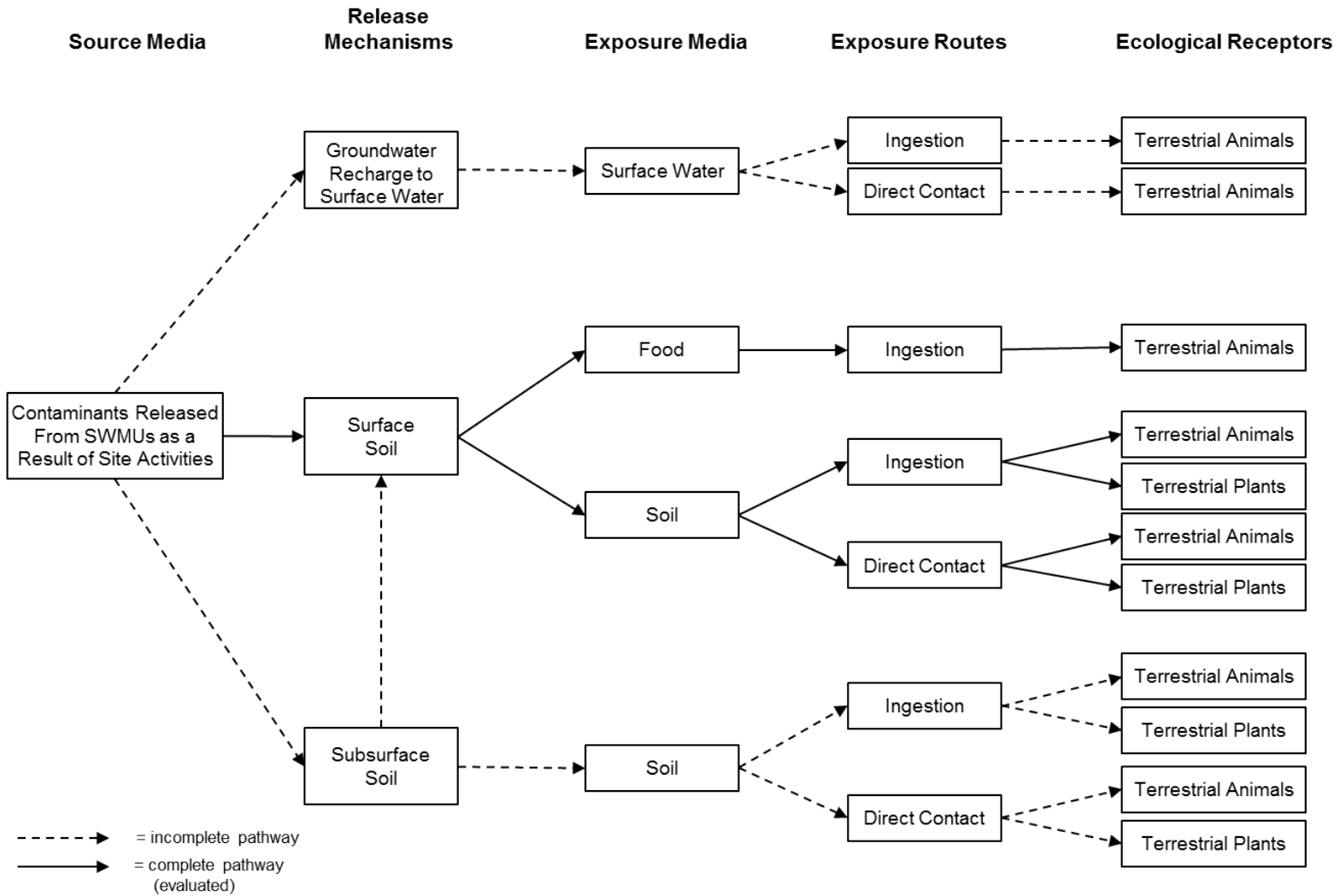

Figure D.2. Preliminary Conceptual Site Model for SWMU 4

**Table D.1. Ecological Screening of SWMU 4**

Description	SWMU	Area Acres	Ground Cover	Near a Surface Water Body?	Total Screening HI <sup>a</sup>	Priority COPECs	Background (mg/kg) <sup>b</sup>	Maximum Detection or 1/2 Maximum Detection Limit (mg/kg) <sup>c</sup>	Soil ESV (mg/kg)	Screening HQ <sup>a</sup>
Burial Area	4	6.58	Grass	Yes	13035	Aluminum	13000	16300	50	326
						Cadmium	0.21	15.6	0.36	43
						Chromium	16	296	26	11
						Iron	28000	125000	200	625
						Manganese	1500	44700	220	203
						Mercury	0.2	10	0.1	100
						Uranium	4.9	2840	5	568
						Total PCBs	N/A	222	0.02	11100
High molecular weight PAHs	N/A	12.14	1.1	11						

<sup>a</sup> The total Screening Hazard Index (HI) includes contributions from all of the COPECs (listed in Table D2.2); only priority COPECs [i.e., the COPECs with Screening Hazard Quotients (HQs) greater than 10] are shown in this table.

<sup>b</sup> Background values are for surface soil taken from DOE 2015a; ecological screening values (ESVs) are taken from DOE 2015b and Attachment D1.

<sup>c</sup> The screening values were selected from the surface and shallow subsurface data set (0–5 ft bgs). The screening value shown is the maximum detected value.



**Figure D.3. Photograph of SWMU 4  
(Photo north looking south)**

SWMU 4 is an open field that, at one time, was used for burial and disposal of various waste materials in designated burial cells. A short, narrow gravel road that enters from the west is nearly completely grass-covered. Except for this rarely used road, the entire site is covered with a variety of field grasses and clovers. The site typically is mowed once a month from April through September. SWMU 4 is bounded on three sides (north, east, and west) by shallow drainage swales that direct surface runoff to the northwest corner of the site. There is an elevation difference of approximately 10 ft between the highest point in the SWMU to the adjacent drainage swales. The entire burial yard was covered with 2 to 3 ft of soil material, and a 6-inch clay cap was placed over the area in 1982 (DOE 1998).

The primary ecosystem in the area outside the industrial area around SWMU 4 is upland grassland interspersed with developed industrial areas. The terrestrial ecosystems that occur in the SWMU 4 area are described more fully in the original work plan for BGOU (DOE 2006). The buffer area and areas bordering the PGDP facility include forest, thickets, and agricultural land. Much of the PGDP facility is surrounded by the WKWMA, which includes managed native prairie and deciduous forest. Species documented to occur in the area include numerous small mammals, particularly shrews, mice, and voles. Numerous bird species, including doves, turkey, quail, bluebirds and other songbirds, as well as hawks and owls, are found in this area. There also are amphibians, reptiles (primarily lizards and turtles), and bats. Table D.2 lists species observed in the nonindustrial areas of PGDP and at the adjacent WKWMA.

**Table D.2. Wildlife Species Present or Potentially Present at the PGDP Site\***

<b>Common Name</b>	<b>Scientific Name</b>
<b><i>Fish</i></b>	
Black buffalo	<i>Ictiobus niger</i>
Blackspotted topminnow	<i>Fundulus olivaceus</i>
Creek chub	<i>Semotilus atromaculatus</i>
Bluegill sunfish	<i>Lepomis macrochirus</i>
Green sunfish	<i>Lepomis cyanellus</i>
Redspotted sunfish	<i>Lepomis miniatus</i>
Largemouth bass	<i>Micropterus salmoides</i>
Longear sunfish	<i>Lepomis megalotis</i>
Stoneroller	<i>Campostoma sp.</i>
<b><i>Reptiles and Amphibians</i></b>	
American toad	<i>Bufo americanus</i>
Bull frog	<i>Rana catesbeiana</i>
Eastern box turtle	<i>Terrapene carolina</i>
Leopard frog	<i>Rana sphenoccephala</i>
Salamanders	Various species
Snakes	Various species
Green treefrog	<i>Hyla cinerea</i>
Woodhouse toad	<i>Bufo woodhousei</i>
Northern Crawford frog	<i>Rana areolata circulosa</i>
Green frog	<i>Rana clamitans melanota</i>
Upland chorus frog	<i>Pseudacris triseriata ferriarum</i>
<b><i>Birds</i></b>	
American robin	<i>Turdus migratorius</i>
American woodcock	<i>Scolopax minor</i>
Bald eagle	<i>Haliaeetus leucocephalus</i>
Barred owl	<i>Strix varia</i>
Belted kingfisher	<i>Ceryle alcyon</i>
Blue jay	<i>Cyanocitta cristata</i>
Blue-winged teal	<i>Anas discors</i>
Canada goose	<i>Branta canadensis</i>
Coot	<i>Fulica americana</i>
American crow	<i>Corvus brachyrhynchos</i>
Downy woodpecker	<i>Picoides pubescens</i>
Eastern bluebird	<i>Sialia sialis</i>
Eastern kingbird	<i>Tyrannus tyrannus</i>
Eastern meadowlark	<i>Sturnella magna</i>
Eastern phoebe	<i>Sayornis phoebe</i>
Eastern wood pewee	<i>Contopus virens</i>
Gadwall duck	<i>Anas strepera</i>
Great blue heron	<i>Ardea herodias</i>
Great crested flycatcher	<i>Myiarchus crinitus</i>
Great-horned owl	<i>Bubo virginianus</i>
Hairy woodpecker	<i>Picoides villosus</i>
Hawks	Various species
Herons and egrets	Various species
Killdeer	<i>Charadrius vociferus</i>
Loggerhead shrike	<i>Lanius ludovicianus</i>
Mallard duck	<i>Anas platyrhynchos</i>
Mourning dove	<i>Zenaida macroura</i>
Northern bobwhite (aka bobwhite quail)	<i>Colinus virginianus</i>
Northern cardinal	<i>Cardinalis cardinalis</i>

**Table D.2. Wildlife Species Present or Potentially Present  
at the PGDP Site\* (Continued)**

<b>Common Name</b>	<b>Scientific Name</b>
<b><i>Bird (Continued)</i></b>	
Northern flicker	<i>Colaptes auratus</i>
Pileated woodpecker	<i>Dryocopus pileatus</i>
Red-bellied woodpecker	<i>Melanerpes erythrocephalus</i>
Red-shouldered hawk	<i>Buteo lineatus</i>
Red-tailed hawk	<i>Buteo jamaicensis</i>
Red-winged blackbird	<i>Agelaius phoeniceus</i>
Ruby-throated hummingbird	<i>Archilochus colubris</i>
Screech owl	<i>Megascops asio</i>
Song sparrow	<i>Melospiza melodia</i>
Swallows	Various species
Vireos	Various vireo sp.
Tufted titmouse	<i>Baeolophus bicolor</i>
Turkey vulture	<i>Cathartes aura</i>
Warblers	Various species
Chuck-will's widow	<i>Caprimulgus carolinensis</i>
White-breasted nuthatch	<i>Sitta carolinensis</i>
Whip-poor-will	<i>Caprimulgus vociferous</i>
Wild turkey	<i>Meleagris gallopavo</i>
Wood cock	<i>Scolopax minor</i>
Wood duck	<i>Aix sponsa</i>
Wrens	Various species
Yellow-billed cuckoo	<i>Coccyzus americanus</i>
<b><i>Mammals</i></b>	
American beaver	<i>Castor canadensis</i>
American mink (aka mink)	<i>Mustela vison</i>
Bobcat	<i>Lynx rufus</i>
Common muskrat	<i>Ondatra zibethicus</i>
Coyote	<i>Canis latrans</i>
Eastern cottontail	<i>Sylvilagus floridanus</i>
Eastern grey squirrel and fox squirrel	<i>Sciurus carolinensis</i>
Evening bat	<i>Nycticeius humeralis</i>
Groundhog	<i>Marmota monax</i>
Indiana bat	<i>Myotis sodalis</i>
Mice	Various species
Moles	Various species
Opposum	<i>Didelphis virginiana</i>
Raccoon	<i>Procyon lotor</i>
Red fox	<i>Vulpes vulpes</i>
Grey fox	<i>Urocyon cinereoargenteus</i>
Shrews	Various species
Skunk	<i>Mephitis mephitis</i>
Southeastern myotis bat	<i>Myotis sodalis</i>
Voles	Various species
White-tailed deer	<i>Odocoileus virginianus</i>

\*The listed species are from the Surface Water Operable Unit Report (DOE 2008) and the WKWMA species information Web site (<http://fw.ky.gov/kfwis/arcims/WmaSpecies.asp?strID=137>).

A number of state and federal listed, threatened, and endangered species may be present on the buffer areas within PGDP and the surrounding WKWMA land, though they are unlikely to be found on the maintained surface within SWMU 4 (DOE 2008). These species are listed in Table D.3 of this document.

**Table D.3. Federally Listed, Proposed, and Candidate Species Potentially Occurring within the Paducah Site Study Area<sup>a</sup>**

<b>Group</b>	<b>Common Name</b>	<b>Scientific Name</b>	<b>Endangered Species Act Status</b>
Mammals	Indiana Bat	<i>Myotis sodalis</i>	Endangered
	Northern Long-eared Bat	<i>Myotis septentrionalis</i>	Proposed
Mussels	Fanshell	<i>Cyprogenia stegaria</i>	Endangered
	Pink Mucket	<i>Lampsilis abrupta</i>	Endangered
	Ring Pink	<i>Obovaria retusa</i>	Endangered
	Orangefoot Pimpleback	<i>Plethobasus cooperianus</i>	Endangered
	Clubshell	<i>Pleurobema clava</i>	Endangered
	Rough Pigtoe	<i>Pleurobema plenum</i>	Endangered
	Fat Pocketbook	<i>Potamilus capax</i>	Endangered
	Spectaclecase	<i>Cumberlandia monodonta</i>	Endangered
	Sheepnose	<i>Plethobasus cyphyus</i>	Endangered
	Rabbitsfoot	<i>Quadrula c. cylindrical</i>	Threatened
Birds	Interior Least Tern	<i>Sterna antillarum athalassos</i>	Endangered

<sup>a</sup>All of the listed species are identified as an Endangered, Threatened, or Candidate Species known or with the potential to be located within McCracken County, Kentucky, by the U.S. Fish and Wildlife Service (November 2013). None of these species have been identified within the DOE property boundary.

### D.2.1.2 Data

The data set for surface and shallow subsurface soils (i.e., 0–5 ft bgs) used in the SERA is comprised of historical sampling events as well as data collected during sampling for this addendum (DOE 2014). Chapters 1 and 4 describe the data set used for SWMU 4. Appendix B addresses data quality and applicability of the historical data. A summary of the data is provided in Attachment D2.

For purposes of this SERA, high molecular weight polycyclic aromatic hydrocarbons (PAHs) consist of the following: benz(a)anthracene; benzo(a)pyrene; benzo(b)fluoranthene; benzo(k)fluoranthene; chrysene; dibenz(a,h)anthracene; fluoranthene; indeno(1,2,3-cd)pyrene; and pyrene. Low molecular weight PAHs consist of acenaphthene, acenaphthylene, anthracene, fluorene, naphthalene, and phenanthrene. Results of analyses for the PAHs are summed and assessed within the group (i.e., high molecular weight PAHs and low molecular weight PAHs). Individual PAHs are not assessed.

### D.2.1.3 Site Contaminants

Only surface and shallow subsurface soil (i.e., 0–5 ft bgs) contaminants at SWMU 4 were considered in the SERA. Site contaminants included inorganic chemicals, organic chemicals, and radionuclides.

### D.2.1.4 Fate and Transport Mechanisms

Potential migration pathways for contaminants from soil at SWMU 4 include transport of contaminated surface soil off-site by surface water, migration of contaminants to the subsurface soil, migration to groundwater, and uptake of soil contaminants through the on-site food chain. In addition, subsurface contaminants may be brought to the surface through bioturbation by burrowing animals or uptake by vegetation on the site. Migration of contaminants through these pathways is not considered significant and is not evaluated within this SERA.

The surface soils at SWMU 4 are held in place by vegetation. Transport of surface soil off-site is likely to be minimal. Migration of contaminants from subsurface soil and groundwater to an exposure media for ecological receptors is not likely to occur at SWMU 4; though contaminants in groundwater may be discharged to surface water at areas away from SWMU 4. Contaminants in surface soil are likely to be

taken up into plants and soil invertebrates at these sites and would enter higher trophic level organisms through the food chain.

## **D.2.2 POTENTIALLY COMPLETE EXPOSURE PATHWAYS**

The potential exposure pathways for ecological receptors are direct contact with and ingestion of soil and ingestion of plants or animals thereby exposed to substances in soil. Significant contaminant transport through runoff directly to surface water is unlikely because most of SWMU 4 has a vegetated surface. The pathways through which receptors could contact contaminants in surface soil include direct ingestion of soil, ingestion of plant or animals from the site as food, external exposure to ionizing radiation, and dermal contact with soil or surface water. A CSM reflective of current site conditions is shown in Figure D.2. This SERA evaluates ecological risks associated with surface and shallow subsurface soil (i.e., 0–5 ft bgs) only.

## **D.2.3 POTENTIALLY CONTAMINATED MEDIA**

Soil is the media of concern for SWMU 4. The substances detected in surface soils [metals, radionuclides, semivolatile organic compounds (SVOCs), and volatile organic compounds (VOCs)] are capable of causing adverse effects to terrestrial receptors. This SERA evaluates only terrestrial receptors (see Section D.2.1) for chemicals or radionuclides of potential ecological concern (COPECs).

Significant surface water contamination is not expected based on evaluations previously performed at other SWMUs within the site (UK 2007). As a result, ecological risks associated with exposure to surface water were not assessed in this SERA.

## **D.3. SCREENING-LEVEL EFFECTS EVALUATION**

For SWMU 4, the maximum site concentration of the reported values of each potential contaminant was compared to a single ecological screening level selected from the Ecological Risk Methods Document. ESVs were taken from Tables A.2 and A.3 of the Ecological Risk Methods Document (DOE 2015b). These ESVs are the PGDP no further action (NFA) values for soil. For detected radiological results for which no ESV was available in the Ecological Risk Methods Document, one was calculated following similar methodology. Additionally, for detected chemicals for which an ESV is not listed in Table A.2, values from other sources were used. These values are presented in Attachment D1.

The maximum site concentration for a substance reported as detected in any sample is the larger of the maximum detected concentration and one half of the maximum reported detection limit for the substance in samples reported as nondetect. Maximum detected site concentrations, frequencies of detection and detection limit ranges are provided in Attachment D2. The maximum site concentration was used to calculate a screening HQ, using a ratio of the maximum site concentration with the ESV, as shown below:

$$\text{HQ} = \frac{\text{EPC}}{\text{ESV}}$$

A total screening HI then was calculated by summing the screening HQs within the SWMU. Priority COPECs were selected from the chemicals at the SWMU showing the screening HQs greater than 10. “Priority COPECs” are identified in this addendum as an aid to risk managers during decision making.

Table D.1 summarized these values. Background values from the Risk Methods Document (DOE 2015a) also are shown for comparison.

As shown, SWMU 4 had one or more COPECs retained. The entire screening list is provided in Attachment D2. COPECs are listed below.

Metals:

- Aluminum
- Arsenic
- Barium
- Cadmium
- Calcium (retained because no ESV was available)
- Chromium
- Copper
- Iron
- Lead
- Manganese
- Mercury
- Molybdenum
- Nickel
- Potassium (retained because no ESV was available)
- Silver
- Sodium (retained because no ESV was available)
- Uranium
- Vanadium
- Zinc

Polychlorinated biphenyls (PCBs)

SVOCs:

- Bis(2-ethylhexyl)phthalate
- High molecular weight PAHs

Radionuclides:

- Protactinium-234m (retained because no ESV was available)
- Thorium-234 (retained because no ESV was available)

## **D.4. UNCERTAINTIES**

A number of uncertainties impact the potential usefulness of the results of this SERA. An uncertainty in these screening assessments is that the ecological screening levels are protective of entire suites of receptors, some of which may not be present at these disturbed sites. The grassy areas of these sites would be attractive to ecological receptors, but the surrounding industrial area may limit the extent to which ecological receptors use these areas.



Because no pH data are available for SWMU 4 soils, aluminum has been evaluated as if pH were less than 5.5. While soils in the vicinity of PGDP tend to have a low pH, ranging from 4.5 to 5.5 (DOE 1999), the pH of the soils for SWMU 4 is unknown. Aluminum subsequently may be evaluated further by collection of soil pH data. Because soil pH results can be variable, however, whether aluminum should be considered a COPEC at SWMU 4 is an uncertainty. Additionally, a number of chemicals were retained as COPECs for which no benchmarks were available. These chemicals, upon further evaluation, may have no negative impacts on the ecological receptors.

These uncertainties, combined with the results of the SERA, indicate the need for further evaluation of SWMU 4. Risk managers may determine that the site does not need further evaluation (if exposure pathways are not complete or planned actions will eliminate the exposure pathway) or may recommend additional evaluation of the site to define better the potential ecological risk indicated by the results. Alternatively, the benchmarks used in the screenings presented here and in the NFA levels in the PGDP Ecological Risk Methods Document (DOE 2015b) may be used as the ecologically based remedial goal options.

## D.5. CONCLUSIONS

SWMU 4 retained a number of COPECs including metals, PCBs, SVOCs, and Rads. A summary of the results of the site data is provided in Table D.4, which lists the number of COPECs within each analytical suite [i.e., metals, radiological constituents, PCBs, SVOCs, and VOCs] retained for SWMU 4 for further consideration.

**Table D.4. Summary of Suite of COPECs Retained in Surface Soil and Shallow Subsurface Soil (0–5 ft bgs)**

SWMU	Media	Number of Metals	Number of Rads	Number of PCBs	Number of SVOCs	Number of VOCs
4	Soil	19	2	1	2	0

Further, the following COPECs had a screening HQ, based on exposure point concentration, above 10: aluminum, cadmium, chromium, iron, manganese, mercury, uranium, Total PCBs, and high molecular weight PAHs. These COPECs are listed in Table D.1.

## D.6. REFERENCES

DOE (U.S. Department of Energy) 2008. *Surface Water Operable Unit (On-Site) Site Investigation and Baseline Risk Assessment Report at the Paducah Gaseous Diffusion Plant, Paducah, Kentucky*, DOE/LX/07-001&D2/R1, U.S. Department of Energy, Paducah, KY, February.

DOE 2015a. *Methods for Conducting Risk Assessments and Risk Evaluations at the Paducah Gaseous Diffusion Plant Paducah, Kentucky*, Volume 1, *Human Health*, DOE/LX/07-0107/D2/R6&V1, U.S. Department of Energy, Paducah, KY, July.

DOE 2015b. *Methods for Conducting Risk Assessments and Risk Evaluations at the Paducah Gaseous Diffusion Plant Paducah, Kentucky*, Volume 2, *Ecological*, DOE/LX/07-0107&D2/R1/V2, U.S. Department of Energy, Paducah, KY, January.

UK (University of Kentucky) 2007. *Assessment of Radiation in Surface Water at the Paducah Gaseous Diffusion Plant*, Radiation Health Branch, Division of Public Health Protection and Safety, Department for Public Health, Cabinet for Health and Family Services, Frankfort, KY, January.

**ATTACHMENT D1**  
**ADDITIONAL ESVS**

**THIS PAGE INTENTIONALLY LEFT BLANK**

For detected radiological results for which no ecological screening value (ESV) was available for no further action (NFA) in the Ecological Risk Methods Document, one was calculated following similar methodology (DOE 2015b). These ESVs are presented in Table D1.1.

**Table D1.1. PGDP Soil NFA Screening Values for Additional Radionuclides**

<b>Radionuclide</b>	<b>NFA (pCi/g)</b>
Radium-226	2.88E+01
Thorium-228	5.30E+02
Thorium-232	1.52E+03

NFA = activity (pCi/g) resulting in dose of 0.1 rad/day assuming secular equilibrium of parent and daughter products.

NFA values are from RESRAD-BIOTA, Version 1.5, Report for Level 2 (default values, except dose adjusted to 0.1 rad/day) RESRAD-BIOTA software is available at

<http://web.ead.anl.gov/resrad/home2/biota.cfm>.

Detected chemicals for which an ESV is not listed in Table A.2 of the Ecological Risk Methods Document, values from other sources were used. These values are presented in Table D1.2.

**Table D1.2. PGDP Soil NFA Screening Values for Additional Chemicals**

<b>Analyte</b>	<b>PGDP NFA Screening Value (mg/kg)</b>	<b>Source for Screening Value</b>
Magnesium	4.40E+05	KDEP <sup>a</sup>
Iron	2.00E+02	KDEP <sup>a</sup>
Bis(2-ethylhexyl)phthalate	1.82E-01	DOE <sup>b</sup>
Methylene chloride	2.00E+00	KDEP <sup>a</sup>

<sup>a</sup> Kentucky ESVs are provided in Appendix F of the Ecological Risk Methods Document (DOE 2015b).

<sup>b</sup> ESVs for sediment used [Table A.4 of the Ecological Risk Methods Document (DOE 2015b)] because a value was not available for soil.

**THIS PAGE INTENTIONALLY LEFT BLANK**

**ATTACHMENT D2**

**SWMU 4 DATA SUMMARY AND ECOLOGICAL SCREENING**

**THIS PAGE INTENTIONALLY LEFT BLANK**



**Table D2.1. Data Summary of SWMU 4 Surface Soil and Shallow Subsurface Soil (0–5 ft bgs)**

Analysis	Detected Results			Frequency of Detection	Detection Limit Range
	Min	Max	Avg		
<b>Metals (mg/kg)</b>					
Aluminum	3.32E+03	1.63E+04	9.53E+03	20/20	18.2–20
Antimony	N/A	N/A	N/A	0/20	9.08–20
Arsenic	1.30E+00	2.94E+01	7.13E+00	157/205	0.92–5
Barium	1.21E+01	4.89E+02	2.72E+02	192/205	0.515–10
Beryllium	5.10E-01	2.45E+00	7.98E-01	26/60	0.45–0.632
Cadmium	5.97E-01	1.56E+01	1.67E+00	14/205	0.515–6
Calcium	8.39E+01	1.22E+05	9.33E+03	20/20	50–926
Chromium	4.33E+00	2.96E+02	4.73E+01	180/205	1.03–5
Cobalt	3.06E+00	1.30E+01	5.74E+00	20/20	1–2.44
Copper	6.57E+00	5.81E+01	1.57E+01	20/20	2–2.44
Cyanide	N/A	N/A	N/A	0/16	1–1
Iron	4.57E+03	1.25E+05	1.42E+04	205/205	5–112
Lead	5.25E+00	1.06E+02	2.01E+01	189/205	1.03–20
Magnesium	2.70E+02	3.51E+03	1.31E+03	20/20	4.54–15
Manganese	1.95E+01	4.47E+04	6.60E+02	205/205	1–115
Mercury	2.00E-02	1.00E+01	9.48E-01	41/201	0.017–2
Molybdenum	7.05E+00	7.05E+00	7.05E+00	1/4	4.54–4.88
Nickel	5.03E+00	1.82E+02	2.86E+01	101/205	1.03–10.7
Potassium	1.89E+02	9.43E+02	5.63E+02	20/20	90.8–100
Selenium	N/A	N/A	N/A	0/205	1–19.5
Silver	1.70E+01	3.70E+01	2.32E+01	26/205	1.03–6
Sodium	1.12E+02	3.64E+02	2.81E+02	9/20	90.8–200
Thallium	N/A	N/A	N/A	0/20	15–19.5
Uranium	1.39E+00	2.84E+03	3.69E+02	107/189	0.13–115
Vanadium	4.47E+00	6.57E+01	2.16E+01	60/60	2–2.53
Zinc	2.74E+01	1.32E+02	5.09E+01	19/20	15–19.5
<b>PCBs (mg/kg)</b>					
PCB, Total	2.60E-02	2.22E+02	6.60E+00	105/254	0.1–12.4
<b>SVOCs (mg/kg)</b>					
1,2,4-Trichlorobenzene	N/A	N/A	N/A	0/13	0.41–0.5
1,2-Dichlorobenzene	N/A	N/A	N/A	0/13	0.41–0.5
1,3-Dichlorobenzene	N/A	N/A	N/A	0/13	0.41–0.5
1,4-Dichlorobenzene	N/A	N/A	N/A	0/13	0.41–0.5
2,4,5-Trichlorophenol	N/A	N/A	N/A	0/13	0.41–0.5
2,4,6-Trichlorophenol	N/A	N/A	N/A	0/13	0.41–0.5
2,4-Dichlorophenol	N/A	N/A	N/A	0/13	0.41–0.5
2,4-Dimethylphenol	N/A	N/A	N/A	0/13	0.41–0.5
2,4-Dinitrophenol	N/A	N/A	N/A	0/7	0.41–0.5
2,4-Dinitrotoluene	N/A	N/A	N/A	0/13	0.41–0.5
2,6-Dinitrotoluene	N/A	N/A	N/A	0/13	0.41–0.5
2-Chloronaphthalene	N/A	N/A	N/A	0/13	0.41–0.5
2-Chlorophenol	N/A	N/A	N/A	0/13	0.41–0.5
2-Methyl-4,6-dinitrophenol	N/A	N/A	N/A	0/13	0.41–0.5
2-Methylnaphthalene	N/A	N/A	N/A	0/13	0.41–0.5
2-Methylphenol	N/A	N/A	N/A	0/13	0.41–0.5
2-Nitrobenzenamine	N/A	N/A	N/A	0/53	0.41–0.66
2-Nitrophenol	N/A	N/A	N/A	0/13	0.41–0.5
3,3'-Dichlorobenzidine	N/A	N/A	N/A	0/13	0.41–0.5
3-Nitrobenzenamine	N/A	N/A	N/A	0/13	0.41–0.5
4-Bromophenyl phenyl ether	N/A	N/A	N/A	0/13	0.41–0.5
4-Chloro-3-methylphenol	N/A	N/A	N/A	0/13	0.41–0.5
4-Chlorobenzenamine	N/A	N/A	N/A	0/13	0.41–0.5
4-Chlorophenyl phenyl ether	N/A	N/A	N/A	0/13	0.41–0.5

**Table D2.1. Data Summary of SWMU 4 Surface Soil and Shallow Subsurface Soil (0–5 ft bgs) (Continued)**

Analysis	Detected Results			Frequency of Detection	Detection Limit Range
	Min	Max	Avg		
4-Methylphenol	N/A	N/A	N/A	0/13	0.41–0.5
4-Nitrophenol	N/A	N/A	N/A	0/13	0.41–0.5
Acenaphthene	N/A	N/A	N/A	0/57	0.41–0.66
Acenaphthylene	N/A	N/A	N/A	0/57	0.41–0.66
Anthracene	N/A	N/A	N/A	0/57	0.41–0.66
Benz(a)anthracene	8.00E-01	1.10E+00	9.50E-01	2/57	0.41–0.66
Benzo(a)pyrene	7.50E-01	1.30E+00	1.03E+00	2/57	0.41–0.66
Benzo(b)fluoranthene	7.30E-01	2.30E+00	1.38E+00	3/57	0.41–0.66
Benzo(ghi)perylene	N/A	N/A	N/A	0/17	0.41–0.5
Benzo(k)fluoranthene	9.10E-01	9.10E-01	9.10E-01	1/57	0.41–0.66
Bis(2-chloroethoxy)methane	N/A	N/A	N/A	0/13	0.41–0.5
Bis(2-chloroethyl) ether	N/A	N/A	N/A	0/13	0.41–0.5
Bis(2-chloroisopropyl) ether	N/A	N/A	N/A	0/13	0.41–0.5
Bis(2-ethylhexyl)phthalate	2.51E-01	2.51E-01	2.51E-01	1/13	0.41–0.5
Butyl benzyl phthalate	N/A	N/A	N/A	0/7	0.41–0.5
Carbazole	N/A	N/A	N/A	0/53	0.41–0.66
Chrysene	9.10E-01	1.30E+00	1.11E+00	2/57	0.41–0.66
Dibenz(a,h)anthracene	N/A	N/A	N/A	0/57	0.41–0.66
Dibenzofuran	N/A	N/A	N/A	0/13	0.41–0.5
Diethyl phthalate	N/A	N/A	N/A	0/13	0.41–0.5
Dimethyl phthalate	N/A	N/A	N/A	0/13	0.41–0.5
Di-n-butyl phthalate	6.00E-01	6.00E-01	6.00E-01	1/13	0.41–0.5
Di-n-octylphthalate	N/A	N/A	N/A	0/13	0.41–0.5
Fluoranthene	8.40E-01	2.90E+00	1.81E+00	3/57	0.41–0.66
Fluorene	N/A	N/A	N/A	0/17	0.41–0.5
Hexachlorobenzene	N/A	N/A	N/A	0/53	0.41–0.66
Hexachlorobutadiene	N/A	N/A	N/A	0/13	0.41–0.5
Hexachlorocyclopentadiene	N/A	N/A	N/A	0/13	0.41–0.5
Hexachloroethane	N/A	N/A	N/A	0/13	0.41–0.5
Indeno(1,2,3-cd)pyrene	5.90E-01	5.90E-01	5.90E-01	1/57	0.41–0.66
Isophorone	N/A	N/A	N/A	0/13	0.41–0.5
Naphthalene	N/A	N/A	N/A	0/57	0.41–0.66
Nitrobenzene	N/A	N/A	N/A	0/13	0.41–0.5
N-Nitroso-di-n-propylamine	N/A	N/A	N/A	0/53	0.41–0.66
N-Nitrosodiphenylamine	N/A	N/A	N/A	0/13	0.41–0.5
Pentachlorophenol	N/A	N/A	N/A	0/13	0.41–0.5
Phenanthrene	1.00E+00	1.40E+00	1.20E+00	2/57	0.41–0.66
Phenol	N/A	N/A	N/A	0/13	0.41–0.5
p-Nitroaniline	N/A	N/A	N/A	0/13	0.41–0.5
Pyrene	7.10E-01	2.00E+00	1.40E+00	3/57	0.41–0.66
Pyridine	N/A	N/A	N/A	0/3	0.41–0.47
<b>VOCs (mg/kg)</b>					
1,1,1-Trichloroethane	N/A	N/A	N/A	0/17	0.005–0.01
1,1,2,2-Tetrachloroethane	N/A	N/A	N/A	0/13	0.01–0.01
1,1,2-Trichloro-1,2,2-trifluoroethane	N/A	N/A	N/A	0/23	0.00459–0.0156
1,1,2-Trichloroethane	N/A	N/A	N/A	0/13	0.01–0.01
1,1-Dichloroethane	N/A	N/A	N/A	0/13	0.01–0.01
1,1-Dichloroethene	N/A	N/A	N/A	0/40	0.00459–0.519
1,2-Dichloroethane	N/A	N/A	N/A	0/13	0.01–0.01
1,2-Dichloropropane	N/A	N/A	N/A	0/13	0.01–0.01
1,2-Dimethylbenzene	N/A	N/A	N/A	0/36	0.00459–0.0156
2-Butanone	N/A	N/A	N/A	0/13	0.01–0.01
2-Hexanone	N/A	N/A	N/A	0/13	0.01–0.01
4-Methyl-2-pentanone	N/A	N/A	N/A	0/13	0.01–0.01

**Table D2.1. Data Summary of SWMU 4 Surface Soil and Shallow Subsurface Soil (0–5 ft bgs) (Continued)**

Analysis	Detected Results			Frequency of Detection	Detection Limit Range
	Min	Max	Avg		
Acetone	N/A	N/A	N/A	0/7	0.01–0.01
Acrylonitrile	N/A	N/A	N/A	0/23	0.00459–0.0156
Benzene	N/A	N/A	N/A	0/36	0.00459–0.0156
Bromodichloromethane	N/A	N/A	N/A	0/13	0.01–0.01
Bromoform	N/A	N/A	N/A	0/13	0.01–0.01
Bromomethane	N/A	N/A	N/A	0/13	0.01–0.01
Carbon disulfide	N/A	N/A	N/A	0/13	0.01–0.01
Carbon tetrachloride	N/A	N/A	N/A	0/36	0.00459–0.0156
Chlorobenzene	N/A	N/A	N/A	0/13	0.01–0.01
Chloroethane	N/A	N/A	N/A	0/13	0.01–0.01
Chloroform	N/A	N/A	N/A	0/36	0.00459–0.0156
Chloromethane	N/A	N/A	N/A	0/13	0.01–0.01
<i>cis</i> -1,2-Dichloroethene	N/A	N/A	N/A	0/40	0.00459–0.519
<i>cis</i> -1,3-Dichloropropene	N/A	N/A	N/A	0/13	0.01–0.01
Dibromochloromethane	N/A	N/A	N/A	0/13	0.01–0.01
Dichlorodifluoromethane	N/A	N/A	N/A	0/23	0.00459–0.0156
Ethylbenzene	N/A	N/A	N/A	0/36	0.00459–0.0156
<i>m,p</i> -Xylene	N/A	N/A	N/A	0/36	0.00918–0.0312
Methylene chloride	1.50E-02	4.90E-02	3.67E-02	3/13	0.01–0.01
Styrene	N/A	N/A	N/A	0/13	0.01–0.01
Tetrachloroethene	N/A	N/A	N/A	0/36	0.00459–0.0156
Toluene	N/A	N/A	N/A	0/36	0.00459–0.0156
Total Xylene	N/A	N/A	N/A	0/23	0.0138–0.0468
<i>trans</i> -1,2-Dichloroethene	N/A	N/A	N/A	0/17	0.01–0.519
<i>trans</i> -1,3-Dichloropropene	N/A	N/A	N/A	0/13	0.01–0.01
Trichloroethene	N/A	N/A	N/A	0/44	0.00459–0.519
Vinyl chloride	N/A	N/A	N/A	0/40	0.00459–0.519
<b>Radionuclides (pCi/g)</b>					
Alpha activity	1.23E+01	2.79E+02	4.94E+01	26/26	0.57–13
Americium-241	3.72E-02	6.49E-01	3.43E-01	2/73	0.02–15
Beta activity	1.94E+01	6.42E+02	7.60E+01	26/26	0.84–8.9
Cesium-137	3.32E-02	9.92E-01	2.70E-01	38/70	0.0246–3.5
Cobalt-60	N/A	N/A	N/A	0/70	0.0202–5.7
Neptunium-237	4.65E-02	4.72E+00	5.08E-01	33/61	0.03–0.112
Plutonium-238	5.01E-02	5.01E-02	5.01E-02	1/44	0.0141–0.0548
Plutonium-239/240	3.35E-02	4.05E+00	3.75E-01	23/61	0.02–0.086
Protactinium-234m	3.80E+02	3.80E+02	3.80E+02	1/20	23–500
Radium-226	7.85E-01	2.28E+00	1.62E+00	3/11	0.394–0.752
Technetium-99	1.09E+00	1.26E+02	1.38E+01	29/71	0.736–6.94
Thorium-228	1.82E-01	7.15E-01	4.97E-01	4/4	0.16–0.17
Thorium-230	6.20E-01	5.35E+01	3.43E+00	48/50	0.159–0.344
Thorium-232	1.48E-01	6.97E-01	4.78E-01	4/4	0.04–0.05
Thorium-234	3.24E+00	1.58E+02	5.10E+01	11/23	0.587–34
Uranium-234	6.97E-01	7.44E+01	1.01E+01	55/55	0.08–2.3
Uranium-235	3.40E-02	4.40E+00	5.83E-01	43/64	0.02–9.8
Uranium-238	8.63E-01	2.31E+02	2.12E+01	55/55	0.04–2.4

**Table D2.2. Ecological Screening**

<b>Analysis</b>	<b>Unit</b>	<b>Maximum Detection or <math>\frac{1}{2}</math> Maximum Detection Limit<sup>a</sup></b>	<b>Soil No Further Action Value</b>	<b>Screening Hazard Quotient<sup>b</sup></b>	<b>Retained as Chemical or Radionuclide of Potential Ecological Concern (COPEC)?</b>
<b><i>Metals</i></b>					
Aluminum	mg/kg	16300	50	326	Yes
Arsenic	mg/kg	29.4	18	2	Yes
Barium	mg/kg	489	330	1	Yes
Beryllium	mg/kg	2.45	2.5	< 1	No
Cadmium	mg/kg	15.6	0.36	43	Yes
Calcium	mg/kg	122000	N/A	*	Yes
Chromium	mg/kg	296	26	11	Yes
Cobalt	mg/kg	13	13	1	No
Copper	mg/kg	58.1	28	2	Yes
Iron	mg/kg	125000	200	625	Yes
Lead	mg/kg	106	11	10	Yes
Magnesium	mg/kg	3510	440000	< 1	No
Manganese	mg/kg	44700	220	203	Yes
Mercury	mg/kg	10	0.1	100	Yes
Molybdenum	mg/kg	7.05	2	4	Yes
Nickel	mg/kg	182	38	5	Yes
Potassium	mg/kg	943	N/A	*	Yes
Silver	mg/kg	37	4.2	9	Yes
Sodium	mg/kg	364	N/A	*	Yes
Uranium	mg/kg	2840	5	568	Yes
Vanadium	mg/kg	65.7	7.8	8	Yes
Zinc	mg/kg	132	46	3	Yes
<b><i>PCBs</i></b>					
PCB, Total	mg/kg	222	0.02	11100	Yes
<b><i>SVOCs</i></b>					
Bis(2-ethylhexyl)phthalate	mg/kg	0.25	0.182	1	Yes
Di-n-butyl phthalate	mg/kg	0.6	200	< 1	No
High molecular weight PAHs	mg/kg	12.14	1.1	11	Yes
Low molecular weight PAHs	mg/kg	1.4	29	< 1	No
<b><i>VOCs</i></b>					
Methylene chloride	mg/kg	0.049	2	< 1	No

**Table D2.2. Ecological Screening (Continued)**

<b>Analysis</b>	<b>Unit</b>	<b>Maximum Detection or 1/2 Maximum Detection Limit<sup>a</sup></b>	<b>Soil No Further Action Value</b>	<b>Screening Hazard Quotient<sup>b</sup></b>	<b>Retained as Chemical or Radionuclide of Potential Ecological Concern (COPEC)?</b>
<b><i>Radionuclides</i></b>					
Americium-241	pCi/g	7.5	2160	< 1	No
Cesium-137	pCi/g	1.75	20.8	< 1	No
Neptunium-237	pCi/g	4.72	814	< 1	No
Plutonium-238	pCi/g	0.0501	1750	< 1	No
Plutonium-239/240	pCi/g	4.05	1270	< 1	No
Protactinium-234m	pCi/g	250	N/A	*	Yes
Radium-226	pCi/g	1.265	28.8	< 1	No
Technetium-99	pCi/g	126	2190	< 1	No
Thorium-228	pCi/g	0.715	530	< 1	No
Thorium-230	pCi/g	53.5	9980	< 1	No
Thorium-232	pCi/g	0.697	1520	< 1	No
Thorium-234	pCi/g	158	N/A	*	Yes
Uranium-234	pCi/g	74.4	5140	< 1	No
Uranium-235	pCi/g	4.9	2750	< 1	No
Uranium-238	pCi/g	231	1570	< 1	No
<b>Total</b>				<b>13035</b>	

<sup>a</sup> The screening values were selected from the surface and shallow subsurface data set (0–5 ft bgs).

<sup>b</sup> Screening hazard quotient marked as “\*” indicates that currently there is no soil no further action value for this chemical or radionuclide; therefore, it has been retained as a COPEC.

**THIS PAGE INTENTIONALLY LEFT BLANK**

**APPENDIX E**

**SWMU 4 TEST PIT PHOTOGRAPHS**

**THIS PAGE INTENTIONALLY LEFT BLANK**



**Photographic Record**  
**SWMU 4    Test Pit #1    January 28, 2016**

**Photo #:** P1000032

**Date:** 01/28/2016

**Direction:** Unknown

**Comments:** This photo shows topsoil and the underlying white clay cap as excavation begins.



**Photo #:** P1000041

**Date:** 01/28/2016

**Direction:** Unknown

**Comments:** This photo shows a container, drum rings and miscellaneous unidentified metal debris.



**Photographic Record**  
**SWMU 4    Test Pit #1    January 28, 2016**

**Photo #:** P1000051

**Date:** 01/28/2016

**Direction:** Looking northwestward

**Comments:** This photo shows drums in various states of degradation/corrosion; it also shows miscellaneous unidentified metal debris.



**Photo #:** P1000061

**Date:** 01/28/2016

**Direction:** Looking downward

**Comments:** This photo shows a metal container (cask) and the open lid. There is no evidence of material inside container.



**Photographic Record**  
**SWMU 4    Test Pit #2    February 3, 2016**

**Photo #:** P1000147

**Date:** 02/03/2016

**Direction:** Looking  
northeastward

**Comments:** This photo  
shows white clay cap  
being removed from Test  
Pit #2.



**Photo #:** P1000177

**Date:** 02/03/2016

**Direction:** Looking  
downward

**Comments:** This photo  
shows equipment part with  
an illegible name plate.



**Photographic Record**  
**SWMU 4    Test Pit #2    February 3, 2016**

**Photo #:** P1000179

**Date:** 02/03/2016

**Direction:** Looking eastward

**Comments:** This photo shows several miscellaneous metal parts and many welding rods.



**Photo #:** P1000184

**Date:** 02/03/2016

**Direction:** Looking northeastward

**Comments:** This photo shows pieces of metal roofing and pieces of pipe and other unidentified metal debris.



**Photographic Record**  
**SWMU 4    Test Pit #2    February 3, 2016**

**Photo #:** P1000186

**Date:** 02/03/2016

**Direction:** Looking eastward

**Comments:** This photo shows welding rods and miscellaneous unidentified metal debris.



**Photo #:** P1000209

**Date:** 02/03/2016

**Direction:** Looking northeastward

**Comments:** This photo shows a variety of unidentified metal debris and water dipped from Test Pit #2.



**Photographic Record**

**SWMU 4    Test Pit #2    February 3, 2016**

**Photo #:** P1000217

**Date:** 02/03/2016

**Direction:** Looking downward and northeastward

**Comments:** This photo shows a variety of unidentified metal debris in the sidewalls of Test Pit #2 and groundwater in the bottom of the test pit. Also pictured here is a geotextile material encountered near the ground surface.



**Photographic Record**  
**SWMU 4    Test Pit #3    February 1, 2016**

**Photo #:** P1000079

**Date:** 02/01/2016

**Direction:** Looking westward

**Comments:** This photo shows a thin layer of white clay cap as excavation begins.



**Photo #:** P1000104

**Date:** 02/01/2016

**Direction:** Looking westward

**Comments:** This photo shows a white, unidentified earth-like material and scattered unidentified construction debris.



**Photographic Record**  
**SWMU 4    Test Pit #3    February 1, 2016**

**Photo #:** P1000109

**Date:** 02/01/2016

**Direction:** Looking westward

**Comments:** This photo shows a variety of unidentified metal debris.



**Photo #:** P1000112

**Date:** 02/01/2016

**Direction:** Looking westward

**Comments:** This photo shows metal containers, copper tubing, and metal rods.





**Photographic Record**  
**SWMU 4    Test Pit #3    February 1, 2016**

**Photo #:** P1000121

**Date:** 02/01/2016

**Direction:** Looking westward

**Comments:** This photo shows several drum rings and other unidentified metal debris.



**Photo #:** P1000140

**Date:** 02/01/2016

**Direction:** Looking northwestward

**Comments:** This photo shows the closure of Test Pit #3.



**Photographic Record**  
**SWMU 4    Test Pit #4    March 4, 2016**

**Photo #:** P1000349

**Date:** 03/04/2016

**Direction:** Looking southwestward

**Comments:** This photo shows unidentified scrap metal.



**Photo #:** P1000373

**Date:** 03/04/2016

**Direction:** Looking northwestward

**Comments:** This photo shows a variety of unidentified scrap metal and debris.



**Photographic Record**  
**SWMU 4    Test Pit #4    March 4, 2016**

**Photo #:** P1000392

**Date:** 03/04/2016

**Direction:** Looking downward

**Comments:** This photo shows a stainless steel pipe and valve and other unidentified scrap metal.



**Photo #:** P1000393

**Date:** 03/04/2016

**Direction:** Looking downward

**Comments:** This photo shows a variety of unidentified scrap metal, debris, and groundwater in Test Pit #4.



**Photographic Record**  
**SWMU 4    Test Pit #5    February 4, 2016**

**Photo #:** P1000242

**Date:** 02/04/2016

**Direction:** Looking downward

**Comments:** This photo shows smelted material inside a damaged mold undergoing a radiological survey.



**Photo #:** P1000245

**Date:** 02/04/2016

**Direction:** Looking downward to the west

**Comments:** This photo shows a damaged stainless steel vent hood.



**Photographic Record**  
**SWMU 4    Test Pit #5    February 4, 2016**

**Photo #:** P1000249

**Date:** 02/04/2016

**Direction:** Looking downward to the west

**Comments:** This photo shows a stainless steel vent hood and a large unidentified piece of scrap metal undergoing radiological survey.



**Photo #:** P1000267

**Date:** 02/04/2016

**Direction:** Unknown

**Comments:** This photo shows a damaged metal mold.



**Photographic Record**  
**SWMU 4    Test Pit #5    March 2, 2016**

**Photo #:** P1000279

**Date:** 03/02/2016

**Direction:** Looking southwestward

**Comments:** This photo shows a glass bottle, drum lids, pipe, and unidentified miscellaneous metal debris.



**Photo #:** P1000309

**Date:** 03/02/2016

**Direction:** Looking southwestward

**Comments:** This photo shows drums, pipe, and unidentified metal debris.



**Photographic Record**  
**SWMU 4 Test Pit #5 March 2, 2016**

**Photo #:** P1000327

**Date:** 03/02/2016

**Direction:** Looking westward

**Comments:** This photo shows drums, pipe, wire, metal debris, and groundwater from Test Pit #5.



**Photo #:** P1000339

**Date:** 03/02/2016

**Direction:** Looking downward to the west

**Comments:** This photo is inside of Test Pit #5; it shows groundwater, glass bottles, and unidentified metal debris.



**Photographic Record**  
**SWMU 4    Test Pit #5    March 2, 2016**

**Photo #:** P1000345

**Date:** 03/02/2016

**Direction:** Looking  
northwestward

**Comments:** This photo shows  
the closure of Test Pit #5.





**Photographic Record**  
**SWMU 4    Test Pit #6    March 7, 2016**

**Photo #:** P1000402

**Date:** 03/07/2016

**Direction:** Looking southeastward

**Comments:** This photo shows the excavator digging to its maximum depth.



**Photo #:** P1000406

**Date:** 03/07/2016

**Direction:** Looking eastward

**Comments:** This photo shows a soil pile with miscellaneous unidentified metal scattered throughout.



**Photographic Record**  
**SWMU 4    Test Pit #6    March 8, 2016**

**Photo #:** P1000410

**Date:** 03/08/2016

**Direction:** Looking  
northeastward

**Comments:** This photo shows  
miscellaneous unidentified  
debris and groundwater inside  
Test Pit #6.



**Photo #:** P1000418

**Date:** 03/08/2016

**Direction:** Looking  
northeastward

**Comments:** This photo shows  
the groundwater, drums and  
miscellaneous unidentified  
debris inside of Test Pit #6.



**Photographic Record**  
**SWMU 4    Test Pit #6    March 8, 2016**

**Photo #:** P1000444

**Date:** 03/08/2016

**Direction:** Looking  
northeastward

**Comments:** This photo shows a  
soil pile with miscellaneous  
unidentified metal scattered  
throughout.



**THIS PAGE INTENTIONALLY LEFT BLANK**

## **CD DATA**

**Attachment A1: SWMU 4 Monitoring Well Logs**

**Attachment A2: SWMU 4 Test Pit Records**

**Attachment A3: SWMU 4 Engineering and Design Samples**

**Attachment A4: SWMU 4 Borehole Logs**

**Appendix B: Analytical Data**

**Attachment B1: XRF Statistics**

**Attachment C1: PROUCL Output for Soils**

**Attachment C2: PROUCL Output for Groundwater**

**THIS PAGE INTENTIONALLY LEFT BLANK**

**CERTIFICATION**

**Document Identification:** *Addendum to the Remedial Investigation Report for the Burial Grounds Operable Unit Solid Waste Management Unit 4 at the Paducah Gaseous Diffusion Plant, Paducah, Kentucky, DOE/LX/07-0030&D2/R1/A1/R2, April 2017*

I certify under penalty of law that this document and all attachments were prepared under my direction or supervision in accordance with a system designed to ensure that qualified personnel properly gather and evaluate the information submitted. Based on my inquiry of the person or persons directly responsible for gathering the information, the information submitted is, to the best of my knowledge and belief, true, accurate, and complete. I am aware that there are significant penalties for submitting false information, including the possibility of fine and imprisonment for knowing violations.

Fluor Federal Services, Inc.



Myrna E. Redfield, Director, Environmental Management

4/12/17  
Date Signed

I certify under penalty of law that this document and all attachments were prepared under my direction or supervision in accordance with a system designed to ensure that qualified personnel properly gather and evaluate the information submitted. Based on my inquiry of the person or persons directly responsible for gathering the information, the information submitted is, to the best of my knowledge and belief, true, accurate, and complete. I am aware that there are significant penalties for submitting false information, including the possibility of fine and imprisonment for knowing violations.

U.S. Department of Energy

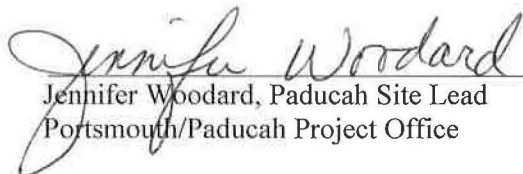

Jennifer Woodard, Paducah Site Lead  
Portsmouth/Paducah Project Office

4/12/2017  
Date Signed