



Department of Energy

Portsmouth/Paducah Project Office
1017 Majestic Drive, Suite 200
Lexington, Kentucky 40513
(859) 219-4000

APR 27 2016

RECEIVED

By Darla Bowen at 6:40 am, Apr 28, 2016

Mr. Brian Begley
Federal Facility Agreement Manager
Division of Waste Management
Kentucky Department for Environmental Protection
200 Fair Oaks Lane, 2nd Floor
Frankfort, Kentucky 40601

PPPO-02-3449802-16

Ms. Julie Corkran
Federal Facility Agreement Manager
U.S. Environmental Protection Agency, Region 4
61 Forsyth Street
Atlanta, Georgia 30303

Dear Mr. Begley and Ms. Corkran:

TRANSMITTAL OF THE NORTHEAST PLUME INTERIM REMEDIAL ACTION OPTIMIZATION REMEDIAL ACTION WORK PLAN, DOE/LX/07-1280&D2/R3

References:

1. Letter from J. Corkran to T. Duncan, "U.S. EPA Region 4 Conditions on: Appendix D—Northeast Plume Optimization Quality Assurance Project Plan for the Remedial Action Work Plan for Optimization of the Northeast Plume Interim Remedial Action at the Paducah Gaseous Diffusion Plant, Paducah, KY (DOE/LX/07-1280&D2/R2/A1), February 2016, EPA ID KY8890008982, McCracken County, KY," dated March 28, 2016
2. Letter from A. Webb to T. Duncan, "Submittal of Comments to the Addendum to the Remedial Action Work Plan for Optimization of the Northeast Plume Interim Remedial Action—Appendix D Quality Assurance Project Plan (1280&D2/R2/A1), Paducah Site, Paducah, McCracken County, Kentucky, KY8-890-008-982," dated March 9, 2016
3. Letter from J. Corkran to T. Duncan, "EPA Region 4 Conditions for Approval: Remedial Action Work Plan for Optimization of the Northeast Plume Interim Remedial Action at the Paducah Gaseous Diffusion Plant, Paducah, Kentucky, DOE/LX/07-1280&D2/R2, EPA ID KY8890008982, McCracken County, KY," dated March 4, 2016
4. Letter from T. Duncan to B. Begley and J. Corkran, "Remedial Action Work Plan for the Optimization of the Northeast Plume Interim Remedial Action at the Paducah Gaseous Diffusion Plant, Paducah, Kentucky, DOE/LX/07-1280&D2/R2," (PPPO-02-2325371-16), dated February 12, 2016

Please find the enclosed the certified *Remedial Action Work Plan for the Optimization of the Northeast Plume Interim Remedial Action at the Paducah Gaseous Diffusion Plant, Paducah, Kentucky*, DOE/LX/07-1280&D2/R3 (RAWP) for your approval.

The enclosed document incorporates the responses to the condition for approval on the *Remedial Action Work Plan for the Optimization of the Northeast Plume Interim Remedial Action at the Paducah Gaseous Diffusion Plant, Paducah, Kentucky*, DOE/LX/07-1280&D2/R2, received from the U.S. Environmental Protection Agency (EPA) received on March 4, 2016. The enclosed document also incorporates the changes made to address the comments on the *Addendum to the Remedial Action Work Plan for Optimization of the Northeast Plume Interim Remedial Action at the Paducah Gaseous Diffusion Plant, Paducah, Kentucky*, DOE/LX/07-1280&D2/R3/A2—Appendix D, Quality Assurance Project Plan (QAPP) received from EPA and the Kentucky Department for Environmental Protection on March 28, 2016, and March 9, 2016, respectively. Moreover, a comment resolution meeting among the Federal Facility Agreement (FFA) parties was held April 18, 2016, and the results of that meeting have been incorporated. The FFA parties agreed to merge the RAWP and QAPP into a single document. As a result, minor unsolicited changes were required. A summary of the unsolicited changes is included to document these changes to the document. To assist with your review, a redline version of the RAWP (including Appendix D—QAPP), RAWP condition response summary, and QAPP comment response summaries are enclosed that provide documentation of resolution of the condition and comments. To minimize impacts to the Northeast Plume Optimization project fieldwork start date, DOE respectfully requests approval of the RAWP on or before May 27, 2016.

In addition, a CD including project-specific standard operating procedures is being included for reference.

If any questions or require additional information, please contact David Dollins at (270) 441-6819.

Sincerely,



Tracey Duncan
Federal Facility Agreement Manager
Portsmouth/Paducah Project Office

Enclosures:

1. Certification Page
2. Combined Northeast Plume RAWP and Appendix D-QAPP, DOE/LX/07-1280&D2/R3 (clean)
3. Combined Northeast Plume RAWP and Appendix D-QAPP, DOE/LX/07-1280&D2/R3 (redline)
4. RAWP Condition Response Summary—EPA
5. Other Changes Summary

6. Appendix D - QAPP Comment Response Summary—EPA
7. Appendix D - QAPP Comment Response Summary—Kentucky
8. Reference CD – Project-Specific Standard Operating Procedures

e-copy w/enclosures:

april.webb@ky.gov, KDEP/Frankfort
brian.begley@ky.gov, KDEP/Frankfort
corkran.julie@epa.gov, EPA/Atlanta
craig.jones@ffspaducah.com, FFS/Kevil
dave.dollins@lex.doe.gov, PPPO/PAD
ffscorrespondence@ffspaducah.com, FFS/Kevil
gaye.brewer@ky.gov, KDEP/PAD
jennifer.woodard@lex.doe.gov, PPPO/PAD
leo.williamson@ky.gov, KDEP/Frankfort
mark.duff@ffspaducah.com, FFS/Kevil
mike.guffey@ky.gov, KDEP/Frankfort
myrna.redfield@ffspaducah.com, FFS/Kevil
nathan.garner@ky.gov, KYRHB/Frankfort
pad.rmc@swiftstaley.com, SSI/Kevil
reinhard.knerr@lex.doe.gov, PPPO/PAD
richards.jon@epamail.epa.gov, EPA/Atlanta
stephaniec.brock@ky.gov, KYRHB/Frankfort
todd.powers@ffspaducah.com, FFS/Kevil
tracey.duncan@lex.doe.gov, PPPO/PAD

CERTIFICATION

Document Identification: *Remedial Action Work Plan for Optimization of the Northeast Plume Interim Remedial Action at the Paducah Gaseous Diffusion Plant, Paducah, Kentucky, DOE/LX/07-1280&D2/R3*

I certify under penalty of law that this document and all attachments were prepared under my direction or supervision in accordance with a system designed to ensure that qualified personnel properly gather and evaluate the information submitted. Based on my inquiry of the person or persons directly responsible for gathering the information, the information submitted is, to the best of my knowledge and belief, true, accurate, and complete. I am aware that there are significant penalties for submitting false information, including the possibility of fine and imprisonment for knowing violations.

Fluor Federal Services, Inc.



Mark J. Duff, Environmental Management Director

4-27-16

Date Signed

I certify under penalty of law that this document and all attachments were prepared under my direction or supervision in accordance with a system designed to ensure that qualified personnel properly gather and evaluate the information submitted. Based on my inquiry of the person or persons directly responsible for gathering the information, the information submitted is, to the best of my knowledge and belief, true, accurate, and complete. I am aware that there are significant penalties for submitting false information, including the possibility of fine and imprisonment for knowing violations.

U.S. Department of Energy (DOE)

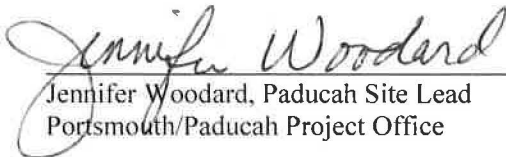

Jennifer Woodard, Paducah Site Lead
Portsmouth/Paducah Project Office

4/27/16

Date Signed

**Remedial Action Work Plan for Optimization
of the Northeast Plume
Interim Remedial Action at the
Paducah Gaseous Diffusion Plant,
Paducah, Kentucky**



CLEARED FOR PUBLIC RELEASE

**Remedial Action Work Plan for Optimization
of the Northeast Plume
Interim Remedial Action at the
Paducah Gaseous Diffusion Plant,
Paducah, Kentucky**

Date Issued—April 2016

U.S. DEPARTMENT OF ENERGY
Office of Environmental Management

Prepared by
FLUOR FEDERAL SERVICES, INC.,
Paducah Deactivation Project
managing the
Deactivation Project at the
Paducah Gaseous Diffusion Plant
under Task Order DE-DT0007774

CLEARED FOR PUBLIC RELEASE

THIS PAGE INTENTIONALLY LEFT BLANK

PREFACE

This *Remedial Action Work Plan for Optimization of the Northeast Plume Interim Remedial Action at the Paducah Gaseous Diffusion Plant, Paducah, Kentucky*, DOE/LX/07-1280&D2/R3, was prepared in accordance with requirements under the Comprehensive Environmental Response, Compensation, and Liability Act of 1980. The objectives of this plan are to (1) describe the purpose and scope of the changes to the interim remedial action and the planned optimizations, (2) identify the project organization, (3) present the project working schedule, and (4) identify other key project documents and plans.

THIS PAGE INTENTIONALLY LEFT BLANK

CONTENTS

PREFACE.....	iii
FIGURES.....	vii
TABLES	vii
ACRONYMS.....	ix
EXECUTIVE SUMMARY	xi
1. INTRODUCTION.....	1
1.1 PURPOSE OF THE INTERIM REMEDIAL ACTION OPTIMIZATION	1
1.2 MEMORANDUM OF AGREEMENT FOR RESOLUTION.....	2
1.3 SCOPE OF THE INTERIM REMEDIAL ACTION OPTIMIZATION	4
2. REMEDIAL ACTION APPROACH.....	6
2.1 WELLFIELD OPTIMIZATION MODELING.....	6
2.2 WELLFIELD AND SYSTEM DESIGN.....	10
2.2.1 Key Design Changes	10
2.2.2 Key Design Assumptions	10
2.2.3 North-South Monitoring Well Transect.....	12
2.2.4 Wellfield Design.....	15
2.2.5 Baseline Monitoring	16
2.3 START-UP AND INTEGRATED TESTING.....	16
2.4 OPERATIONS AND MAINTENANCE	17
2.5 MONITORING	18
2.6 WASTE MANAGEMENT AND DISPOSITION	23
3. PROJECT ORGANIZATION.....	23
4. PROJECT SCHEDULE	24
5. HEALTH AND SAFETY PLAN.....	24
6. ENVIRONMENTAL COMPLIANCE PLAN	26
6.1 WITHDRAWAL OF PUBLIC WATERS.....	26
6.2 AIR EMISSIONS	26
6.3 POST-RECORD OF DECISION DOCUMENTATION	29
6.3.1 Explanation of Significant Differences	29
6.3.2 Memorandum of Agreement for Resolution of Formal Dispute (July 2015)	29
6.3.3 Interim Remedial Action Metrics and Performance Monitoring.....	29
6.3.4 Semiannual Progress Reports	33
7. WASTE MANAGEMENT	33
7.1 WASTE GENERATION AND PLANNING.....	34
7.1.1 Waste Generation	34
7.1.2 Soil from Drilling and Construction Activities	34
7.1.3 Personal Protective Equipment.....	35
7.1.4 Grout.....	35
7.1.5 Well Installation/Development/Decontamination/Sample Residual Water.....	36

7.1.6	Miscellaneous Noncontaminated/Clean Trash	36
7.2	WASTE CHARACTERIZATION	36
7.3	CONTAINERS, ABSORBENT, AND DRUM LINERS	37
7.4	WASTE MANAGEMENT ROLES AND RESPONSIBILITIES	37
7.4.1	Waste Management Tracking Responsibilities	37
7.4.2	Waste Management Coordinator	37
7.4.3	Coordination with Field Crews	38
7.4.4	Coordination with Treatment, Storage, and Disposal Facilities	38
7.4.5	Waste Management Training	38
7.5	TRANSPORTATION OF WASTE	38
7.6	SAMPLE SCREENING	39
7.6.1	Screening of Analytical Samples	39
7.6.2	Field Screening	39
7.6.3	On-Site Laboratory Radiation Screening	39
7.7	WASTE MINIMIZATION	39
7.8	HEALTH AND SAFETY ISSUES RELATED TO WASTE ACTIVITIES	39
7.9	WASTE SAMPLING AND ANALYSIS PLAN	40
7.9.1	Contained-In/Contaminated-With Determinations	40
7.9.2	Waste Characterization	42
7.10	SAMPLING AND ANALYSIS OF WASTE	45
7.10.1	Solid Waste	45
7.10.2	Aqueous Liquids	45
8.	QUALITY ASSURANCE AND CONSTRUCTION QUALITY CONTROL PLAN	46
8.1	INTRODUCTION	46
8.2	SITE DESCRIPTION	46
8.3	PROJECT ORGANIZATION	46
8.4	QUALITY ASSURANCE METHODS	47
8.4.1	Implementation	47
8.4.2	Documenting	47
8.5	INSPECTIONS	47
8.6	FIELD TESTING PROCEDURES	48
8.7	SUBMITTALS	48
8.8	DOCUMENTATION	49
8.9	REVISIONS TO WORK	49
8.10	DEFINABLE FEATURES OF WORK	49
9.	DATA MANAGEMENT AND IMPLEMENTATION PLAN	50
10.	REFERENCES	50
APPENDIX A:	CONSTRUCTION FIGURES	A-1
APPENDIX B:	AIR DISPERSION ANALYSIS	B-1
APPENDIX C:	NORTHEAST PLUME EXTRACTION SYSTEM DESIGN AND EVALUATION	C-1
APPENDIX D:	NORTHEAST PLUME OPTIMIZATION QUALITY ASSURANCE PROJECT PLAN	D-1

FIGURES

1.	Northeast Plume Extraction Wells	7
2.	Optimized Extraction Wells Relationship to Tc-99 and TCE Contamination	13
3.	Transect Monitoring Well Locations East of C-400	14
4.	Northeast Plume Hydraulic Monitoring Network	21
5.	Northeast Plume Chemical Monitoring Network.....	22
6.	Northeast Plume ATU Effluent Drainage to Little Bayou Creek	27
7.	Northeast Plume Optimization Effluent Pathway to Little Bayou Creek.....	28

TABLES

1.	General Activities Governed by Procedures	8
2.	Approximate Location of Transect Monitoring Wells	15
3.	Summary of Sampling, Analysis, and Data Collection	18
4.	Northeast Plume Optimization Monitoring Network.....	19
5.	Project Planning Schedule.....	25
6.	Estimation of Waste	35
7.	Health-Based Levels for TCE and 1,1,1-TCA	41
8.	TCLP Parameters for Analysis of Solid Waste	42
9.	Analytical Parameters for Radiological and PCB Characterization.....	43
10.	Waste Characterization Requirements for Solid Waste	43
11.	Waste Characterization Requirements for Decontamination, Development, and Purge Water	43

THIS PAGE INTENTIONALLY LEFT BLANK

ACRONYMS

ARAR	applicable or relevant and appropriate requirement
CERCLA	Comprehensive Environmental Response, Compensation, and Liability Act
<i>CFR</i>	<i>Code of Federal Regulations</i>
CQCP	construction quality control plan
DMIP	data management implementation plan
DOE	U.S. Department of Energy
DOECAP	DOE Consolidated Audit Program
EPA	U.S. Environmental Protection Agency
ER	environmental restoration
ESD	explanation of significant differences
EW	extraction well
FFA	Federal Facility Agreement
H&S	health and safety
IRA	interim remedial action
<i>KAR</i>	<i>Kentucky Administrative Regulations</i>
KEEC	Kentucky Energy and Environment Cabinet
KPDES	Kentucky Pollutant Discharge Elimination System
<i>KRS</i>	<i>Kentucky Revised Statutes</i>
LDR	land disposal restriction
LLW	low-level waste
MOA	Memorandum of Agreement
NE Plume	Northeast Plume
NEPCS	Northeast Plume Containment System
O&M	operation and maintenance
PGDP	Paducah Gaseous Diffusion Plant
PPE	personal protective equipment
PZ	piezometer
QA	quality assurance
QAPP	Quality Assurance Project Plan
QC	quality control
RAWP	remedial action work plan
RCRA	Resource Conservation and Recovery Act
RFD	Request for Disposal
RGA	Regional Gravel Aquifer
ROD	record of decision
RWP	radiological work permit
TCLP	Toxicity Characteristic Leaching Procedure
TRU	transuranic waste
TSCA	Toxic Substance Control Act
TSDF	treatment, storage, and disposal facility
TU	treatment unit
TVA	Tennessee Valley Authority
USEC	United States Enrichment Corporation
VOC	volatile organic compound
VOHAP	volatile organic hazardous air pollutants
WAC	waste acceptance criteria
WKWMA	West Kentucky Wildlife Management Area
WMC	waste management coordinator

WMP waste management plan

EXECUTIVE SUMMARY

The Paducah Gaseous Diffusion Plant (PGDP) is an inactive uranium enrichment facility owned by the U.S. Department of Energy (DOE) and formerly operated by the United States Enrichment Corporation (USEC) until 2014. DOE is conducting environmental restoration (ER) activities at PGDP in compliance with the requirements of the Commonwealth of Kentucky and the U.S. Environmental Protection Agency (EPA) under the Comprehensive Environmental Response, Compensation, and Liability Act (CERCLA). PGDP was placed on the National Priorities List in 1994 and DOE, EPA, and the Commonwealth of Kentucky entered into a Federal Facility Agreement in 1998 (EPA 1998).

The Northeast Plume Interim Remedial Action (IRA) is a CERCLA action documented in a record of decision located in the Administrative Record at <http://www.paducaheic.com/media/41288/i-00213-0004-ARI34.pdf>. The post-decision Administrative Record is located at the Environmental Information Center or may be reviewed electronically by pressing control and clicking: <http://www.paducaheic.com/search.aspx?i=PDI09&> and selecting (PD) (GW3-PD) Post-decision NE Plume in the index dropdown box. Since initiation, the scope of the Northeast Plume IRA has been the following:

1. Extract groundwater from the Northeast Plume using two extraction wells (EWs) located approximately 3,000 ft (914 m) east of the PGDP industrial facility near Ogden Landing Road (Kentucky Highway 358) (see Figure 1);
2. Convey the contaminated groundwater to water cooling towers at the PGDP industrial facility operated by USEC through August 2013 and via a treatment unit (TU) since August 2013 to remove trichloroethene (TCE) contaminant by air stripping; and
3. Convey the treated water via pipeline to an outfall that releases the water to the Bayou Creek. A Kentucky Pollutant Discharge Elimination System outfall was used with the PGDP water cooling towers. Since August 2013, and start-up of the alternative TU, a CERCLA outfall is being used.

This Northeast Plume IRA optimization project is intended to increase volatile organic compound mass removal and enhance capture of contaminants migrating in the Northeast Groundwater Plume at the eastern edge of the PGDP industrial facility (see Figure 1). This optimization action was initiated in response to deactivation of PGDP and the recommendations documented in the following:

- 2003 CERCLA Five-Year Review (DOE 2003) and approval letters (EPA 2003; KDEP 2003);
- Sitewide Remedy Review (DOE 2006);
- *Review Report: Groundwater Remedial System Performance Optimization at PGDP, Paducah, Kentucky* (DOE 2007);
- 2008 CERCLA Five-Year Review (DOE 2009) and approval letters (EPA 2009; KEEC 2009);
- 2013 CERCLA Five-Year Review (DOE 2014);
- Site Management Plan (DOE 2012); and

- Negotiations among the Federal Facility Agreement (FFA) parties, which resulted in the *Memorandum of Agreement for Resolution of Formal Dispute of the Explanation of Significant Differences to the Record of Decision for the Interim Remedial Action of the Northeast Plume at the Paducah Gaseous Diffusion Plant, Paducah, Kentucky (DOE/LX/07-1291&D2)*, and *Remedial Action Work Plan for Optimization of the Northeast Plume Interim Remedial Action at the Paducah Gaseous Diffusion Plant, Paducah, Kentucky (DOE/LX/07-1280&D2)* (DOE 2015a) (MOA for Resolution).

The wellfield optimization effort was undertaken using the updated PGDP groundwater flow model documented in *2008 Update of the Paducah Gaseous Diffusion Plant Sitewide Groundwater Flow Model* (DOE 2008a). The updated PGDP groundwater flow model was coupled with Brute Force, a particle tracking optimization code based on sequential MODFLOW-2000 (Harbaugh et al. 2000) and MODPATH (Pollack 1994) modeling software. Simulation runs for multiple well scenarios were executed for typical, minimal, and maximum recharge conditions (with and without anthropogenic recharge) to determine the dissolved mass capture efficiency of contaminants migrating in both the Northeast and Northwest Plumes. Groundwater modeling predicts that mass capture will be in excess of 90% using existing Northwest Plume EW, EW232, pumping at 220 gpm; an EW located in the vicinity of C-400 pumping at 80 gpm; two Northeast Plume optimized EWs located in the high-concentration portion of the Northeast Plume along the eastern edge of the PGDP industrial facility; and when the wells have a combined extraction rate of 300 gpm (150 gpm each). (Note: No EW at C-400 is planned as part of this optimization project.) The target pumping rate for each new EW will be 150 gpm, for a total production of 300 gpm for the optimized IRA.

As a result of the cessation of uranium enrichment operations at PGDP, the use of the C-637 Cooling Towers as an air stripper facility for TCE-contaminated groundwater was discontinued. One objective of the optimization process is to provide an alternate means of treating the contaminated groundwater from the original EWs (EW331 and EW332) until the new optimized EWs are installed. To support continued operation of the IRA until the optimization project is complete, one of the TUs, which was planned to be installed as part of extraction system optimization, was installed in 2013 and is located near the planned location for EW234. This TU was plumbed temporarily to the pipeline that conveys groundwater from the existing EWs (EW331 and EW332, located approximately 3,000 ft northeast of the plant site near Ogden Landing Road) and is being used temporarily to continue treatment of groundwater from the two existing Northeast Plume EWs (EW331 and EW332). This arrangement will continue until the optimization project is completed and the use of the new EWs is initiated. The MOA for Resolution states the following:

If FFA parties decide to implement a modification to the Interim Remedial Action to address the NE Plume contamination (including the expansion), then depending on the scope of the modifications it is possible that the FFA parties will decide to shut-down the optimized pump and treat system in part or in its entirety. If a determination is made to shut down the optimized pump and treat system either before a modification to the Interim Remedial Action or as part of a modification to the Interim Action, then DOE shall reinstate implementation of the NE Plume Interim Remedial Action (Interim ROD 1995). DOE shall keep the extraction wells associated with the NE Plume Interim Remedial Action in good working condition until the FFA parties agree the maintenance is no longer necessary (DOE 2015a).

The optimization project includes installation of two new EWs—EW234 and EW235—in optimized locations and two associated TUs, including the TU that was installed in 2013 near the planned location of EW234. As part of the optimization project, this TU will be replumbed to allow it to treat groundwater from EW234. The TU then will become part of the optimized system servicing EW234. One additional

TU will be installed and plumbed to allow treatment of groundwater extracted from the planned optimization extraction well, EW235.

The two TU systems will include, but not be limited to, a skid-mounted treatment system consisting of a high efficiency air stripper, air blower, effluent pump, influent bag filters, and process control system. The equipment will be enclosed in a heated weatherproof enclosure. In addition, the EW234 TU will include a tie-in point to the existing Northeast Plume IRA EWs. Separate TUs will be used to treat extracted water from each new optimized EW (EW234 and EW235) and will be located in the same general area as the new optimized EWs. Following removal of the TCE contamination by each TU associated with EW234 and EW235, the water will be released through CERCLA outfalls to tributaries of Little Bayou Creek.

The optimized Northeast Plume IRA will include installation of 14 monitoring wells with single screens and 8 piezometers to evaluate performance and effectiveness of the optimized EWs. Seven of these monitoring wells will be located in a north-south transect located approximately 600 ft east of the C-400 Building. Samples from these transect monitoring wells will be used to establish baseline TCE and technetium-99 concentrations before the EWs begin operation and to assess the impact of groundwater EWs on contamination migration from source areas, including impacts to the groundwater divide east of C-400 Building.

THIS PAGE INTENTIONALLY LEFT BLANK

1. INTRODUCTION

In August 1988, volatile organic compounds (VOCs) and radionuclides were detected in private water wells north of the Paducah Gaseous Diffusion Plant (PGDP). The principal contaminants of concern discovered in off-site groundwater in this area were trichloroethene (TCE) and technetium-99 (Tc-99). Contaminated groundwater emanating from the eastern portion of PGDP industrial facility is referred to as the Northeast Plume, and an interim remedial action (IRA) was identified in the early 1990s in response to contaminants associated with the Northeast Plume. The *Record of Decision for Interim Remedial Action at the Northeast Plume, Paducah Gaseous Diffusion Plant, Paducah, Kentucky* (ROD) (DOE 1995), was signed in June 1995 (DOE 1995). As stated in the Declaration for the ROD, “the primary objective of this interim remedial action is to implement a first-phase remedial action as an interim action to initiate hydraulic control of the high concentration within the Northeast Plume that extends outside the plant security fence.” Also, stated in the ROD in the Summary of Site Risks Section is, “The principal goal of this interim remedial action is to implement control measures which will mitigate migration of the contaminants.”

The Northeast Plume Containment System (NEPCS) construction was completed in 1997. Specifically, integrated system testing and start-up operations were conducted in February 1997. Normal operations began on February 28, 1997, and the system has been running in normal operation and maintenance (O&M) phase since that time.

Two extraction wells (EWs) currently comprise the NEPCS. Each of these EWs is equipped with a submersible pump, riser pipe, and electrical service. After extraction, the groundwater is pumped through a transfer line to an underground equalization tank. A transfer pump moves the groundwater from the EW tank through approximately 5,500 linear ft of transfer piping to the PGDP C-637 cooling tower system. The contaminated water was discharged into the top of either cooling tower C-637-2A or C-637-2B. After treatment, the water flowed through the gaseous diffusion plant recirculated cooling water system before ultimately being discharged to the U.S. Department of Energy (DOE) permitted Kentucky Pollutant Discharge Elimination (KPDES) Outfall 001. Since cessation of PGDP enrichment operations in 2013, the contaminated water has entered a treatment unit (TU) and undergone air stripping before being released to a Comprehensive Environmental Response, Compensation, and Liability Act (CERCLA) outfall, located downstream of DOE’s permitted KPDES Outfall 002.

This remedial action work plan (RAWP) is intended to provide background information, identify scope optimization elements, define the project organization, identify project plans and procedures, and present a project planning schedule for optimization of the Northeast Plume IRA.

1.1 PURPOSE OF THE INTERIM REMEDIAL ACTION OPTIMIZATION

The Northeast Plume IRA optimization project is to serve as an interim measure to increase TCE mass removal, to enhance control of the Northeast Plume migration at the eastern edge of the PGDP industrial facility, and to reduce further migration off-site. This action was initiated in response to recommendations documented in the following documents:

- 2003 CERCLA Five-Year Review (DOE 2003) and approval letters (EPA 2003; KDEP 2003)
- Sitewide Remedy Review (DOE 2006)

- Review Report: Groundwater Remedial System Performance Optimization at PGDP, Paducah, Kentucky (DOE 2007)
- 2008 CERCLA Five-Year Review (DOE 2009) and approval letters (EPA 2009; KEEC 2009)
- Site Management Plan (DOE 2012)
- 2013 CERCLA Five-Year Review (DOE 2014)
- *Memorandum of Agreement for Resolution of Formal Dispute of the Explanation of Significant Differences to the Record of Decision for the Interim Remedial Action of the Northeast Plume at the Paducah Gaseous Diffusion Plant, Paducah, Kentucky (DOE/LX/07-1291&D2), and Remedial Action Work Plan for Optimization of the Northeast Plume Interim Remedial Action at the Paducah Gaseous Diffusion Plant, Paducah, Kentucky (DOE/LX/07-1280&D2) (DOE 2015a) (MOA for Resolution), signed by the Federal Facility Agreement (FFA) parties on July 31, 2015*

The planned implementation of the optimized IRA was evaluated along with other Groundwater Operable Unit projects relative to site priorities. The prioritization was performed by the FFA managers, with consideration given to the sitewide strategy that includes a series of sequenced activities consisting of source actions and control of off-site groundwater migration followed by a final action for the overall dissolved-phased plume. This evaluation resulted in the optimization of the Northeast Plume IRA being prioritized above the dissolved-phase plume decision documents. The results of this prioritization were documented in an April 2011 Modification to the Paducah Federal Facility Agreement (Knerr 2011).

The Site Management Plan for fiscal year 2012 identified an evaluation of the Northeast Plume extraction system similar to the Northwest Plume IRA system optimization in the DOE planning assumptions for the Life Cycle Baseline.

1.2 MEMORANDUM OF AGREEMENT FOR RESOLUTION

The MOA for Resolution states the following:

The resolution documents the Parties' agreement that an optimization of the existing Northeast (NE) Plume Interim Action (namely relocation of the two extraction wells up-gradient and operation of two treatment units) is warranted to increase trichloroethylene (TCE) mass removal and to enhance control of NE Plume migration at the eastern edge of the PGDP industrial facility. The Parties have reached consensus that the optimized extraction wells installed under the NE Plume Explanation of Significant Differences (ESD) should not cause or contribute to the undesired migration of Technetium-99 (Tc-99) contamination from the source area(s) (e.g., C-400 Building and Northwest (NW) Plume) and that actions (as further described below) may be undertaken to prevent any undesirable expansion of Tc-99 and TCE within the NE Plume.

1. The NE Plume ESD and Remedial Action Work Plan (RAWP) will be revised to include language similar to that found in the 1995 IROD and Draft Final (D2) RAWP for the NE Plume stating that pumping at the optimized extraction wells may result in changes to groundwater flow direction that may impact contaminant (i.e. TCE and/or Tc-99) migration from source areas (e.g. C-400 Building). The NE Plume ESD and RAWP will state that the modified NE Plume interim remedial action will include installation (at a minimum) of five new RGA monitoring wells in a north-south transect

approximately 600 feet east of C-400 Building (exact locations to be determined by the FFA parties as part of the finalization of the RAWP). These transect monitoring wells will be used to assess the impact of groundwater extraction wells on contaminant migration from source areas, including impacts to the groundwater divide east of C-400 Building.

2. The transect monitoring wells will be monitored for 4 consecutive quarters to establish baseline contaminant concentrations before the two newly relocated extraction wells begin operation. The anticipated contaminant concentrations of Tc-99 and TCE in the transect monitoring wells are expected to be no higher than 200 pCi/L and 600 ug/L, respectively. If baseline contaminant concentrations in any of the transect monitoring wells during the initial quarterly sampling are detected at twice the anticipated contaminant concentrations, then the FFA parties agree to temporarily suspend start-up of the extraction wells until the parties meet to evaluate the identified discrepancy, its potential impact on the NW Plume source actions and the planned NE Plume optimization project. The FFA parties will conduct an evaluation of the planned action and develop recommendations and a schedule for modifications of the optimized action to address the unanticipated contaminant concentrations. In the event the FFA parties decide that significant changes to the scope of the action under the ESD are necessary to continue with the optimization, then DOE shall continue implementing the current NE Plume Interim Remedial Action (Interim ROD 1995) and shall propose modification to the Interim Remedial Action through another ESD and RAWP Addendum. The PGDP Site Management Plan will be updated to reflect establishment of any enforceable milestones under the FFA such as due dates for the aforementioned Primary documents.

3. Once the two optimized extraction wells are online, contaminant concentrations in samples from the transect wells will be collected on a quarterly basis and reported to EPA and KDEP. If contaminant concentrations in any transect well's quarterly samples are determined to be increasing and may double above the established baseline within a year of the quarterly samples showing an increase, then potential changes in groundwater flow or source impacts (e.g. rising contaminant concentrations in the NE Plume, source migration, etc.) will be further examined and the FFA parties will consider adjustments (e.g. adjusting extraction well pumping rates) for the optimized NE Plume interim action to minimize these potential impacts. These adjustments are considered within the scope of the optimization under the ESD.

4. If the measures taken by the FFA parties (e.g. adjusting extraction well pumping rates) do not result in decreased or stabilized concentrations at the transect monitoring wells, or if such adjustments reduce the effectiveness of the optimized extraction wells or if Tc-99 concentrations continue to increase and are detected at twice their baseline concentration in any one (or more) of the transect wells for two consecutive quarters, then DOE must notify EPA and KDEP within 30 days of receiving sampling results or one of the other aforementioned conditions occurring. After EPA and KDEP have been notified, the FFA parties will discuss and evaluate options to address continued increase of groundwater concentrations and plume expansion. Within 1 year from the notification, DOE shall submit an ESD and RAWP Addendum as the Primary documents to undertake modification to the existing CERCLA Interim Remedial Action pursuant to the FFA to address the contaminated groundwater plume expansion and to prevent Tc-99 at levels above the MCL from further being pulled within the NE Plume.

The FFA parties will discuss whether to temporarily suspend operation of one or both of the extraction wells while determining the modifications to the CERCLA Interim Remedial Action to prevent further plume expansion. If FFA parties decide to implement a modification to the Interim Remedial Action to address the NE Plume contamination (including the expansion), then depending on the scope of the modifications it is possible that the FFA parties will decide to shut-down the optimized pump and treat system in part or in its entirety. If a determination is made to shut down the optimized pump and treat system either before a modification to the Interim Remedial Action or as part of a modification to the Interim Action, then DOE shall reinstate implementation of the NE Plume Interim Remedial Action (Interim ROD 1995). DOE shall keep the extraction wells associated with the NE Plume Interim Remedial Action in good working condition until the FFA parties agree the maintenance is no longer necessary.

5. The Nuclear Regulatory Commission regulation [10 CFR Part 20, Appendix B, 902 KAR 100:019 Section 44(7)(a)] specifying a facility-wide annual effluent limit of 60,000 pCi/L for discharges of Tc-99 into surface water that was included in the D2 NE Plume ESD ARARs table will not be included as an ARAR in the D2 (Rev.1) NE Plume ESD.

6. This dispute resolution agreement by the SEC (including the terms and conditions described above) resolves the formal dispute invoked by DOE and the EPA and Kentucky Conditions for approval of the NE Plume ESD and RAWP (Reference November 12, 2013, letter and November 13, 2013, letter respectively) are superseded by this dispute resolution agreement's terms and conditions. A D2 (Rev.1) NE Plume ESD and RAWP incorporating the terms and conditions of this SEC dispute resolution agreement will be submitted to EPA and KY for review/approval within 30 days of the date of the last FFA party signature on this agreement (DOE 2015a).

1.3 SCOPE OF THE INTERIM REMEDIAL ACTION OPTIMIZATION

Cessation of enrichment operations at PGDP by the United States Enrichment Corporation (USEC) in June 2013 resulted in the loss of the cooling tower that acted as the air stripper and provided further need to optimize the system with the use of a TU that could air strip the contamination.

Once the cooling towers no longer were available, it became necessary to provide an alternate means of treating the contaminated groundwater until the IRA is optimized completely with two new EWs and associated TUs (two modular units are planned to address the capacity needs of the new wells). To support the continued operation of the IRA until the optimization project is complete, one of the TUs was installed in 2013 and located near the planned location for EW234. This TU was plumbed temporarily to the pipeline that conveys groundwater from the existing EWs (EW331 and EW332, located approximately 3,000 ft northeast of the plant site near Ogden Landing Road) and is being used temporarily to continue treatment of groundwater from the two existing Northeast Plume EWs (EW331 and EW332). This arrangement will continue until the optimization project is completed and the use of the existing EWs is discontinued. As required by Section 4 of the MOA for Resolution, DOE must keep the EWs associated with the Northeast Plume IRA in good working condition until the FFA parties agree the maintenance no longer is necessary.

The optimization project will include installation of two new EWs—EW234 and EW235—in optimized locations and two associated TUs. As part of the optimization project, the TU, located near planned EW234, will be plumbed to allow it to treat groundwater from EW234. The TU then will become part of

the optimized system servicing EW234. One additional TU will be installed and plumbed to allow treatment of groundwater extracted from the planned optimization extraction well, EW235.

The two TU systems each will include a skid-mounted treatment system consisting of a high efficiency air stripper, air blower, effluent pump, influent bag filters, and process control system. The equipment will be enclosed in a heated weatherproof enclosure. In addition, the EW234 TU will include a tie-in point to the original Northeast Plume IRA EWs. Separate TUs will be used to treat extracted water from each new optimized EW (EW234 and EW235) and will be located in the same general area as the new optimized EWs. Following removal of the TCE contamination by each treatment unit associated with EW234 and EW235, the water will be released through CERCLA outfalls to tributaries of Little Bayou Creek.

The Northeast Plume IRA System optimization will include the following:

- (1) Design and installation of two new EWs along with necessary subsurface equipment;
- (2) Design and installation of 14 monitoring wells and 8 piezometers to evaluate performance and effectiveness of the optimized EWs. Included in this system of 14 monitoring wells with single screens will be 7 new Regional Gravel Aquifer (RGA) monitoring wells in a north-south transect located approximately 600 ft east of the C-400 Building. Sampling results from the transect monitoring wells will be used to establish baseline TCE and Tc-99 concentrations in the area of their installation and assess impacts of the EWs on contaminant migration from source areas, including impacts to the groundwater divide east of C-400 Building. The MOA requires quarterly sampling of the transect monitoring wells prior to and after installation of the EWs. The MOA for Resolution requires four consecutive quarters of baseline sampling of the north-south transect monitoring wells during the first year and requires specific actions based on the sampling analytical results;
- (3) Design and installation of new pipelines with monitoring and process control systems for conveying the extracted RGA water to the new alternative treatment systems;
- (4) Design and installation of process controllers, and electrical service for transferring the water to the treatment systems;
- (5) Design and installation of new treatment equipment and/or associated equipment for EW234 and EW235;
- (6) Interface with other stake holders including West Kentucky Wildlife Management Area (WKWMA), EPA, Commonwealth of Kentucky (KY), and the public, as necessary;
- (7) Placement of existing EWs, pipelines, and facilities into a stand-by condition; original wells EW331 and EW332 will be kept in good working condition until the FFA parties agree the maintenance no longer is necessary; and
- (8) Performance of integrated system testing and startup of systems and facilities. Training of operations staff is included as a part of this project. Changes to the system operation will be documented in a revision to the O&M plan.

Operation of the optimized IRA system will be initiated upon completion of construction and start-up testing and contingent upon the results of baseline and ongoing monitoring activities described in Sections 2 and 4 of the MOA for Resolution (DOE 2015a). The optimization of the Northeast Plume IRA

is intended to increase TCE and 1,1-dichloroethene (DCE) mass removal and enhance control of Northeast Plume migration at the eastern edge of the PGDP industrial facility and to reduce further migration off-site (see Figure 1). The optimization of the IRA is expected to assist PGDP in attaining positive environmental indicators.

2. REMEDIAL ACTION APPROACH

The DOE deactivation contractor has overall contractor responsibility for the planning, design, procurement, construction, and testing and then the follow-on O&M, waste management, and waste disposal associated with the remedy. The major activities for this remedial action are outlined in this section.

Table 1 is a general list of activities governed by procedures. Procedures referenced in the table are those followed by the current DOE prime contractor. The most current versions of all contractor procedures are to be used. This RAWP, plans referenced by this RAWP, and applicable procedures will be readily available in the field to project personnel, including subcontractors, either in hard copy or electronic format. If electronic files are provided, a computer will be available for assessing the documents.

2.1 WELLFIELD OPTIMIZATION MODELING

The wellfield optimization effort was undertaken using the 2008 updated PGDP groundwater flow model (DOE 2008a). The 2008 updated PGDP groundwater flow model was developed through group consensus and accepted for use by the Groundwater Modeling Discussion Group. The Groundwater Modeling Discussion Group included representation of the FFA parties and supporting subcontractors. The 2008 updated groundwater flow model is coupled with Brute Force, a particle tracking optimization code based on sequential MODFLOW2000 (Harbaugh et al. 2000) and MODPATH (Pollack 1994) modeling software. The updated model initially was recalibrated taking into account present and historical locations of both the Northwest and Northeast Plumes, which provided three specific model variations. The 3 models then were recalibrated to 17 different historical time periods back to 1995. The time periods each had specific measured plume conditions/characteristics to which the model was calibrated against. Seven of the time periods were used to calculate specific anthropogenic recharge to the RGA system from PGDP industrial operations for the model calibration. Of the 3 variations, the model variation with the best contaminant particle flow paths was selected for further use in selecting extraction well locations.

Specific constraints were placed on the analysis for determining optimized extraction well locations. Those constraints included these:

- Minimize contaminant migration to Northeast Plume from C-400 source area,
- Balance Northeast Plume extraction with extraction from Northwest Plume,
- Avoid major infrastructure such as major building locations and potential future location of CERCLA cell landfill, and
- Design well locations for both continued anthropogenic and no anthropogenic recharge conditions (uncertainty of future PGDP operations).

G:\GIS\PROJECTS\INE Plume\2014_TCE_plume_map_RAWPR1.mxd 8/24/2015

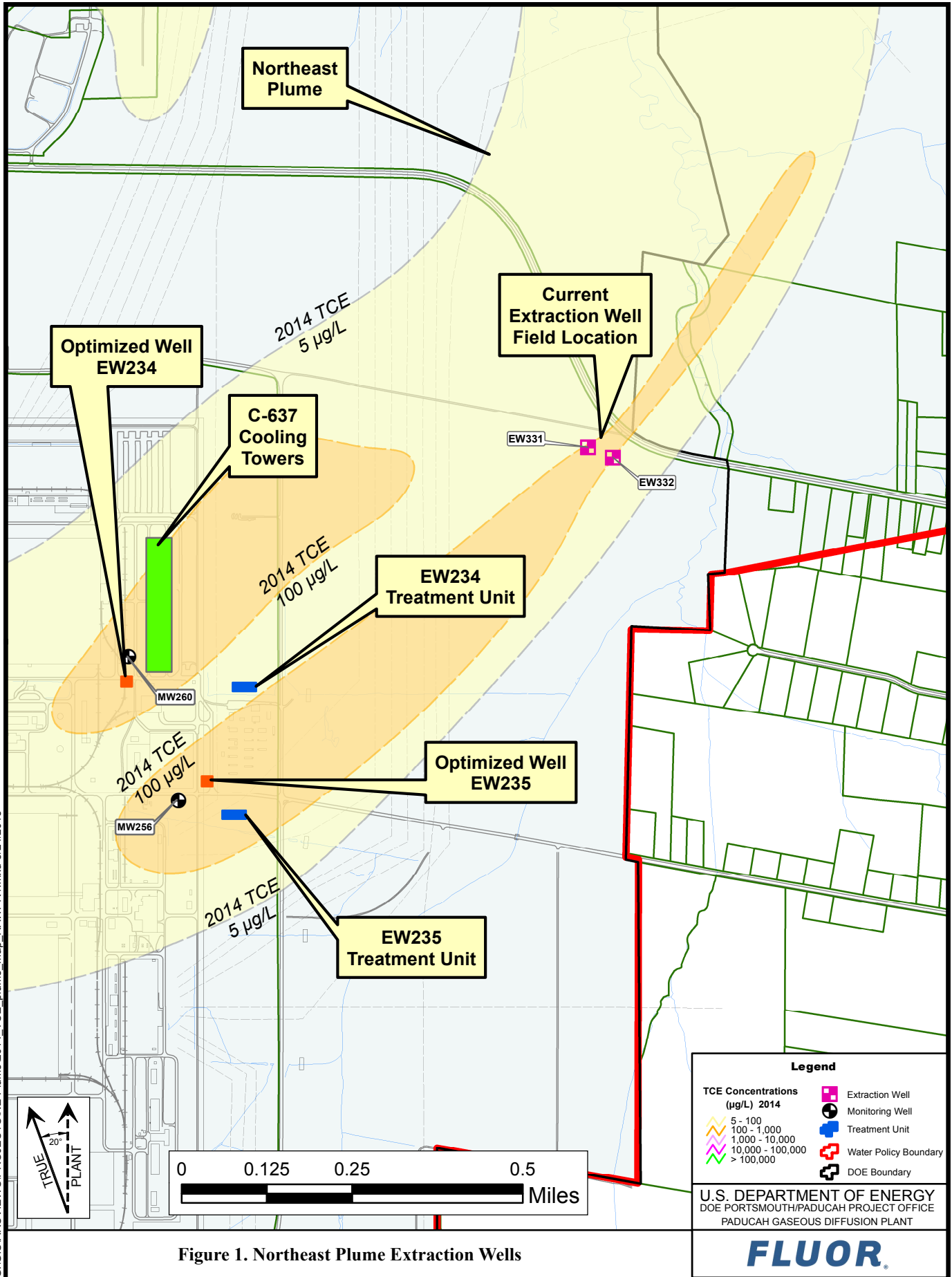

Figure 1. Northeast Plume Extraction Wells

Table 1. General Activities Governed by Procedures

Activity	Applicable Procedure
Accident/Incident Reporting	CP3-OP-2024, <i>Initial Incident/Event Reporting</i>
Analytical Laboratory Interface	CP3-ES-5004, <i>Sample Tracking, Lab Coordination, & Sample Handling</i>
Calibration of Measuring and Test Equipment	CP4-ER-0020, <i>Control and Use of Measuring Test Equipment for NW and NE Plume Operations</i>
Chain-of-Custody	CP4-ES-2708, <i>Chain-of-Custody Forms, Field Sample Logs, Sample Labels, and Custody Seals</i>
Collection of Samples	CP4-ES-0040, <i>Composite Sampling</i> CP4-ES-2101, <i>Groundwater Sampling</i> CP4-ES-2300, <i>Collection of Soil Samples</i> CP4-ES-2704, <i>Trip, Equipment, and Field Blank Preparation</i> CP4-HS-2000 <i>Industrial Hygiene Sampling</i>
Conducting Assessments	CP3-QA-1003, <i>Management and Self Assessments</i>
Control of Sample Temperature	CP4-ES-0043, <i>Temperature Control for Sample Storage</i>
Data Verification and Validation	CP2-ES-0026, <i>Wet Chemistry and Miscellaneous Analyses Data Verification and Validation</i> CP2-ES-0811, <i>Pesticide and PCB Analyses Data Verification and Validation</i> CP2-ES-5102, <i>Radiochemical Analyses Data Verification and Validation</i> CP4-ES-5103, <i>Polychlorinated Dibenzodioxins/Polychlorinated Dibenzofurans Verification and Validation</i> CP2-ES-5105, <i>Volatile and Semivolatile Analyses Data Verification and Validation</i> CP2-ES-5107, <i>Inorganic Analyses Data Verification and Validation</i>
Decontamination of Sampling Equipment	CP4-ES-2702, <i>Decontamination of Sampling Equipment and Devices</i> CP4-ER-2701, <i>Large Equipment Decontamination</i>
Document Control	CP3-OP-002, <i>Developing and Maintaining FPDP Performance Documents</i>
Evaluations for Suspect/Counterfeit Items	CP3-QA-1006, <i>Suspect/Counterfeit Items</i>
Fall Prevention	CP3-HS-2014, <i>Fall Prevention and Protection</i>
Field Logbooks	CP4-ES-2700, <i>Logbooks and Data Forms</i>
Graded Approach	CP3-QA-1001, <i>Graded Approach</i>
Handling, Transporting, and Relocating Waste Containers	CP2-WM-0661, <i>Fluor Federal Services, Inc., Paducah Deactivation Project, Transportation Safety Document for On-site Transport within the Paducah Gaseous Diffusion Plant, Paducah, Kentucky</i>
Health and Safety Plan	CP2-ER-0140, <i>Health and Safety Plan for the Southwest Plume Remedial Actions at the Fluor Paducah Deactivation Project, Paducah, Kentucky</i>
Hoisting and Rigging Operations	CP3-SM-0051, <i>Hoisting and Rigging</i>
Issue Management (includes corrective action)	CP3-QA-3001, <i>Issues Management</i>
Lithologic Logging	CP4-ES-2303, <i>Borehole Logging</i>
Powered Industrial Trucks	CP2-SM-0020, <i>Administrative Controls for Powered Industrial Trucks</i>
Quality Assured Data	CP3-ES-5003, <i>Quality Assured Data</i>
Quality Assurance Program	CP2-QA-1000, <i>Quality Assurance Program Description for FPDP</i>
Radiation Protection	CP2-RP-0001, <i>Radiation Protection Program Paducah Gaseous Diffusion Plant Deactivation Project, with Approval Letter</i>
Records Management	CP2-RD-0001, <i>Records Management and Document Control Program</i> CP3-RA-4002, <i>Administrative Record Process</i> CP1-OP-0002, <i>Document Control Requirements Document</i> CP3-RD-0020, <i>Document Control Process</i>

Table 1. General Activities Governed by Procedures (Continued)

Activity	Applicable Procedure
Revisions to Procedures or Work Packages	CP3-OP-0002, <i>Developing and Maintaining FPD Performance Documents</i> CP2-SM-1000, <i>Activity Level Work Planning and Control Program</i>
Shipping Samples	CP3-WM-3028, <i>Off-Site Shipping</i>
Suspend/Stop Work	CP3-HS-2009, <i>Stop/Suspend Work</i>
Temperature Extremes	CP3-HS-2000, <i>Temperature Extremes</i>
Training	CP2-TR-0100, <i>Training Program</i> CP3-TR-0102, <i>Conduct of Training</i> CP2-TR-0102, <i>Training Implementation Matrix</i> CP3-OP-0208, <i>Required Reading/Crew Briefing</i>
Transmission of Data	CP4-ES-1001, <i>Transmitting Data to the Paducah Oak Ridge Environmental Information System (OREIS)</i>
Vendor/Supplier QA Program	CP3-QA-2001, <i>Approved Supplier Selection, Evaluation, ASL Maintenance</i>
Waste Acceptance Criteria	CP2-WM-0011, <i>Waste Acceptance Criteria for the Treatment, Storage, and Disposal Facilities at the Paducah U.S. Department of Energy Site</i>
Waste Management and Disposition	CP3-WM-0016, <i>Waste Handling and Storage in DOE Waste Storage Facilities</i> CP3-WM-0437, <i>Waste Characterization and Profiling</i> CP3-WM-1037, <i>Generation and Temporary Storage of Waste Materials</i> CP3-WM-3010, <i>Waste Generator Responsibilities for Temporary On-Site Staging of Waste Materials at Paducah</i>

Utilizing these constraints, 18 potential new EW locations were loaded into the model and were provided minimum, maximum, and initial testing extraction rates. The Brute Force particle tracking optimization algorithm was utilized with the pumping rates to determine the optimal wellfield configuration based on which well location(s) captures the most dissolved-phase contaminant particles (representing dissolved contaminant mass only, not nonaqueous-phase liquid or sorbed-phase mass). The well location and extract rates resulted in numerous combinations of systems to evaluate. A number of additional issues and challenges were identified from the initial modeling and they are as follows:

- Need to prevent change in Northwest Plume migration pathway,
- Need to minimize number of EWs,
- Need to minimize extraction rates of wells, and
- Need to prevent dissolved-phase contamination from migrating into now uncontaminated areas.

In order to minimize these additional issues and challenges to the Northeast Plume, an evaluation was performed to determine the effect of the EW(s) at C-400. (Note: An EW at C-400 is not being installed as part of this current activity, but would be considered in the future as an option to address unfavorable TCE or Tc-99 migration from the source term at C-400 under Section 4 of the MOA for Resolution). The results indicated maximum effectiveness was encountered at extraction rates nearing 50 gpm from a C-400 EW. Simulation runs for multiple well scenarios were executed for one Northwest Plume well and typical, minimal, and maximum recharge conditions (with and without anthropogenic recharge) to determine the dissolved mass capture efficiency of contaminants migrating in both the Northeast and Northwest Plumes. Groundwater modeling predicts that mass capture will be in excess of 90% using existing Northwest Plume EW, EW232, pumping at 220 gpm; an extraction well located in the vicinity of C-400 pumping at 80 gpm; and the two Northeast Plume EWs located in the high-concentration portion of the Northeast Plume along the eastern edge of the PGDP industrial facility with a minimal combined extraction rate of 300 gpm (150 gpm each). (Note: The production goal for each new EW will be 150 gpm, for a total production of 300 gpm for the optimized IRA.)

The flow model recalibration and the process and results of the modeling to select the optimized extraction well locations were reviewed with remedial project managers for EPA and KY, as well as subject matter experts from EPA, KY, and DOE via Web-assisted teleconference meeting held July 26, 2012. The presentation information package for the work was provided at that time. EPA provided comments on the presentation and the presentation information package October 22, 2012. A comment response summary for the comments received on that modeling was developed and submitted to EPA and provided to Kentucky on December 12, 2012. Further discussions on the modeling were held among the FFA parties at the December 17, 2012, monthly meeting. No additional comments have been received on the modeling work.

2.2 WELLFIELD AND SYSTEM DESIGN

2.2.1 Key Design Changes

The Northeast Plume IRA optimization will implement the following design changes:

- The EW234 area TU will be used temporarily for treating groundwater from EW331 and EW332 due to the cessation of uranium enrichment operations at PGDP, which made the C-637 Cooling Towers unavailable.
- The new EW, EW234, will utilize the treatment capacity of the TU.
- The current EWs, EW331 and EW332, will be kept in good working condition until the FFA parties agree the maintenance no longer is necessary.
- The current EWs, existing associated tanks, pipelines, electronic controls, and power distribution system will not be abandoned at this time, but will be placed in a standby mode.
- The new EW, EW235, will utilize a similar skid-mounted treatment system, like the TU installed in 2013.
- Treated VOC-contaminated groundwater discharge will be through a maximum of two CERCLA designated outfalls. The receiving water body is Little Bayou Creek, which carries a Kentucky use classification of Recreational.
- New electrical power connections will be installed for the treatment units and EWs (EW234 and EW235).

2.2.2 Key Design Assumptions

The Northeast Plume IRA optimization will be designed based on the following key assumptions.

- The EW field volumetric flow rate is not limited by the treatment plant capacity, but will be limited by the EW well yield. The minimum flowrate is expected to be approximately 100 gpm, which may be adjusted in accordance with Section 4 of the MOA for Resolution. The optimized design will include an air stripping capability to remove the necessary volatile contaminant mass from the planned extraction volume.

- The two new EWs to be installed during the optimization process are identified as EW234 and EW235.
- EW234 and EW235 will be located near the eastern edge of the PGDP industrial facility and in the high-concentration TCE lobes of the Northeast Plume (see Figure 1), which have monitoring wells MW256 and MW260, respectively, nearby with RGA TCE contaminant average concentrations for the period 2000 to 2013 of 450 µg/L and 517 µg/L, respectively. Maximum TCE contamination levels experienced in these monitoring wells since 2000 are 870 µg/L (2/2009) and 680 µg/L (11/2005) for MW256 and MW260, respectively.
- The design parameters of both treatment systems will be an extracted groundwater flow rate of 200 gpm and capable of reducing an influent TCE concentration of 1,000 ppb to meet the effluent discharge requirements. The treatment systems will be skid mounted and include a high efficiency air stripper, air blower, effluent pump, influent bag filters, and process control system enclosed in a heated weather proof enclosure.

The planned treatment process accommodates the treatment of volatile organic compounds (primarily TCE and associated breakdown products) using air stripping, which essentially mimics the process previously provided by the C-637 Cooling Towers.

- Following treatment, the groundwater effluent from EW234 and EW235 will be released into tributaries to Little Bayou Creek through CERCLA outfall(s).
- New electrical power lines, pipelines, treatment equipment, and process controls will be constructed in support of the new EW fields.
- Wellfield design will be based on modeling results (Appendix C) and on geotechnical data (grain size analyses and lithologic logs) gathered from boreholes installed in close proximity to the proposed well locations.
- Pumping tests will not be performed as a basis for design of the new EWs. Pumping test data from historical tests performed at PGDP in the RGA and existing operational monitoring of the Northwest Plume Groundwater System and the Northeast Plume Containment System are available and have been used for groundwater flow model design and used for EW field placement.
- Electrical power will be provided by a public utility, from existing feeder lines supplying power in the area with additional lines and poles added as needed. No backup generator will be included since power interruptions are expected to be reasonable in frequency and duration such that contaminant mass not captured during the interruption will be minimal.
- No wetlands will be permanently impacted as a result of proposed locations for new extractions wells.
- The Northeast Plume IRA optimization activities will be constructed and performed in accordance with Northeast Plume IRA ROD applicable or relevant and appropriate requirements (ARARs) as modified and contained in the explanation of significant differences (ESD) (DOE 2016).
- The optimized Northeast Plume IRA will include installation of 14 monitoring wells with single screens to and 8 piezometers to evaluate performance and effectiveness of the optimized EWs. Seven of these monitoring wells will be located in a north-south transect located approximately 600 ft east of the C-400 Building. Samples from these transect monitoring wells will be used to establish

baseline TCE and Tc-99 concentrations before the EWs begin operation and to assess the impact of groundwater EWs on contaminant migration from source areas, including impacts to the groundwater divide east of C-400 Building. The transect monitoring wells will be sampled quarterly, both before and after EW extraction begins.

2.2.3 North-South Monitoring Well Transect

The MOA for Resolution requires that the optimization project address the concern that pumping in the optimized EWs may result in changes to groundwater flow direction impacting contaminant migration from source areas in the vicinity of C-400 (Figure 2.) This will be addressed through construction and monitoring of a transect of monitoring wells to the east of C-400 that will be used to assess potential changes in groundwater flow or source impacts (e.g., rising contaminant concentrations in the Northeast Plume, source migration, etc.). As appropriate, the FFA parties will consider adjustments (e.g., adjusting EW pumping rates) for the optimized Northeast Plume interim action to minimize these potential impacts. The MOA for Resolution requires the consecutive quarterly sampling of the north-south transect monitoring wells and also specific actions based on sampling analytical results.

The transect will consist of seven new RGA monitoring wells in a north-south alignment located approximately 600 ft east of the C-400 Building (Figure 3). The actual well locations will be field-located prior to construction to avoid nearby infrastructure. The field geologist will utilize soil cores from the RGA at the monitoring well location to determine the actual screen depth.

Transect Monitoring Well Locations

A robust dataset identifies TCE and Tc-99 as the primary dissolved contaminants associated with C-400. Both TCE and Tc-99 are good indicator parameters for dissolved contamination that may be derived from C-400.

The four primary known sources and influences of dissolved TCE and Tc-99 in the C-400 area are the following:

- A dissolved Tc-99 plume in the RGA migrating into the C-400 area from the south
- The southeast C-400 TCE source zone in the RGA
- North C-400 Tc-99 source zone(s) in the UCRS
- The Northwest Plume at C-400

Holistically, these four sources require focused monitoring of two areas, with TCE and Tc-99 common to both a south C-400 area and a north C-400 area. Groundwater monitoring in the proposed transect of monitoring wells that focuses on these two areas is appropriate to assess the potential for induced eastward migration of contamination related to operation of the optimized EWs.

To address the uncertainty of contaminant flow paths related to seasonal variations and the future development of the area of influence of the EWs, the transect includes seven monitoring wells in six locations (see Table 2 and Figure 3). These monitoring well locations are dictated largely by site infrastructure, but the locations and spacing between monitoring wells are consistent with the expected nature of potential, derived contaminant plumes, controlled in part by the operation of the EWs. Inter-well spacings are approximately 200 and 220 ft in the north end of the transect and 150 and 215 ft in the south end of the transect.

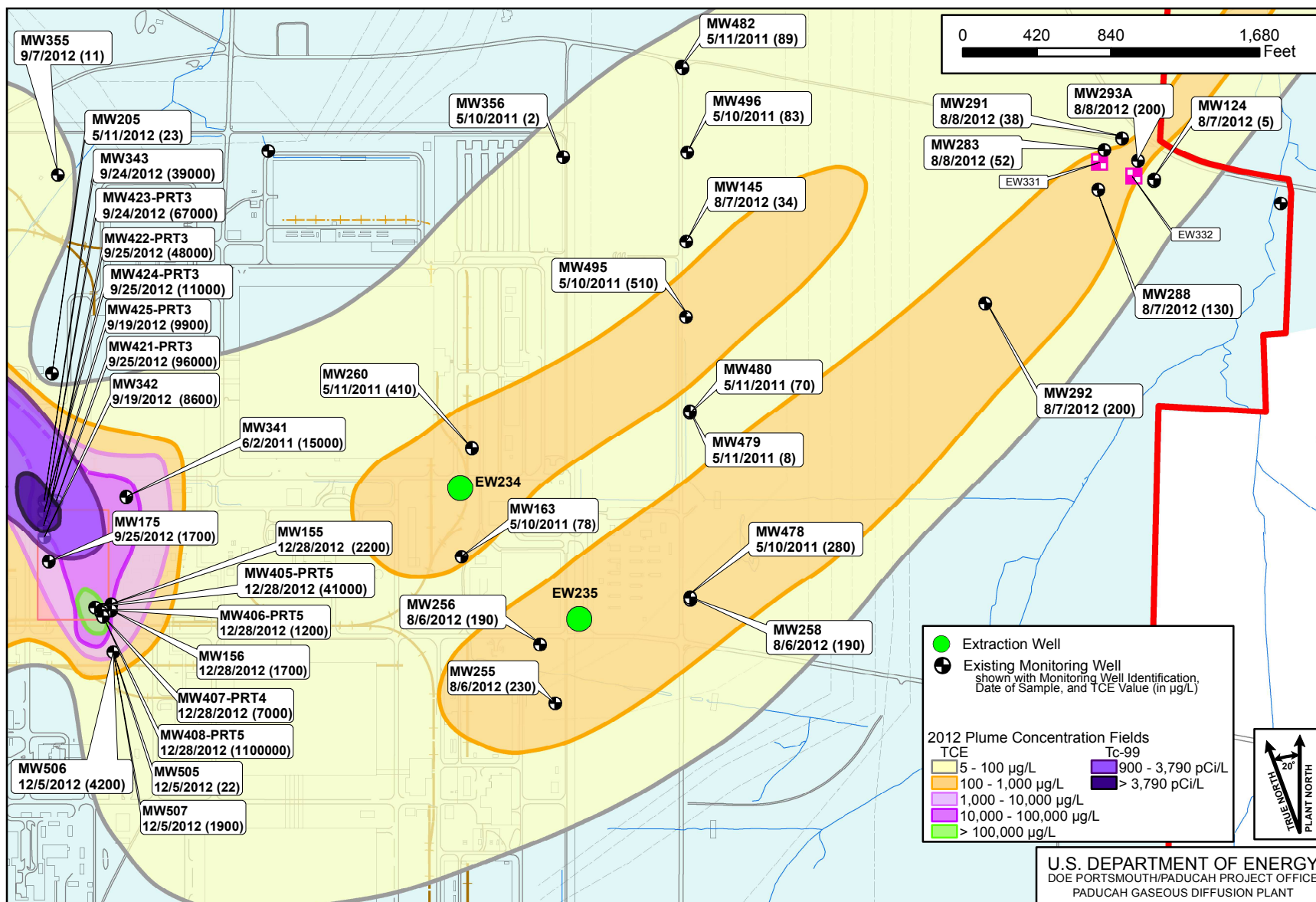

Figure 2. Optimized Extraction Wells Relationship to Tc-99 and TCE Contamination

U.S. DEPARTMENT OF ENERGY
DOE PORTSMOUTH/PADUCAH PROJECT OFFICE
PADUCAH GASEOUS DIFFUSION PLANT



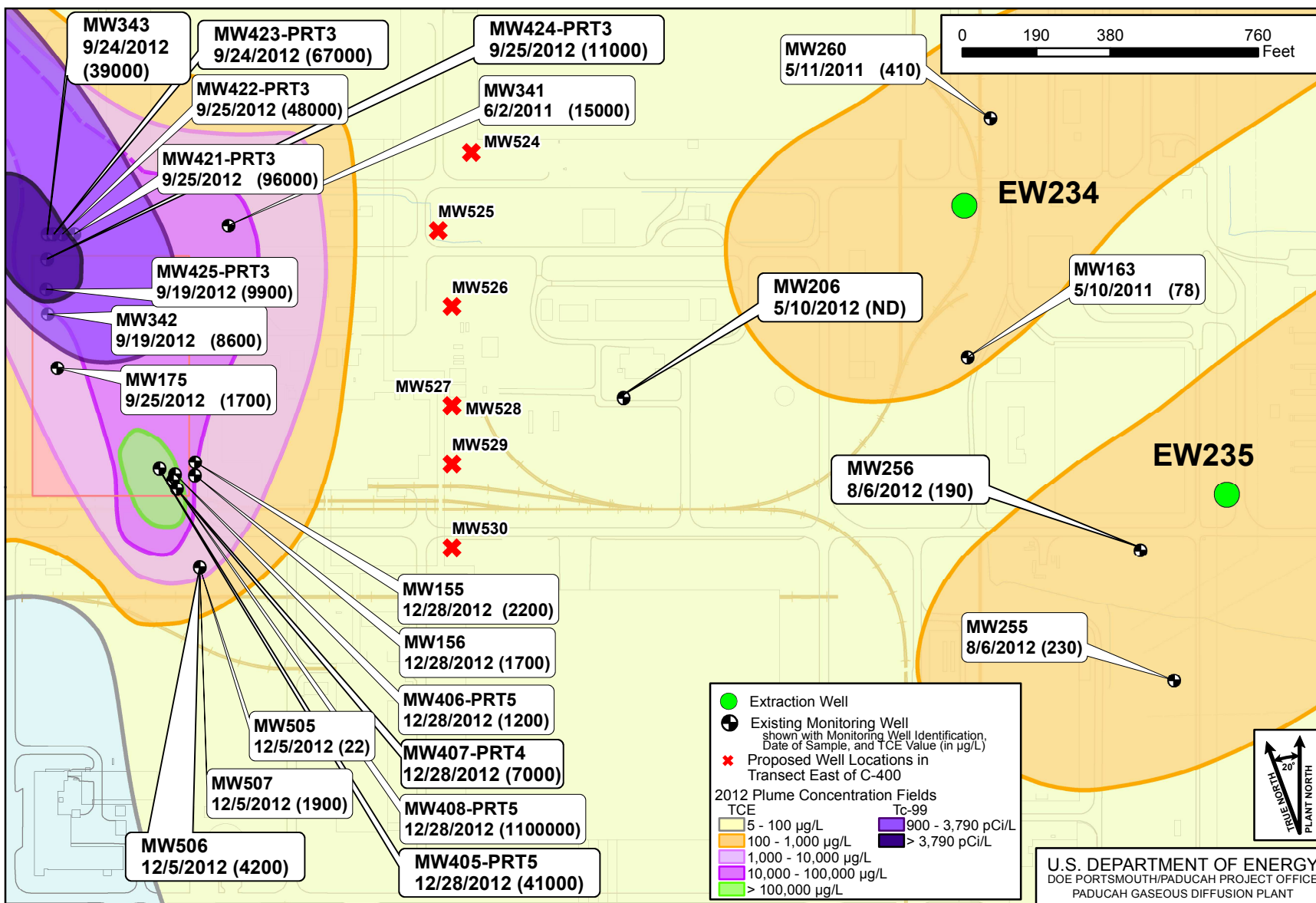

Figure 3. Transect Monitoring Well Locations East of C-400

U.S. DEPARTMENT OF ENERGY
DOE PORTSMOUTH/PADUCAH PROJECT OFFICE
PADUCAH GASEOUS DIFFUSION PLANT

FLUOR

Table 2. Approximate Location of Transect Monitoring Wells

Well	Plant Coordinates		Well Screen Interval
	Easting	Northing	
MW524 (north end)	-3,315	-875	middle RGA
MW525	-3,400	-1,075	middle RGA
MW526	-3,365	-1,270	middle RGA
MW527	-3,365	-1,525	middle RGA
MW528	-3,365	-1,525	lower RGA
MW529	-3,365	-1,675	lower RGA
MW530 (south end)	-3,365	-1,890	lower RGA

In the north C-400 source zone, available data and the conceptual site model indicate the highest levels of TCE are found in the lower RGA and highest levels of Tc-99 are found in the upper RGA.

In the area of the northern-most transect wells (600 ft or more east of the source zone), however, previous investigation analyses document that the highest Tc-99 levels occur within the middle RGA interval. The monitoring transect will consist of wells screened from 70 to 80 ft depth (middle RGA) in the 4 locations in the middle and northern end of the transect: MW524 through MW527. (The base of the RGA is approximately 90 ft below ground surface.) MW527 is included to provide monitoring of southern migration of the plume of contamination should future pump rates be reduced preferentially in EW234 (the north EW).

For the southeast C-400 source zone, it is anticipated that highest contaminant levels of both TCE and Tc-99 will occur in the lower RGA. (Recent remedial actions have remediated contaminant source zones in the UCRS and upper RGA.) Consequently, the transect will consist of wells screened across the lower 10 ft of the RGA in the three southern-most transect locations: MW528 through MW530. (The base of the RGA is expected to be at a depth of approximately 95 ft.)

2.2.4 Wellfield Design

Wellfield optimization modeling indicates that a two well configuration is optimal. The new wells, EW234 and EW235, will be located near the eastern edge of the PGDP industrial facility. Refer to Appendix A, Figure A.1, for the overall site plan and proposed well locations. EWs 234 and 235 will have a design capacity each of 150 gpm and will have treatment units capable of reducing an influent TCE concentration of 1,000 ppb to meet an effluent discharge requirement. The planned treatment process accommodates the treatment of volatile organic compounds (primarily TCE and associated breakdown products) using air stripping, which essentially mimics the process provided by the C-637 Cooling Towers. Because pumping at the optimized EWs may result in changes to groundwater flow direction that may impact contaminant migration from source areas, Sections 3 and 4 of the MOA for Resolution (DOE 2015a) allow the FFA Parties to consider adjustments to EW pumping rates and other actions to minimize these potential impacts, if necessary, for the optimized Northeast Plume interim action.

No additional treatment equipment is included in the planned TUs beyond what is currently require to replace the current air stripping capacity mechanism (see Appendix B, Air Dispersion Modeling). Refer to Appendix A, Figure A.2, for the treatment systems general arrangement drawing. Appendix C, Northeast Plume Extraction System Design and Evaluation, provides additional detail on the groundwater modeling process used to determine the optimum locations for the new EWs.

Each of the EWs will be designed similar to the Northwest Plume EWs. The EWs will penetrate fully the RGA and will be screened across an RGA thickness (estimated at a minimum of 60%) necessary to capture the full thickness of the plume at 150 gpm. Appendix A contains general engineering drawings that contain design details for the EW construction. Specific details such as the depths for screen locations, bentonite seals, pump depths, etc., will be determined following the drilling and lithologic logging of the wellbore.

Boreholes will be installed at designated distances from each of the EWs to further characterize the geologic settings. These boreholes will be converted to monitoring wells to support the performance monitoring of the IRA and chemical monitoring of the EW field. Detailed lithologic logs will be generated for these borings to support the geologic understanding of the areas and to complete the required Commonwealth of Kentucky's Uniform Well Construction Record. The well screen and filter pack designs for the EWs and supporting monitoring wells will be based on the existing available grain size results and additional grain size analyses to be obtained from drilling of associated monitoring wells.

2.2.5 Baseline Monitoring

Baseline monitoring for optimization will be established for the action by using a transect of seven monitoring wells (Section 2.2.2, Key Design Assumptions) constructed as part of the system of monitoring wells. The MOA for Resolution states the following:

The transect monitoring wells will be monitored for 4 consecutive quarters to establish baseline contaminant concentrations before the two newly relocated extraction wells begin operation. The anticipated contaminant concentrations of Tc-99 and TCE in the transect monitoring wells are expected to be no higher than 200 pCi/L and 600 ug/L, respectively. If baseline contaminant concentrations in any of the transect monitoring wells during the initial quarterly sampling are detected at twice the anticipated contaminant concentrations, then the FFA parties agree to temporarily suspend start-up of the extraction wells until the parties meet to evaluate the identified discrepancy, its potential impact on the NW Plume source actions and the planned NE Plume optimization project. The FFA parties will conduct an evaluation of the planned action and develop recommendations and a schedule for modifications of the optimized action to address the unanticipated contaminant concentrations. In the event the FFA parties decide that significant changes to the scope of the action under the ESD are necessary to continue with the optimization, then DOE shall continue implementing the current NE Plume Interim Remedial Action (Interim ROD 1995) and shall propose modification to the Interim Remedial Action through another ESD and RAWP Addendum. The PGDP Site Management Plan will be updated to reflect establishment of any enforceable milestones under the FFA such as due dates for the aforementioned Primary documents (DOE 2015a).

2.3 START-UP AND INTEGRATED TESTING

The Northeast Plume IRA System that is currently in place generally will continue to operate during construction of the optimization system components using the TU system that will be associated with EW234 upon completion of optimization. There will be short periods of downtime during tie-in of utilities and operating equipment to the existing system. These short periods of downtime for the existing system will be tracked and reported in the FFA semiannual report. After construction is complete, each equipment unit will be operationally tested, calibrated, and incorporated into the logic control system as part of construction acceptance activities. The C-614 Northeast Pump-and-Treat System and associated

EWs that currently are in place will be shut down following this construction acceptance testing to prevent interference with the optimized equipment during the remaining testing. An integrated system test will be performed on the optimized system to test the logic control system interlocks and effectiveness prior to restarting routine operations. The details of the start-up and testing plan will be documented in a revision to the O&M plan. EW234 and EW235 and the associated treatment systems each will undergo the same start-up, integrated testing, and construction acceptance testing prior to initiation of continuous operation. Using this approach, it is expected that the existing Northeast Plume IRA System will experience short, intermittent downtimes due to tie-ins, programming, and testing prior to the switchover to the optimized system.

2.4 OPERATIONS AND MAINTENANCE

Upon successful completion of the integrated testing and baseline monitoring consistent with the requirements of the MOA for Resolution, the new wells are expected to be routinely operated at a combined rate of approximately 300 gpm. Ongoing O&M will be performed in accordance with the revised O&M plan and operating procedures. The revised O&M Plan will document sampling and analysis requirements. Routine sampling, analysis, and data collection efforts as part of O&M are identified in Table 3. EPA and KY will have an opportunity to review revisions to the O&M plan prior to start-up of the new wells for routine operations. The MOA for Resolution states the following:

Once the two optimized extraction wells are online, contaminant concentrations in samples from the transect wells will be collected on a quarterly basis and reported to EPA and KDEP. If contaminant concentrations in any transect well's quarterly samples are determined to be increasing and may double above the established baseline within a year of the quarterly samples showing an increase, then potential changes in groundwater flow or source impacts (e.g. rising contaminant concentrations in the NE Plume, source migration, etc.) will be further examined and the FFA parties will consider adjustments (e.g. adjusting extraction well pumping rates) for the optimized NE Plume interim action to minimize these potential impacts. These adjustments are considered within the scope of the optimization under the ESD.

If the measures taken by the FFA parties (e.g. adjusting extraction well pumping rates) do not result in decreased or stabilized concentrations at the transect monitoring wells, or if such adjustments reduce the effectiveness of the optimized extraction wells or if Tc-99 concentrations continue to increase and are detected at twice their baseline concentration in any one (or more) of the transect wells for two consecutive quarters, then DOE must notify EPA and KDEP within 30 days of receiving sampling results or one of the other aforementioned conditions occurring. After EPA and KDEP have been notified, the FFA parties will discuss and evaluate options to address continued increase of groundwater concentrations and plume expansion. Within 1 year from the notification, DOE shall submit an ESD and RAWP Addendum as the Primary documents to undertake modification to the existing CERCLA Interim Remedial Action pursuant to the FFA to address the contaminated groundwater plume expansion and to prevent Tc-99 at levels above the MCL from further being pulled within the NE Plume.

The FFA parties will discuss whether to temporarily suspend operation of one or both of the extraction wells while determining the modifications to the CERCLA Interim Remedial Action to prevent further plume expansion. If FFA parties decide to implement a modification to the Interim Remedial Action to address the NE Plume contamination (including the expansion), then depending on the scope of the modifications it is possible

that the FFA parties will decide to shut-down the optimized pump and treat system in part or in its entirety. If a determination is made to shut down the optimized pump and treat system either before a modification to the Interim Remedial Action or as part of a modification to the Interim Action, then DOE shall reinstate implementation of the NE Plume Interim Remedial Action (Interim ROD 1995). DOE shall keep the extraction wells associated with the NE Plume Interim Remedial Action in good working condition until the FFA parties agree the maintenance is no longer necessary (DOE 2015a).

Table 3. Summary of Sampling, Analysis, and Data Collection

Sample point (s)	Parameters	Frequency ^a
EW234, EW235	Pump rates	Daily
	Water levels	Weekly
	TCE, Tc-99	Monthly
Monitoring Wells	TCE; 1,1-DCE; Tc-99; depth to water; dissolved oxygen; pH; specific conductance; temperature; redox; and turbidity	Quarterly
Piezometer Wells	Water levels	Quarterly
Air Stripper Liquid Effluent	TCE	Weekly
CERCLA Outfall	Flow, Total suspended solids, oil and grease, Total residual chlorine, temperature, TCE	Weekly
	Chronic toxicity, Tc-99	Quarterly
	pH	Weekly
	1,1-DCE	Weekly

Note: Sampling may be increased temporarily to support operational troubleshooting. Sampling will be suspended temporarily when the facility is shut down or if other operational conditions exist that would make sampling impractical.

^a Daily samples—Daily refers to normally manned operations, excluding weekends, holidays, or days when the facility is shut down.

Monthly—One sample per calendar month.

Quarterly—One sample every three months not to exceed four months/sample.

The optimized Northeast Plume system will continue operating until one the following occurs:

- The FFA parties mutually agree to cease operations.
- A CERCLA Five-Year Review determination supports ceasing operations, or
- The ROD associated with the Dissolved-Phase Plume supports ceasing operations.

2.5 MONITORING

As part of the optimization of the IRA, a groundwater monitoring program will be included in addition to baseline monitoring as discussed in Section 2.2.5. The intent of the program is to provide data to support an ongoing analysis of the contaminant types and levels and operational performance of the treatment unit and associated equipment. This data also will monitor any impact the optimized EWs have on groundwater flow or contaminant sources, as well as support the development of the CERCLA-required five-year reviews.

The network of new monitoring and piezometer wells when combined with existing monitoring wells will provide both hydraulic and chemical performance information such as the following:

- Contaminant concentration gradients within the RGA;

- Potential contaminant migration impacts to the Northwest Plume by the optimized Northeast Plume IRA extraction;
- Early warning of increases or decreases in target contaminants or presence of non-target contaminants such as Tc-99; and
- Effectiveness of capturing Northeast Plume contamination by the optimized EW locations.

Table 4 summarizes the goals for the Northeast Plume Optimization monitoring program during the operational period taken from the ROD (DOE 1995) and MOA for Resolution (DOE 2015a); the monitoring approach (hydraulic or chemical monitoring); and identification of the wells and piezometers that will be included.

Hydraulic Monitoring Network. Hydraulic monitoring is conducted to verify performance of the EW system and the impact of external hydraulic stresses with regard to capture zone development within the Northeast Plume and to measure potential areal impacts on contaminant source zones and adjacent plumes. Measurements of water level and gradients provide a basis, along with chemical monitoring, for refinement and optimization of system operation. Hydraulic monitoring results are immediately available after measurement for timely evaluation of adjustments to EW pumping rates. The Northeast Plume Optimization project will install eight new piezometers to provide hydraulic monitoring in the vicinity of the EWs. Figure 4 presents the locations of monitoring wells and piezometers included in the hydraulic monitoring well network.

Strategies for hydraulic monitoring consist of quarterly synoptic measurements of water levels, assessing the extent of the capture zone resulting from operation of the optimized Northeast Plume EWs, and a one-time, focused pumping test to measure aquifer properties. Revisions to the O&M Plan to support the optimization EWs will include the plan for the pumping test. The spatial distribution of the hydraulic monitoring well network provides sufficient water level and drawdown information to assess capture using analytical methods. This assessment may be used to support groundwater flow model refinement and recalibration.

With the cessation of uranium enrichment activities at PGDP and the associated reduction of water use, the magnitude of anthropogenic recharge upon the RGA is expected to decline. Model predictions indicate that lower rates of anthropogenic recharge will lessen the hydraulic gradient in the vicinity of the EW system and result in a larger capture zone. While the optimized EWs are expected to maintain the approximate current flow trajectories in the majority of the on-site Northeast Plume, significant changes in flow trajectories may occur in other areas. Hydraulic monitoring in the area north of the current extent of the Northeast Plume is warranted to assess the potential for developing a northward trajectory of a portion of the Northeast Plume.

Chemical Monitoring Network. Chemical monitoring will focus on several areas within and near the plume to achieve the monitoring objectives. Figure 5 shows the location of monitoring wells included in the chemical monitoring network. The MOA for Resolution (DOE 2015a) requires a north-to-south transect of monitoring wells located approximately 600 ft east of the C-400 Building to establish baseline contaminant concentrations before the two newly relocated EWs begin operation and later to assess the impact of the operation of the EWs on contaminant migration from source areas, including impacts to the groundwater divide east of C-400 Building. The Northeast Plume Optimization project will install seven RGA monitoring wells to create the monitoring transect, which are subject to the action limits established in the MOA for Resolution (DOE 2015a). In addition, the project will install five other monitoring wells upgradient of the EWs, screened in the middle and lower RGA, to monitor for the undesirable expansion of Tc-99 and TCE within the on-site Northeast Plume. This area of monitoring provides

Table 4. Northeast Plume Optimization Monitoring Network

Goals	Monitoring Approach		Monitoring Wells (MW) and Piezometers (PZ)		
1) Assessment of system performance (1995 ROD)					
TCE mass removal (2015 MOA for Resolution)	Chemical Monitoring	EWs	EW234 EW235	Screened across RGA Screened across RGA	
	Chemical Monitoring	Downgradient transect of monitoring wells	MW144 MW145 MW258 MW478 MW479 MW480 MW495 MW496 MW556*	LRGA URGA LRGA URGA URGA LRGA LRGA LRGA	
Control of NE Plume migration at the eastern edge of the PGDP industrial facility (2015 MOA for Resolution)	Hydraulic Monitoring	Monitoring wells and piezometers	MW163 MW260 PZ532* MW533* PZ534* PZ535* MW556*	LRGA LRGA LRGA LRGA LRGA LRGA	Assessment of EW234
			MW255 MW256 PZ540* PZ541* PZ553* PZ554* PZ555*	LRGA LRGA LRGA LRGA LRGA LRGA	Assessment of EW235
2) Engineering control to ensure protection of human health and environment (1995 ROD)					
	Chemical Monitoring	Downgradient monitoring wells	MW124 MW126 MW283 MW288 MW291 MW292 MW293A	LRGA MRGA LRGA LRGA LRGA LRGA MRGA	
3) Notification for institution of corrective measures should significant concentrations of Tc-99 be detected (1995 ROD)					
Undesirable expansion of Tc-99 and TCE within the NE Plume (2015 MOA for Resolution)	Chemical Monitoring	Transect monitoring wells	MW524* MW525* MW526* MW527* MW528* MW529* MW530*	MRGA MRGA MRGA MRGA LRGA LRGA LRGA	
		Upgradient monitoring wells	MW155 MW156 MW341 MW531* MW533* MW536* MW537* MW538* MW539*	LRGA-upgradient to EW235 URGA-upgradient to EW235 MRGA-upgradient to EW234 LRGA-north migration of plume LRGA-upgradient to EW234 MRGA-upgradient to EW235 LRGA-upgradient to EW235 MRGA-upgradient to EW235 LRGA-upgradient to EW235	
Changes to groundwater flow direction that may impact contaminant migration (i.e., TCE and/or Tc-99) from source areas (e.g., C-400 Building) (2015 MOA for Resolution)	Hydraulic Monitoring	Monitoring wells and piezometers	Hydraulic Monitoring wells and piezometers identified for Northeast Plume (Figure 4)		

*Identifies monitoring wells and piezometers to be installed for the Northeast Plume optimization project.

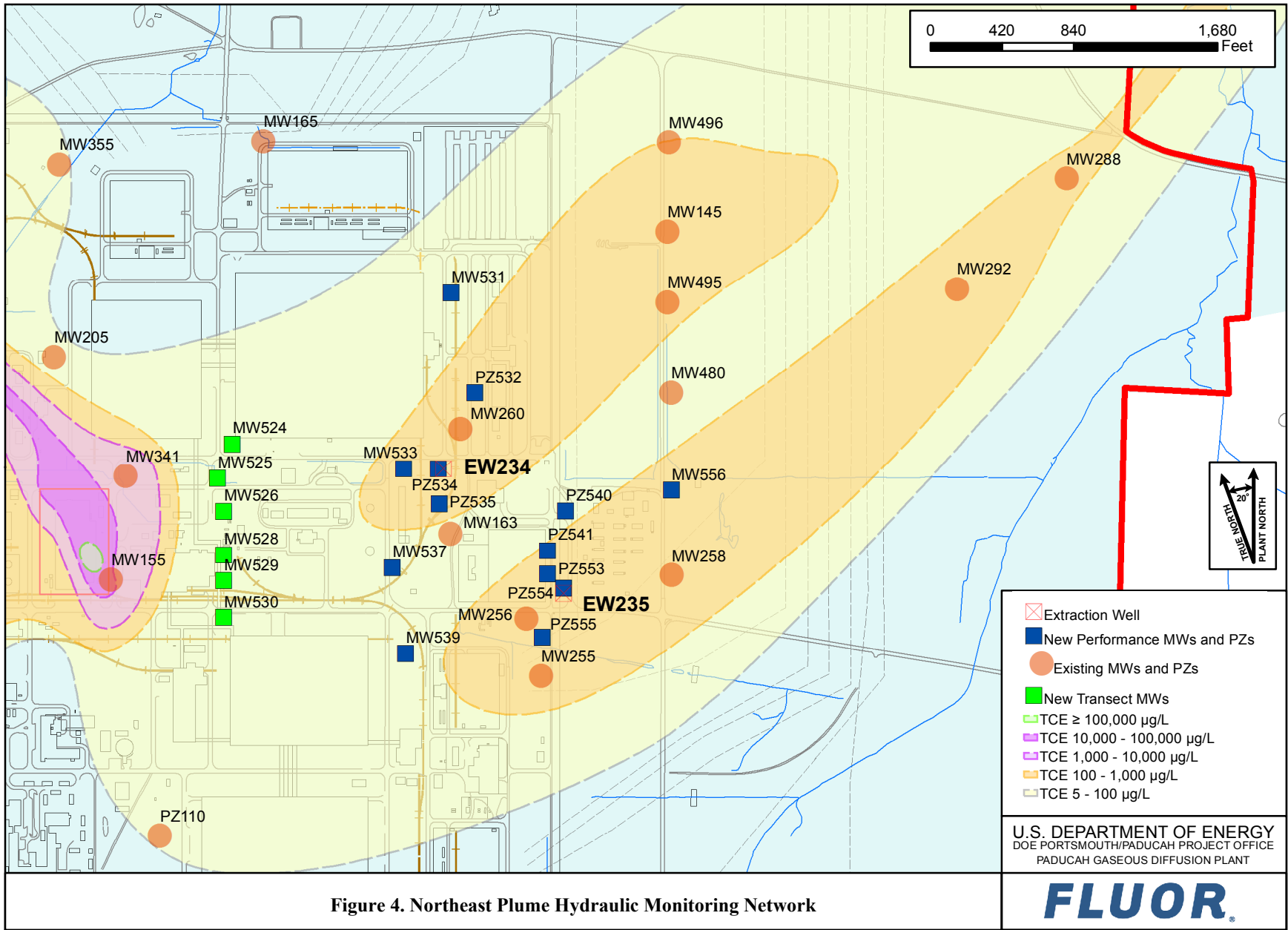

Figure 4. Northeast Plume Hydraulic Monitoring Network

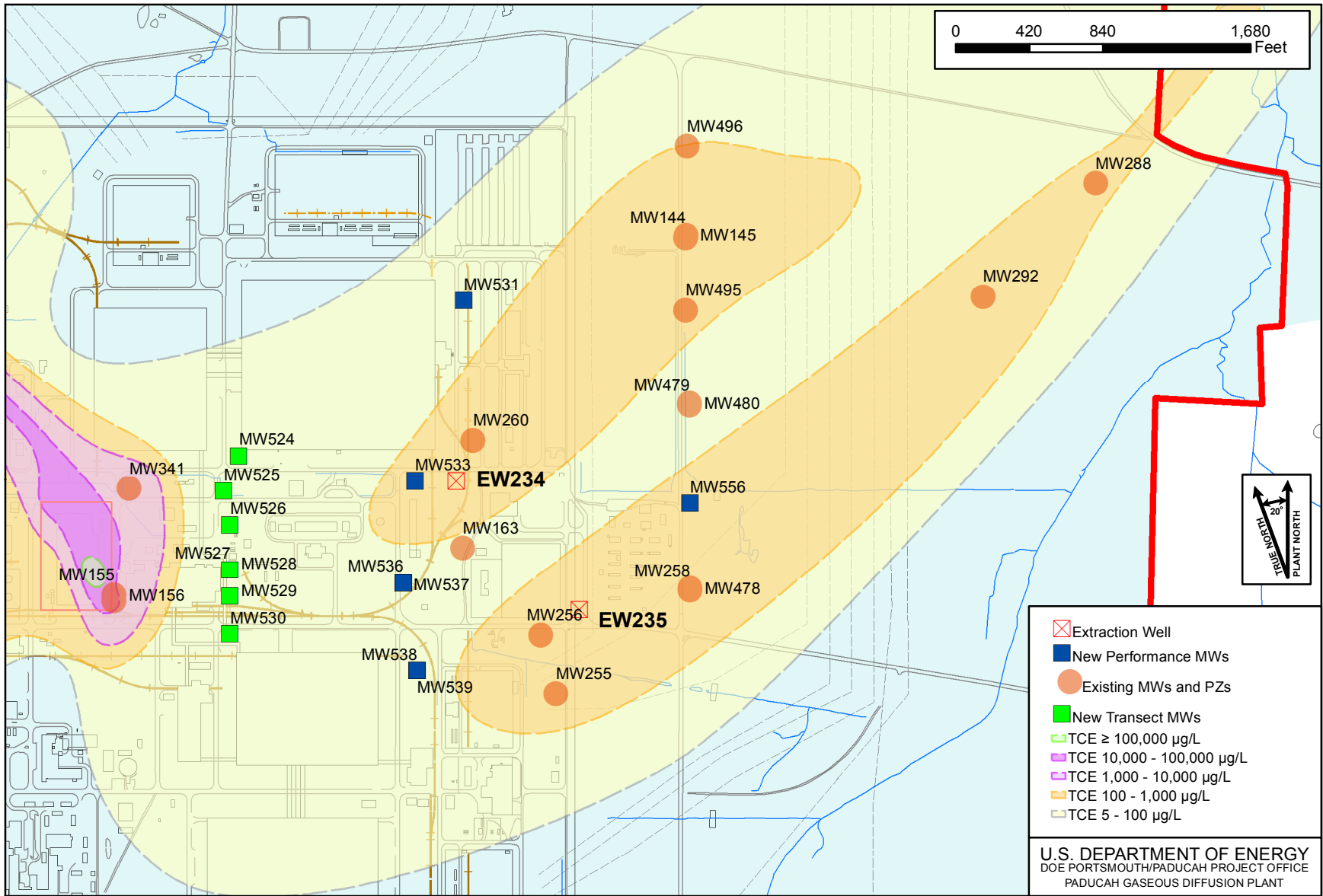

Figure 5. Northeast Plume Chemical Monitoring Network

U.S. DEPARTMENT OF ENERGY
DOE PORTSMOUTH/PADUCAH PROJECT OFFICE
PADUCAH GASEOUS DIFFUSION PLANT



notification for institution of corrective measures should significant concentrations of Tc-99 and/or TCE be detected.

The assessment of system performance includes monitoring to evaluate TCE mass removal and control of Northeast Plume migration at the eastern edge of the PGDP industrial facility. To achieve this goal, chemical monitoring will include both monthly sampling in the EWs to measure contaminant mass removal and sampling from a line of mostly existing monitoring wells located downgradient of the EWs to document the control of the plume. One new lower RGA well will be added to the downgradient line of monitoring wells as part of the Northeast Plume Optimization project. An additional, new lower RGA well will be installed north of the EWs to monitor for potential northward migration of the Northeast Plume.

Chemical monitoring also addresses monitoring as an engineering control to ensure protection of human health and environment.

2.6 WASTE MANAGEMENT AND DISPOSITION

Waste generated during drilling and construction activities will be managed and dispositioned in accordance with the waste management plan (WMP) and ARARs. Waste characterization will be performed using analytical results from waste sample analysis described in Section 7 and from process knowledge where applicable. Please refer to the WMP for additional detail concerning waste management and disposition.

3. PROJECT ORGANIZATION

The roles and responsibilities of the project team members are described below.

DOE Project Manager—Serves as the point of contact with regulatory agencies, and directs the overall completion of the remedial action in accordance with the approved RAWP.

Prime Contractor Project Manager—Serves as the primary point of contact with DOE to implement the remedial action. Performs work in accordance with the baseline scope and schedule and directs the day-to-day activities of Contractor personnel.

Quality Assurance Manager—Verifies all work is completed in accordance with the Quality Assurance Plan. Supports the development, implementation, and maintenance of the Quality Assurance (QA) Program. Verifies implementation of work is consistent with QA Rule; 10 *CFR* 830, Subpart A; DOE Order 414.1C; and applicable NQA-1 Consensus Standard.

Field Superintendent—Oversees all field activities and verifies field operations follow established plans and procedures.

Health and Safety Representative—Assists in the development of the health and safety (H&S) plan and activity hazard assessment, and verifies implementation of Worker Safety and Health Program and Integrated Safety Management Systems. The H&S specialist provides oversight for safety and health compliance performance.

Environmental Compliance Representative—Oversees implementation of the Environmental Management Systems. The environmental compliance representative provides direct support to the prime contractor project manager.

Waste Management Coordinator—The waste management coordinator (WMC) will manage all waste according to PGDP facility requirements and the WMP. WMC responsibilities include coordinating daily activities with field personnel, overseeing daily waste management operations and maintaining a waste management logbook.

Field Technical Staff—Provides direct support to the field superintendent concerning technical aspects of the project.

Subcontractors—Provide equipment and expertise during drilling, EW installation, treatment facility, and pipeline construction.

Training of project personnel will be in accordance with training matrices developed for this project as part of the PGDP work control process.

4. PROJECT SCHEDULE

The project schedule includes activities through initiation of quarterly sampling. Additional optimization activities (installation of EWs, a second TU, and installation of the remaining monitoring well system) will follow completion of the required four quarters of sampling data for baseline determination and completion of the assessment by the FFA parties. A generalized project planning schedule is shown in Table 5.¹

5. HEALTH AND SAFETY PLAN

The Northeast Plume IRA optimization project will incorporate by reference the H&S plan requirements from CP2-ER-0140, Health and Safety Plan for the Southwest Plume Remedial Action at FPD for performance of this optimization effort. The CP2-ER-0140 Southwest Plume Remedial Action H&S plan will be applicable, as written, with the following exception: replace references to the Southwest Plume with Northeast Plume IRA optimization project.

¹ Projected schedules for completion of activities set forth herein are estimates provided for informational purposes only and are not considered to be enforceable elements of the remedial action or this document. The enforceable milestones for performance of activities included as part of the remedial action are set forth in accordance with requirements of the FFA (EPA 1998). Any additional milestones, timetables, or deadlines for activities included as part of the remedial action will be identified and established independent of this RAWP, in accordance with existing FFA protocols.

Table 5. Project Planning Schedule

Activity	Target Date	Comments
Signed MOA for Resolution	7/31/2015	
Explanation of Significant Differences		
Submittal of D2/R1 to EPA/KY	8/31/2015	
Submittal of D2/R2 to EPA/KY	11/16/2015	
Regulatory Approval of D2/R2	1/13/2016	
Issue Public Notice of Availability		15 days after regulatory approval of D2/R2 ESD
Remedial Action Work Plan		
Submittal of D2/R1 to EPA/KY	8/31/2015	
Submittal of D2/R2 to EPA/KY	2/16/2016	It should be noted that because the regulatory due date of 2/13/2016, falls on Saturday, in accordance with Section I.L of the FFA, the deliverable is due to EPA and Kentucky on the following business day or 2/16/2016
Regulatory Approval of D2/R2	3/17/2016	30 days after submittal of D2/R2 RAWP to EPA/KY
Transect Wells Installation		
Field Work Start	7/25/2016	Approximately 130 days after regulatory approval of D2/R2 RAWP and ESD
Field Work End	9/29/2016	Approximately 70 days after field work start
Quarterly Sampling		
Quarter #1 Sampling	1Q/FY 2017	10 days after transect well installation (Approximately October 2016)
Quarter #2 Sampling	2Q/FY 2017	Approximately January 2017
*Finalize location of extraction and remaining well network after 2nd quarter sampling, data validated, and FFA parties review/consensus	February 2017	*Trigger Date—Approximately 2 months after Quarter #2 sampling is completed
Quarter #3 Sampling	3Q/FY 2017	Approximately April 2017
Quarter #4 Sampling	4Q/FY 2017	Approximately July 2017
Extraction and Remaining Wells Installation		
Field Work Start	3/24/2017	Approximately 35 days after FFA consensus to finalize location of extraction and remaining well network
Field Work End	6/29/2017	Approximately 100 days after field work start
Operation and Maintenance Plan		
Submittal of D3/R5 to EPA/KY	2Q/FY 2017	Approximately March 2017
Submittal of D3/R6 to EPA/KY	4Q/FY 2017	Approximately August 2017
Regulatory Approval of D3/R6	4Q/FY 2017	Approximately September 2017
Mech., Elect., and I/C Construction		
Field Work Start	4/3/2017	Approximately 40 days after FFA consensus to finalize location of extraction and remaining well network
Field Work End	9/6/2017	Approximately 155 days after field work start
System Start up and Testing Complete	10/11/2017	Approximately 35 days and field work ends
System Turnover to O&M Personnel	10/12/2017	
Post Construction Report		
Submittal of D1 to EPA/KY	1/11/2018	Approximately 95 days after system is fully operational
Submittal of D2 to EPA/KY	5/29/2018	
Regulatory Approval of D2	6/27/2018	

6. ENVIRONMENTAL COMPLIANCE PLAN

Environmental regulatory compliance will be facilitated during the implementation of this optimization project by adhering to ARARs. The modified interim remedy, which continues to capture and remove TCE and 1,1-DCE from within the high concentration area of the Northeast Plume, meets the threshold criteria of CERCLA Section 121 and the National Contingency Plan. The remedy continues to be protective of human health and the environment and complies with ARARs. As part of optimization of this IRA, ARARs included in the ROD pertaining to discharge through a KPDES-permitted outfall are being supplemented with ARARs to allow the utilization of up to two CERCLA outfalls for treated water discharge, as defined by the approved ESD (DOE 2016). The ARARs address requirements necessary to ensure the protection of the waters of the Commonwealth for the discharge of effluent through up to two CERCLA outfalls, as necessary. Figure 6 differentiates between the sample collection point at the CERCLA outfall, as the effluent compliance monitoring point subject to ARARs (e.g., TCE) and will occur prior to comingling with other waters and the performance monitoring sampling point for air stripper liquid effluent (for both TUs) to monitor TCE removal efficiency. Figure 7 shows the proposed path of a drop of treated wastewater effluent from the TUs as it flows to Little Bayou Creek, showing the location of the Northeast Plume wastewater discharge compliance monitoring point, specific CERCLA and KPDES Outfalls, and the point of entry for all other wastewater discharges along the route.

6.1 WITHDRAWAL OF PUBLIC WATERS

In accordance with Section XXI of the FFA, which requires that DOE identify permits that otherwise would have been required in the absence of CERCLA Section 121(e) (1) and the National Contingency Plan, this section identifies the Commonwealth of Kentucky requirement for a permit to withdraw water from a public groundwater source (*KRS* Chapter 151.150 and 401 *KAR* 4:010). Such a permit is not needed for this CERCLA action.

The Northeast Plume IRA optimization project, a CERCLA action, includes the installation of two new EWs for the purpose of extracting contaminated groundwater from the Northeast Plume. The wells will be installed in accordance with ARARs identified in the approved ESD, as well as those identified in the original ROD signed June 15, 1995, for the IRA.

The proposed locations of the new EWs, EW234 and EW235, are shown on Figure 1. Refer to Figure A.3 for design details for the EWs. Installation of the new wells and commencement of water withdrawal will be in accordance with the planning schedule shown in Section 4 and will be consistent with baseline monitoring requirements and stipulations contained in the MOA for Resolution. Withdrawal rates will be measured by flow meters installed at each EW. Combined groundwater extraction from EW234 and EW235 is not expected to exceed 300 gpm (or 432,000 gpd).

6.2 AIR EMISSIONS

Volatile organic compounds (VOC) will be emitted to the atmosphere by the air stripper component of the optimized Northeast Plume Treatment System. The emissions of VOC must comply with identified ARARs in Table 2 of the ESD (DOE 2016). Compliance with these ARARs is demonstrated by air dispersion modeling and by analysis of the groundwater to be treated. Any determination of the volatile organic hazardous air pollutants (VOHAP) concentration of the remediation material can be based on knowledge of the material. Based on existing data, it is expected that the VOHAP concentration of the

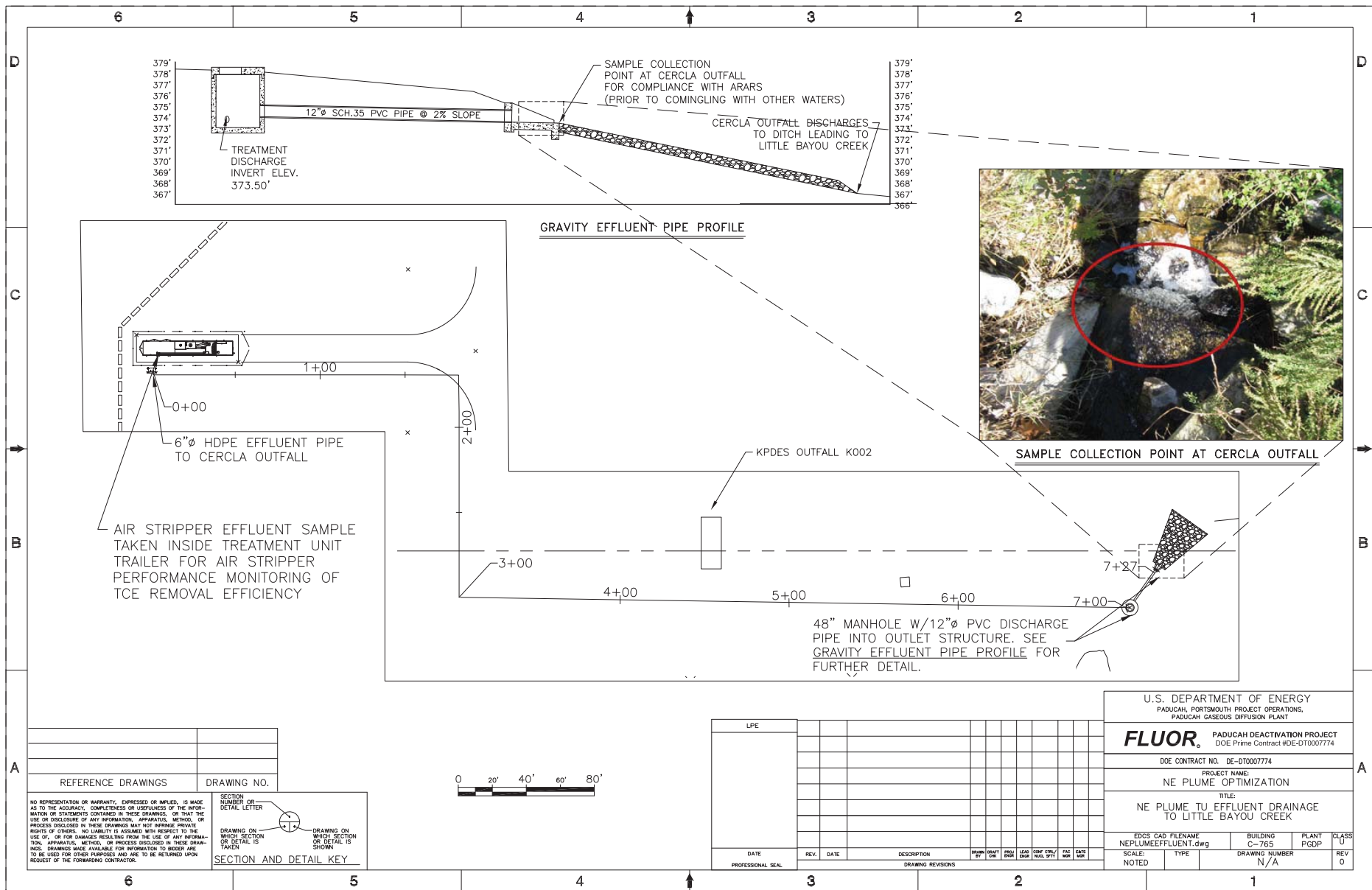
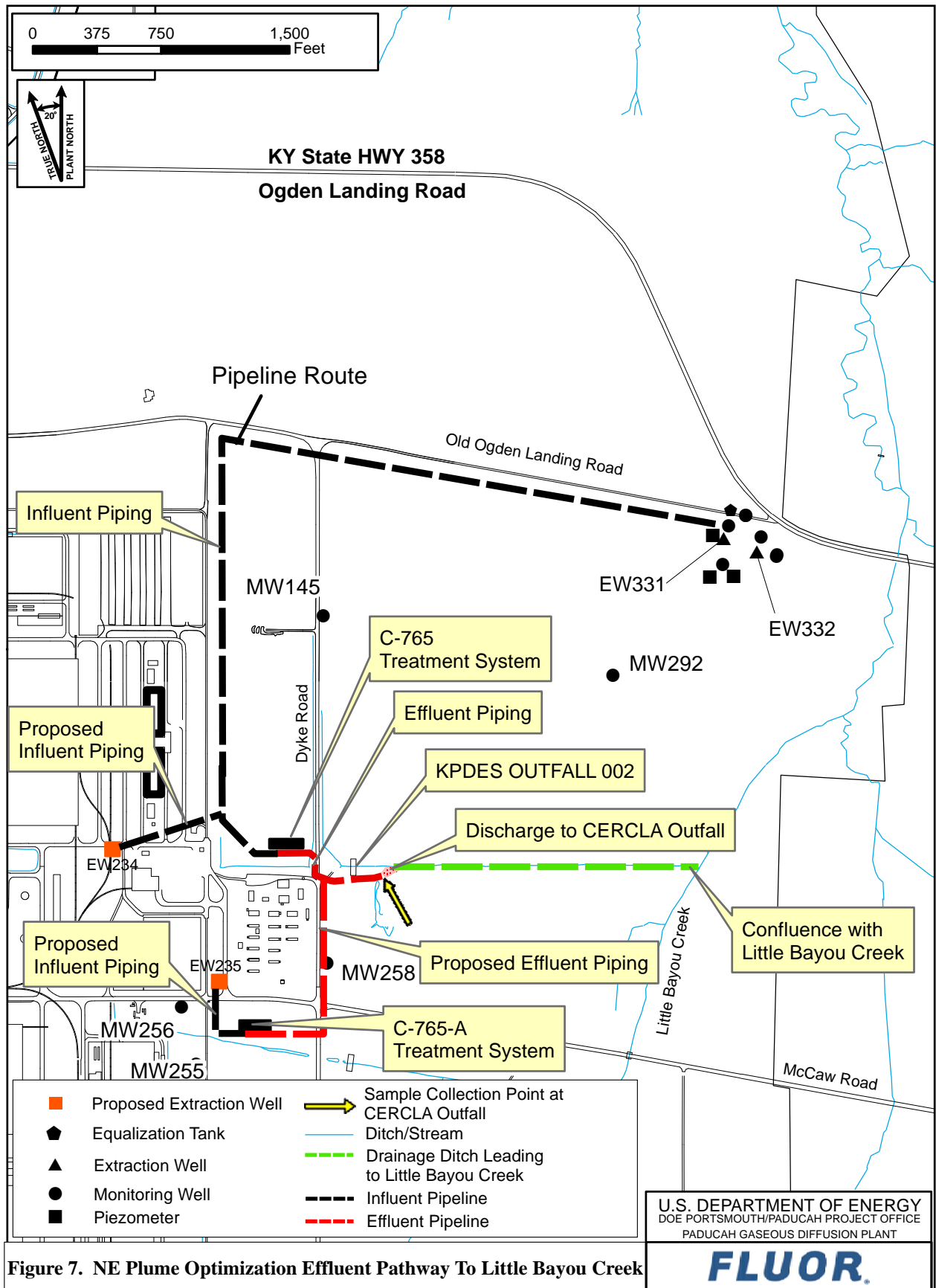

Figure 6. Northeast Plume TU Effluent Drainage to Little Bayou Creek



G:\GIS\ARCVIEWS\PROJECTS\NE Plume\NE PLUME MAP EFFLUENT MAP - Copy2 (REV F).mxd
2/4/2016

Northeast Plume groundwater is less than 10 ppmw. Historical data from the locations near the proposed new well locations show the highest anticipated concentration of TCE in the groundwater is less than 1 ppmw.

Air dispersion modeling was performed for the modular TUs that are to receive influent groundwater from the new EWs. The expected contaminant concentrations resulting from treatment of the influent groundwater were estimated based upon maximum equipment process treatment capacity. The results of these air dispersion modeling analyses show the estimated maximum annual average concentration for both modeling scenarios will be below the corresponding maximum allowable off-site concentrations of respective pollutants. Additionally, the allowable off-site concentration limit for TCE was developed using a lifetime (i.e., 70-year exposure period) per EPA's Regional Screening Level User's Guide. The duration of potential exposure associated with the operation of the associated TUs will be less than 70 years; therefore, emissions associated with this project are not expected to be harmful to the health and welfare of humans, animals, or plants. The results of the air dispersion modeling are contained in Appendix B.

As discussed in Section B.1.4., the removal efficiency of the air stripping units, as provided by the manufacturer, is 99% for VOCs. Additionally, nearby existing monitoring wells provide an estimate of the VOC concentration expected in the extracted groundwater that is below the maximum design loading of 1,000 ppb TCE. Once operations of the optimized system are initiated, the extracted groundwater will be sampled periodically and analyzed to provide the contaminant concentration to be stripped and released to the atmosphere. The specifics associated with the extraction water sampling will be included in the revised operations and maintenance plan for the optimized system. The combination of the periodic water sampling (pre- and post-air stripping) and the 99% removal efficiency provides the information on the contaminants released to the atmosphere. Based on the information above, there is no need for air emissions testing of the optimized IRA system at this time.

6.3 POST-RECORD OF DECISION DOCUMENTATION

The treated groundwater will be discharged through a newly created CERCLA outfall(s); therefore, an ESD will serve as the appropriate post-ROD documentation.

6.3.1 Explanation of Significant Differences

The treated groundwater will be discharged through a new CERCLA outfall(s). Supplemental ARARs were developed and are set forth in the associated ESD (DOE 2016).

6.3.2 Memorandum of Agreement for Resolution of Formal Dispute (July 2015)

During the development of this optimization project for the Northeast Plume IRA, the MOA for Resolution was agreed to and executed by the FFA parties July 31, 2015. The MOA for Resolution (DOE 2015a) acknowledges the concern that pumping in the optimized EWs may result in changes to groundwater flow direction that may impact contaminant migration from source areas.

6.3.3 Interim Remedial Action Metrics and Performance Monitoring

The Declaration of the ROD for the IRA for the Northeast Plume states the following as the primary objective:

...to implement a first phase remedial action as an interim action to initiate hydraulic control of the high concentration area within the Northeast Plume that extends outside the plant security fence.

In Section 2.6 of the ROD (Summary of Site Risks), the principal goal is stated as follows:

The principal goal of this remedial action is to implement control measures which will mitigate migration of the contaminants.

Plume mapping performed subsequent to expansion of the sitewide groundwater environmental monitoring system in 2009 and 2010, resulted in the identification of two sublobes of TCE that exceed 100 µg/L of TCE, which are migrating beyond the eastern plant security fence. Optimization of the Northeast Plume extraction system addresses the objective and goal, as stated above, by refocusing extraction at locations within a few hundred feet of the eastern plant security fence and within sublobes of the Northeast Plume that exceed 100 µg/L of TCE.

In addition to the goal and objective provided in the ROD, the design of the optimized extraction system for the Northeast Plume identified the following design objectives.

- **Minimize impacts to groundwater flow trajectory and associated dissolved-phase mass in the C-400 area.** Pumping at the optimized EWs may result in changes to groundwater flow direction that may impact contaminant migration from source areas. To meet this objective, the wellfield design process evaluated EW locations and pumping rate impacts to dissolved-phase mass in the RGA emanating from the C-400 source area. Dissolved-phase mass emanating from the C-400 source area represents the upgradient extent of the Northwest Plume; imposing extraction-based gradients that alter the trajectory of this mass by pulling it to the east is undesirable. The design process determined that pumping at the proposed EWs near the eastern security fence at the design rates would, over time, potentially redirect the trajectory of dissolved-phase mass at C-400. To mitigate potential trajectory impacts in the C-400 area, the optimization project will install 14 monitoring wells with single screens and 8 piezometers to evaluate performance and effectiveness of the optimized EWs. Seven of these monitoring wells will be located in a north-south transect located approximately 600 ft east of the C-400 Building. The MOA for Resolution states the following:

The Parties have reached consensus that the optimized extraction wells installed under the NE Plume Explanation of Significant Differences (ESD) should not cause or contribute to the undesired migration of Technetium-99 (Tc-99) contamination from the source area(s) (e.g., C-400 Building and Northwest (NW) Plume) and that actions (as further described below) may be undertaken to prevent any undesirable expansion of Tc-99 and TCE within the NE Plume....

...Once the two optimized extraction wells are online, contaminant concentrations in samples from the transect wells will be collected on a quarterly basis and reported to EPA and KDEP. If contaminant concentrations in any transect well's quarterly samples are determined to be increasing and may double above the established baseline within a year of the quarterly samples showing an increase, then potential changes in groundwater flow or source impacts (e.g. rising contaminant concentrations in the NE Plume, source migration, etc.) will be further examined and the FFA parties will consider adjustments (e.g. adjusting extraction well pumping rates) for the optimized NE Plume interim action to minimize these potential impacts. These adjustments are considered within the scope of the optimization under the ESD.

If the measures taken by the FFA parties (e.g. adjusting extraction well pumping rates) do not result in decreased or stabilized concentrations at the transect monitoring wells, or if such adjustments reduce the effectiveness of the optimized extraction wells or if Tc-99 concentrations continue to increase and are detected at twice their baseline concentration in any one (or more) of the transect wells for two consecutive quarters, then DOE must notify EPA and KDEP within 30 days of receiving sampling results or one of the other aforementioned conditions occurring. After EPA and KDEP have been notified, the FFA parties will discuss and evaluate options to address continued increase of groundwater concentrations and plume expansion. Within 1 year from the notification, DOE shall submit an ESD and RAWP Addendum as the Primary documents to undertake modification to the existing CERCLA Interim Remedial Action pursuant to the FFA to address the contaminated groundwater plume expansion and to prevent Tc-99 at levels above the MCL from further being pulled within the NE Plume.

The FFA parties will discuss whether to temporarily suspend operation of one or both of the extraction wells while determining the modifications to the CERCLA Interim Remedial Action to prevent further plume expansion. If FFA parties decide to implement a modification to the Interim Remedial Action to address the NE Plume contamination (including the expansion), then depending on the scope of the modifications it is possible that the FFA parties will decide to shut-down the optimized pump and treat system in part or in its entirety. If a determination is made to shut down the optimized pump and treat system either before a modification to the Interim Remedial Action or as part of a modification to the Interim Action, then DOE shall reinstate implementation of the NE Plume Interim Remedial Action (Interim ROD 1995). DOE shall keep the extraction wells associated with the NE Plume Interim Remedial Action in good working condition until the FFA parties agree the maintenance is no longer necessary (DOE 2015a).

- **Complement Northwest Plume extraction well capture zones.** This objective was met by **assessing** the balance between extraction rate, the number of extraction wells, and extraction well locations. The proposed configuration was found to attain the best balance of mass removal, extraction well configuration, and overall pumping rate.
- **Avoid locations potentially under consideration for waste disposal alternative evaluation.** This objective was attained by avoiding locations under consideration as part of waste disposal options evaluation (see slide 21 in Appendix C).
- **Manage anthropogenic recharge variability.** To address this objective, model recalibration was performed using multiple steady state and transient stress periods representing a range of anthropogenic recharge conditions. Model predicted capture zone dimensions are less during periods of relatively high anthropogenic recharge. With this in mind, and in an effort to reduce the potential for underestimating capture zone dimensions, post-calibration wellfield design development and testing used the October 2011 stress period to understand how capture zones for design configurations under consideration developed under periods of high anthropogenic recharge. Capture zone development under periods of comparatively lower anthropogenic recharge are predicted to be larger, encompassing a larger portion of the plume volume.
- **Develop a design that is effective to the extent practicable under conditions where PGDP operations are active (high anthropogenic recharge) and conditions reflective of a post-PGDP status (reduced anthropogenic recharge).** Wellfield design modeling tested conditions that were considered to be reflective of both active PGDP and post-PGDP status. Post-PGDP conditions are expected to include a substantial reduction in anthropogenic recharge, potential trends in plume

trajectory, and a corresponding increase in capture zone dimension, as the hydraulic flux from the site decreases. Plume trajectory monitoring will be required to assess potential changes in groundwater flow direction as anthropogenic recharge is reduced; however, under this scenario the combined pumping of the Northwest and Northeast Plumes extraction systems are expected to continue to effectively address the objectives of the interim remedial action.

Metrics for the optimized extraction system will be detailed in the optimization O&M Plan. Performance assessment metrics will be evaluated through the collection of key system performance data and will focus on determining if the extraction system is functioning as intended and is effective in addressing the goals and objectives of the interim remedial action. Performance assessment data collection will be used to (1) determine if the system is meeting the design objective and to identify if operational improvements are needed; (2) monitor changes in plume chemistry to determine if design objectives are being met with respect to plume capture, and avoidance of impacts to dissolved phase mass associated with the C-400 source area; and (3) assess extraction system hydraulic performance and potential changes in ambient hydrologic conditions that may influence system hydraulic performance.

The general approach to wellfield performance monitoring will utilize a combination of contaminant and hydraulic monitoring to assess system performance.

Contaminant monitoring will be performed by sampling a defined array of monitoring wells prior to system start-up to assess baseline conditions and subsequent monitoring at regular intervals during system operations. It is anticipated that the array of contaminant monitoring locations will include the following:

- The MOA for Resolution states, “the modified NE Plume interim remedial action will include installation (at a minimum) of five new RGA monitoring wells in a north-south transect approximately 600 feet east of C-400 Building ... These transect monitoring wells will be used to assess the impact of groundwater extraction wells on contaminant migration from source areas, including impacts to the groundwater divide east of C-400 Building.”
- Upgradient locations to assess contaminant concentrations east of the C-400 source area and associated dissolved phase mass in the RGA;
- Crossgradient locations to assess contaminant concentrations at locations potentially outside the lateral extent of the EW capture zones; and
- Downgradient monitoring wells located outside the downgradient extent of the EW capture zones to assess changes in contaminant concentrations as a result of groundwater extraction.

Hydraulic monitoring will be conducted to determine if the optimized EW system is performing as designed relative to capture zone development. Hydraulic monitoring will include the following:

- Baseline sitewide synoptic groundwater elevation surveys to assess conditions prior to extraction operations at the new optimized extraction well locations;
- System shutdown and restart testing to evaluate how capture zone development compares with model predicted capture zone dimensions; and
- Periodic sitewide synoptic groundwater elevation surveys to assess potential trends in ambient groundwater flow conditions due to changes in PGDP operations, optimization, or hydrologic trends.

6.3.4 Semiannual Progress Reports

Semiannual reports are prepared and issued to DOE within 30 days of the end of each six-month period, summarizing the data generated by activities associated with the NECPS. DOE submits progress reports to the Kentucky Department for Environmental Protection and EPA. For this project, effluent discharge and other information will be summarized in this report, which may include, but will not be limited to, TCE concentrations, maintenance performed, down time, TCE removed, effluent discharges, etc.

7. WASTE MANAGEMENT

This WMP provides information for the management and final disposition of waste material that will be generated as a result of the Northeast Plume IRA optimization project. The project includes the installation of two EWs and monitoring well system, construction of a treatment system to remove the TCE contamination, and construction of pipelines to transfer the groundwater to and from associated treatment equipment and to release locations.

This WMP addresses the management of waste from the point of generation through final disposition. The Northeast Plume IRA optimization project is part of the DOE prime contractor's ER program, and the DOE prime contractor shall be responsible for all waste management activities. Standard practices and procedures outlined in this WMP pertaining to the generation, handling, transportation, and storage of waste will comply with all DOE Orders, Resource Conservation and Recovery Act (RCRA), and Toxic Substance Control Act (TSCA) requirements.

Copies of this WMP will be available during fieldwork. The DOE prime contractor's ER WMC will be responsible for implementing procedures and requirements of this WMP.

The WMP for the Northeast Plume IRA optimization project underscores the following objectives:

- Management of project waste in a manner that is protective of human health and the environment;
- Minimization of waste generation;
- Compliance with federal, state, and DOE requirements; and
- Selection of storage and disposal alternatives.

Waste generated will be stored in CERCLA on-site waste storage areas (e.g., C-745-C, C-752-C, C-760, C-761, or other CERCLA storage facility) or within the RCRA area of contamination during the characterization period prior to disposal, when practical. CERCLA on-site waste storage areas will be operated in compliance with applicable or relevant and appropriate waste storage requirements. Wastewater will be transferred to storage pending characterization and treatment. All waste management activities must comply with this WMP; applicable procedures; the C-746-U Landfill waste acceptance criteria (WAC) (*Waste Acceptance Criteria for the Department of Energy Treatment, Storage and Disposal Units at the Paducah Gaseous Diffusion Plant, Paducah, Kentucky*, CP2-WM-0011); *Hazardous Waste Facility Operating Permit*—Permit No. KY8-890-008-982; and the WAC for off-site treatment, storage, and disposal facilities (TSDFs) designated to receive waste. The decision has not been made as to the final TSDF that will be used. Potential off-site TSDFs that may be used include, but are not limited to, *EnergySolutions*, Nevada National Security Site, Perma-Fix, and Waste Control Specialists.

During the course of this optimization project, additional PGDP and DOE waste management requirements may be identified. Necessary revisions to the WMP will ensure the inclusion of these

additional requirements into the daily activities of waste management personnel. DOE will inform the FFA parties of any substantive changes to the WMP. The criteria for document changes will be those found in the *Federal Facility Agreement for the Paducah Gaseous Diffusion Plant* (EPA 1998).

7.1 WASTE GENERATION AND PLANNING

7.1.1 Waste Generation

A variety of waste may be generated during this project, including soil cuttings and water from drilling activities in the Upper Continental Recharge System and RGA; dewatered soil and water from waste water filtration activities; personal protective equipment (PPE); sample residual (used sample bottles, etc.); grout; and construction and sanitary trash. The waste generated from field-related activities has the potential to contain contaminants related to known or suspected past operations; therefore, this waste must be stored and disposed of in accordance with ARARs. Waste that is likely to have either hazardous or radiological contamination typically will be stored on-site in containers in CERCLA waste storage areas in accordance with CP3-WM-1037, *Generation and Temporary Storage of Waste Materials*, during the characterization period and prior to treatment/disposal. Consistent with EPA Policy, the generation, storage, and movement of waste during a CERCLA project and storing it on-site does not trigger the administrative RCRA storage or disposal requirements. On-site waste storage areas will be managed in accordance with the substantive RCRA hazardous waste storage standards and in accordance with ARARs. Among the substantive requirements are compatible containers in good condition, regular inspections, containment to control spills or leaks, and characterization of run-on and run-off, either by process knowledge or by sampling. Final disposition of the materials will depend on final characterization. Table 6 summarizes estimated quantities and container types estimated to be generated in performing this project.

Waste generated during field activities will require a comprehensive waste-tracking system capable of maintaining an accurate inventory of waste. To prevent inappropriate disposal of waste, all generation, storage, and characterization information must be included in the tracking system. Specifically, the waste inventory must include the following information:

- Generation date
- Request for Disposal (RFD) number
- Waste origination location
- Waste matrix (solid, liquid)
- Waste description (soil, PPE, etc.)
- Quantity
- Storage location
- Sampling status
- Sampling results status
- Date of disposal

7.1.2 Soil from Drilling and Construction Activities

Solid waste drilling cuttings and excavated soil will be generated from installation of the new EWs, monitoring wells, and pipeline construction. Drill cuttings from the RGA, drill cuttings from boreholes in the industrial facility of PGDP, and soils excavated in the industrial facility of PGDP will be containerized as they are generated, labeled, and managed on-site according to the substantive requirements of RCRA, until they either are determined not to be RCRA waste, as provided in Section 7.9.1, or dispositioned to an appropriate disposal facility in accordance with ARARs. Waste

Table 6. Estimation of Waste

Waste Stream	Volume	Container Type and Quantity	Disposition Facility	Treatment Required [†]
Soil and Other Solid Media (Cuttings, Drill Tool Decontamination Solids, Lithologic Core, Dewatered Soils)	105 yd ³	6 roll-off/intermodal boxes	C-746-U or off-site facility	None or off-site LDR treatment*
Well Installation Water	26,000 gal	Mobile, Portable Containers	C-612 or C-765	C-752-C solids removal
Decontamination Water	10,000 gal	Mobile, Portable Containers	C-612 or C-765	C-752-C solids removal
Well Development Water	100,000 gal	Mobile, Portable Containers	C-612 or C-765	C-752-C solids removal
Personal Protective Equipment	6 yd	25 1A2X Drums	C-746-U or off-site facility	None or off-site LDR treatment
Grout/Concrete	2 yd	8 1A2X Drums	C-746-U or off-site facility	None or off-site LDR treatment

*Waste not meeting the definition of hazardous waste at the point of generation and meeting the requirements of the WAC may be disposed of in the C-746-U Landfill with no further treatment. Waste meeting the definition of hazardous waste at the point of generation must be treated to LDR standards prior to landfill.

[†]Wastewater will undergo further treatment, as necessary, at C-612 Northwest Plume or C-765 Northeast Plume treatment facilities or it also may be treated at C-752-A Waste Management facility prior to release.

minimization also will be facilitated by not containerizing material known to originate from clean area (e.g., above the RGA or outside the industrial facility of PGDP). Wastes will be stored at CERCLA storage areas and will be managed according to the substantive requirements of RCRA and in accordance with ARARs. The solid waste will be sampled and analyzed as described in Section 7.9 for proper waste determination.

7.1.3 Personal Protective Equipment

PPE will be worn as specified in the H&S plan by personnel performing the field tasks. While site personnel use procedures and best management practices to minimize opportunities for contacting contaminated media and equipment, it is likely that some PPE or related debris (e.g., plastic sheeting) will come into contact with contaminated materials during the remediation process. Process knowledge, visual inspections, or direct sampling will be used to characterize PPE and any related debris. Based on the results of the characterization, any PPE or the related debris determined by site personnel to be contaminated by a listed waste or exhibiting a RCRA characteristic will be managed as hazardous waste, decontaminated, or a no longer contaminated-with determination will be made pursuant to Section 7.9. In cases where site personnel conclude, based on the above characterization process, that the PPE or related debris has not been contaminated by a listed waste or does not exhibit a characteristic, then the materials will not be considered a RCRA hazardous waste.

7.1.4 Grout

Bentonite grout is used to hold new well casing in place. There is a potential for grout to become waste due to test pours, spillage, or leftover material in a batch following a pour. Grout will be packaged separately from other waste streams and managed as non-hazardous material.

7.1.5 Well Installation/Development/Decontamination/Sample Residual Water

Dual rotary drilling technology will be used to drill the EWs and monitoring wells. With dual rotary drilling, the bit is advanced slightly behind the bottom of the outer casing. Compressed air is used to force soil cuttings and groundwater up the annulus between the drill pipe and casing. These cuttings and water are diverted through a discharge swivel and directed via flexible hose to a cyclone separator. Soil cuttings and water fall out of the bottom of the separator into a container while air is released from the top of the separator.

Newly installed EWs, piezometers, and monitoring wells will be developed to remove fine material from the formation around the well screen. This process will generate water with high suspended solids content. Well development water will be processed at the drill site for suspended solids and may be stored in dual wall holding tanks until verified that it meets the appropriate acceptance/discharge criteria for suspended solids before transfer to the C-765 treatment trailer and discharged through CERCLA Outfall 001 or transported to C-612 and discharged through C-612 and KPDES Outfall 001. Prior to discharge, additional treatment, as necessary, will be treated at C-752-A Waste Management facility. Additional waste water with suspended solids will be generated as a result of drilling equipment decontamination activities.

Wastewater generated during drilling, well development, and decontamination activities will be processed through particulate filters at the drill site or accumulated and stored on-site until it can be processed for removal of suspended solids, as necessary. The solids will be classified according to the results of water and soil analyses. The filtered water will be pumped to dual wall holding tanks until verification that it meets the appropriate acceptance criteria for suspended solids before transfer to the on-site C-612 Northwest Plume Groundwater System, C-765 Northeast Treatment trailer, or the C-752-C Decontamination Facility. Potential contaminants of concern in this filtered waste water will be assumed to be consistent with those in the Northeast Plume groundwater.

Wastewater generated during drilling, well development, and decontamination activities that has undergone wastewater treatment and meets the KPDES discharge limits shall be considered to “no longer contain” listed hazardous waste (e.g., TCE), as discussed in Section 7.9.1. This treated wastewater may be directly discharged to permitted KPDES Outfall 001 or on-site ditches that flow to permitted KPDES Outfall 001 or transferred to C-765 Northeast Treatment trailer.

7.1.6 Miscellaneous Noncontaminated/Clean Trash

DOE has implemented waste management activities for the segregation of clean trash (i.e., trash that is not chemically or radiologically contaminated). Examples of clean trash are office paper, aluminum cans, packaging materials, glass bottles not used to store potentially hazardous chemicals, aluminum foil, and food items. During implementation of this WMP, clean trash will be segregated according to those guidelines and then collected and recycled/disposed of by the WMC when it has been approved for removal.

7.2 WASTE CHARACTERIZATION

Waste characterization will be performed based on sample analyses, evaluation of existing data, or process knowledge. Refer to Section 7.9 of this document for more information on waste characterization sampling.

7.3 CONTAINERS, ABSORBENT, AND DRUM LINERS

WAC approved absorbent will be used if necessary to ensure there are no free liquids in the waste being disposed of in the C-746-U Landfill. Table 6 summarizes container types and estimated quantities of containers.

7.4 WASTE MANAGEMENT ROLES AND RESPONSIBILITIES

7.4.1 Waste Management Tracking Responsibilities

Waste generated during remediation activities at PGDP is tracked using a system capable of maintaining an up-to-date inventory of waste. The inventory database is used to store data that will facilitate determination of management, storage, treatment, and disposal requirements for the waste.

7.4.2 Waste Management Coordinator

The WMC will ensure that all waste activities are conducted in accordance with PGDP facility requirements and this WMP. Responsibilities of the WMC also include coordinating activities with field personnel, overseeing daily waste management operations, and maintaining a waste management logbook that contains a complete history of generated waste and the current status of individual waste containers. Designated waste operators also may complete the waste management logbook.

The WMC will ensure that procurement and inspection of equipment, material, or services critical for shipments of waste to off-site TSDFs are conducted in accordance with appropriate procedures. In addition, the WMC will ensure that wastes are packaged and managed in accordance with applicable requirements (e.g., the WAC for the landfill).

Additional responsibilities of the WMC include the following:

- Maintaining an adequate supply of labels;
- Maintaining drum inventories at sites;
- Interfacing with all necessary personnel;
- Preparing RFDs;
- Tracking generated waste;
- Ensuring that drums are properly labeled;
- Coordinating waste recycling, disposal, or transfers;
- Sampling waste containers to characterize wastes;
- Coordinating pollution prevention and waste minimization activities;
- Transferring characterization data to DOE prime contractor's data manager; and
- Ensuring that temporary project waste storage areas are properly established, maintained, and closed.

Waste item container logs will be used to document each addition of waste to containers.

The WMC and waste operators will perform the majority of waste handling activities. These activities will involve coordination with the DOE prime contractor IRA project manager or designee who will perform periodic inspections to verify that drums are labeled in accordance with the WMP guidelines.

The WMC will be responsible for ensuring characterization sampling of the waste in accordance with the procedures outlined in this plan. When sampling is complete, the WMC will transfer the waste into the waste holding area established for this project, if necessary.

The WMC or designee will complete all chain-of-custody forms relating to the shipment of waste characterization samples. The chain-of-custody forms, along with the associated samples, will be transferred to the personnel responsible for packaging and delivery of the samples.

The WMC or designee will inspect the decontamination facility to ensure that waste generation is minimized to the extent possible and that the transfer of liquids to the waste holding area is arranged such that the work schedule is not delayed. If improper waste-handling activities are observed, the WMC will notify the DOE prime contractor project manager and temporarily stop decontamination activities. All activities not in compliance with the WMP will be identified and corrected before decontamination activities continue.

7.4.3 Coordination with Field Crews

The WMC will be responsible for daily coordination with project field crews involved in activities that generate waste. The WMC will inspect work sites to oversee the waste collection and will verify that procedures used by the field crews comply with the WMP guidelines. Deficiencies will be documented in the waste management logbook, and appropriate direction will be given to the field crews. Site visits will be documented in the field logbook.

7.4.4 Coordination with Treatment, Storage, and Disposal Facilities

The waste streams generated on the Northeast Plume IRA optimization project may be managed and disposed of in a variety of ways depending on characterization and classification. Waste will be temporarily stored on-site as previously discussed. Waste that is to be shipped to an off-site TSDF must be done so in accordance with applicable DOE contractor procedures and U.S. Department of Transportation requirements.

7.4.5 Waste Management Training

The WMC and other project personnel with assigned waste management responsibilities will be trained and qualified in accordance with the approved project training matrix.

7.5 TRANSPORTATION OF WASTE

The areas where the Northeast Plume IRA optimization activities will be conducted are on DOE property. Transportation of waste on DOE property will be conducted in accordance with applicable DOE, PGDP, and DOE Contractor policies and procedures. In the event that it becomes necessary to transport known or suspected hazardous waste over public roads, coordination will be initiated with PGDP Security, as necessary, which may result in the temporary closing of roads. Off-site transportation/disposal of waste will be made in accordance with the substantive and administrative requisites of applicable regulations.

7.6 SAMPLE SCREENING

7.6.1 Screening of Analytical Samples

During the course of the Northeast Plume IRA optimization field activities, screening of waste samples will be performed to protect the health and safety of on-site personnel and to ensure compliance with regulatory requirements.

7.6.2 Field Screening

Field screening for health and safety will be conducted during project field activities and sample collection. The field screening to be performed will incorporate the use of instrumentation to monitor for organic vapors, as well as radiation meters capable of detecting alpha and beta/gamma radioactivity. An elevated reading from field monitoring may be cause for reevaluation of current waste classification, labeling, and handling activities.

7.6.3 On-Site Laboratory Radiation Screening

A fixed-base laboratory will analyze all waste characterization samples. All samples to be shipped off-site for laboratory analysis will be screened for radiation at an on-site laboratory before shipment and will receive approval for off-site shipment.

7.7 WASTE MINIMIZATION

Waste minimization requirements that will be implemented, as appropriate, including those established by the 1984 Hazardous and Solid Waste Amendments of RCRA; DOE Orders 5400.1, 5400.3, 435.1, and 458.1; and requirements specified in the project waste management plan and procedures concerning waste generation, tracking, and reduction techniques will be followed.

To support the DOE contractor's commitment to waste reduction, an effort will be made during field activities to minimize waste generation, largely through ensuring that potentially contaminated waste material is localized and is not allowed to come into contact with clean material. Such an event could create more contaminated waste. Waste minimization also will be facilitated by not containerizing material known to originate from clean areas, such as above the RGA or outside the industrial facility of PGDP.

Solid wastes such as Tyvek[®] coveralls and packaging materials will be segregated. An attempt will be made to separate visibly soiled coveralls from clean coveralls. In some instances, partially soiled coveralls can be cut up and segregated. Other solid waste will not be allowed to contact potentially contaminated soil waste. Efforts will be made to keep Tyvek[®] coveralls clean, reuse clean coveralls, and use coveralls only when necessary. Proper waste handling and spill control techniques will help minimize waste, particularly around decontamination areas where water must be containerized.

7.8 HEALTH AND SAFETY ISSUES RELATED TO WASTE ACTIVITIES

Waste management activities will be conducted in compliance with health and safety procedures documented in the H&S plan.

7.9 WASTE SAMPLING AND ANALYSIS PLAN

This plan describes sampling to support analysis of waste generated from the installation of 2 EWs, 8 piezometers, and 14 monitoring wells. Solid waste will be generated from drill cuttings, while aqueous liquids (groundwater, well purge and development water, and sample residuals water) also will be generated during drilling. The project team will perform sampling work in accordance with contractor-approved procedures and work instructions. Procedures related to the sample collection and additional procedures are referenced in Section 2, Table 1.

Wastes generated from sites designated as potentially contaminated will be characterized to classify the waste for proper handling, record keeping, transfer, storage, and disposal. Waste analyses will be performed using the EPA approved procedures, as applicable. Analyses required for hazardous waste classification will reference EPA SW-846 or other EPA-approved methods, as required. Wastewater analyses will reference the applicable analytical requirements in PGDP's KPDES permit, Clean Water Act, or Safe Drinking Water Act. QA/quality control (QC) requirements and data management requirements, as specified in Sections 7.9 and 7.10 of this document, will be followed for waste characterization sampling activities.

Characterization requirements and guidance are provided in the site WAC, CP3-WM-0437, *Waste Characterization and Profiling*, and CP3-WM-1037, *Generation and Temporary Storage of Waste Materials*. Section 7.9.2 lists the analytical testing methods that will be used for analysis. The WMC will coordinate with the DOE contractor Northeast Plume IRA optimization project manager and DOE contractor sample and data management group for required analyses and guidance on collection and transfer of characterization samples to a Sample Management Office-approved fixed-base laboratory that has been audited under DOE Consolidated Audit Program (DOECAP).

7.9.1 Contained-In/Contaminated-With Determinations

The Northeast Plume groundwater is contaminated with certain VOCs that originated from disposal of spent solvents. As a result, the TCE contamination in the Northeast Plume has been declared a RCRA listed hazardous waste (code F001, F002, U228). Additionally, 1,1,1-trichloroethane (1,1,1-TCA), also a RCRA hazardous waste constituent associated with F001 and F002, has been detected at low levels in the Northeast Plume. Under the EPA "contained-in" policy, environmental media, such as groundwater, must be managed as hazardous waste if they "contain" listed hazardous waste. EPA guidance, *Management of Remediation Waste under RCRA*, recommends that "contained-in" determinations use conservative, health-based standards to develop site-specific health-based levels of hazardous constituents below which contaminated environmental media would be considered to no longer contain hazardous waste (EPA 1998). Consequently, per the EPA's contained-in policy, the Northeast Plume groundwater is considered to contain the RCRA listed hazardous waste. Management of such groundwater must comply with the RCRA ARARs for hazardous waste identified in the original ROD (DOE 1995) and the ESD (DOE 2016), unless the groundwater is determined to contain TCE below the health-based level. The site-specific health-based level for TCE in groundwater at PGDP has been established at 30 ppb, which is based on Kentucky ambient water quality criteria for protection of human health for consumption of fish [401 KAR 10:031 § 6(1)]. Groundwater contaminated with TCE generated from the Northeast Plume project at or below 30 ppb will be considered to no longer contain the RCRA listed hazardous waste (F001, F002, U228). Groundwater that meets the health-based level for TCE also shall be deemed to no longer contain 1,1,1-TCA. Degradation products (*cis*-1,2-DCE; *trans*-1,2-DCE; or vinyl chloride) associated with TCE may be present in groundwater, and any treatment process used for the TCE-contaminated groundwater also would be effective in treating/reducing the concentrations of the degradation products.

Most of the contaminated groundwater extracted for treatment exceeds this site-specific health-based level; thus, it must be managed as RCRA listed hazardous waste. Consequently, certain solid wastes generated from treatment units that treat groundwater containing TCE above 30 ppb are considered RCRA hazardous waste due to the derived-from rule at 40 *CFR* § 261.3(c) and (d) (401 *KAR* 31:010 § 3). The treated groundwater that is discharged into the receiving surface water body (e.g., Little Bayou Creek) through the CERCLA outfall(s) will comply with identified Clean Water Act and Kentucky water quality standards identified as ARARs and will be below the 30 ppb TCE. Pursuant to 40 *CFR* § 261.4(a)(2) (401 *KAR* 31:010 § 4), point source discharges are excluded from regulation as a hazardous wastes. The exclusion applies only to the actual point source discharge and does not exclude industrial wastewaters while they are collected, stored, treated before the discharge, nor does it exclude sludge that is generated by industrial wastewater treatment.

Some of the waste debris, other than PPE, and environmental media such as drill cuttings generated during this project will be characterized and the results compared to health-based standards to determine whether or not any concentrations of TCE and 1,1,1-trichloroethane (TCA) are above health-based levels listed in Table 7. If the concentrations are below the levels contained in Table 7, then the waste will be deemed not to contain or not to be contaminated with a (RCRA) listed waste (based on TCE/TCA content) for the purposes of management at the site.

Table 7. Health-Based Levels for TCE and 1,1,1-TCA

Constituent	Concentration in solids (ppm)
TCE	39.2
1,1,1-TCA	2,080

Because data from previous sampling events indicate that conditions for C-746-U Landfill disposal potentially will be met, characterization for C-746-U Landfill disposal will be undertaken. Land disposal restrictions (LDRs) generally apply to media and debris generated from this project that no longer contain or no longer are contaminated with RCRA hazardous waste. The LDR treatment standard for TCE is 6 mg/kg, which is more restrictive than the PGDP contained-in level of 39.2 mg/kg; therefore, the LDR treatment standard also must be satisfied in addition to the contained-in determination in order to place the material in a landfill.

Health-based standards of 39.2 ppm TCE and 2,080 ppm 1,1,1-TCA in solids will be used as the criteria for making contained-in/contaminated-with determinations for environmental media and debris designated for disposal at the C-746-U Landfill. Solid waste disposal at landfills other than C-746-U will be subject to a contained-in/contaminated-with determination that will be approved by the Commonwealth of Kentucky and the state in which the receiving landfill is located. The Kentucky Energy and Environment Cabinet (KEEC) has agreed to consult with DOE and the state where the off-site facility is located to reach agreement upon the appropriate health based standard for making such determinations for waste that is be shipped to such a facility.

Aqueous liquids (groundwater, well purge and development water, and sample residuals water) contaminated with TCE will be treated to the wastewater effluent limit of 0.030 mg/L or less in an on-site permitted wastewater treatment facility. Treated effluent meeting the discharge limit of 0.030 mg/L also shall be below the health-based level and considered to “no longer contain” listed hazardous water (i.e., TCE). Based on the process knowledge of the C-612 treatment facility’s performance in achieving effluent levels for TCE that are significantly below health-based levels, this treated wastewater may be directly discharged to KPDES Outfall 001 or to on-site ditches that flow to KPDES Outfall 001 without providing KEEC supporting analytical data or contained-in/contaminated-with determinations.

Soil and debris wastes shall be sampled and analyzed in accordance with Section 7.9.2. For soil and debris waste meeting the health-based standards above, DOE shall submit its contained-in determinations and supporting analytical data to the KEEC. The KEEC will review DOE’s determination and supporting analytical data and provide DOE with notification of any concerns the Cabinet has within 30 days. After 30 days, if the Cabinet has not notified DOE of any concerns, DOE may dispose of soil and debris waste at the C-746-U Landfill if it meets WAC. Soil and debris wastes from this project not meeting the WAC for the C-746-U Landfill will be shipped off-site for disposal at an appropriate facility meeting the necessary regulatory criteria.

7.9.2 Waste Characterization

Waste characterization sampling will be performed in accordance with procedure CP3-WM-0437, *Waste Characterization and Profiling*. Based on sample analyses, existing data, or process knowledge, the waste may be classified into one of the following categories:

- RCRA-listed hazardous waste
- RCRA characteristic hazardous waste
- Polychlorinated biphenyl (PCB) waste
- Transuranic waste (TRU)
- Low-level waste (LLW)
- Mixed waste or
- Nonhazardous solid waste

Tables 8, 9, 10, and 11 list the analytical testing methods that will be used for analysis.

Table 8. TCLP Parameters for Analysis of Solid Waste

Constituent	Method	TCLP Regulatory Limit (mg/L)	20 Times TCLP Regulatory Limit (mg/kg)
1,1-Dichloroethene	8260	0.7	14
1,2-Dichloroethane	8260	0.5	10
Arsenic	6010/6020	5.0	100
Barium	6010/6020	100.0	2,000
Benzene	8260	0.5	10
Cadmium	6010/6020	1.0	20
Carbon tetrachloride	8260	0.5	10
Chlordane	8081	0.03	0.6
Chlorobenzene	8260	100.0	2,000
Chloroform	8260	6.0	120
Chromium	6010/6020	5.0	100
Lead	6010/6020	5.0	100
Mercury	7470	0.2	4
Methylethylketone	8260	200.0	4,000
Selenium	6010/6020	1.0	20
Silver	6010/6020	5.0	100
Tetrachloroethene	8260	0.7	14
Trichloroethene	8260	0.5	10
Vinyl chloride	8260	0.2	4

Table 9. Analytical Parameters for Radiological and PCB Characterization

Constituent	Method
Total uranium	Mass Spec
Neptunium-237	Alpha Spec
Plutonium-239/240	Alpha Spec
Plutonium-238	Alpha Spec
Thorium-230/232	Alpha Spec
Technetium-99	Liquid Scintillation
Cesium-137	Gamma Spec
PCB	8082

Table 10. Waste Characterization Requirements for Solid Waste

Constituent	Method
TCLP VOCs	SW-846 1311, 8260
TCLP metals	SW-846 1311, 6010/6020/7470
Acetone	8260
Toluene	8260

Table 11. Waste Characterization Requirements for Decontamination, Development, and Purge Water

Parameter	Method	Detection Limit
TCE	EPA 624	0.001 mg/L
1,1,1-TCA	EPA 624	0.001 mg/L
PCBs	EPA 608	varies by Aroclor
Total recoverable metals*	EPA 200.8/245.2	varies by metal
Total suspended solids	EPA 160.2	30 mg/L

*Total recoverable metals: antimony, arsenic, beryllium, cadmium, chromium, copper, iron, lead, nickel, calcium, silver, tantalum, uranium, zinc, and mercury.

Wastes generated from sites designated as potentially contaminated will be characterized to classify the waste for proper handling, record keeping, transfer, storage, and disposal. Waste analyses will be performed using the EPA approved procedures, as applicable. Analyses required for hazardous waste classification will reference EPA SW-846 or other EPA-approved methods, as required. Wastewater analyses will reference the applicable analytical requirements in the PGDP KPDES permit, the Clean Water Act, or Safe Drinking Water Act. QA/QC requirements and data management requirements will be followed for waste characterization sampling activities. Characterization requirements and guidance are provided in the site WAC and CP3-WM-0437, *Waste Characterization and Profiling*. The WMC will coordinate with the DOE contractor project manager and DOE contractor sample and data management group for required analyses and guidance on collection and transfer of characterization samples to a Sample Management Office-approved fixed-base laboratory that has been audited under DOECAP.

7.9.2.1 RCRA-listed hazardous waste

Based on process knowledge and existing historical sample data, the generation of RCRA-listed hazardous waste is expected on this project. The waste is listed-hazardous due to the presence of TCE in the RGA underlying the majority of the area in which the soil borings, EWs and monitoring wells are to be installed. Waste generated during soil borings (i.e., drilling cuttings, purge water, sample residuals) will be classified as RCRA-listed hazardous wastes with waste codes F001, F002, and U228 if the boring locations are inside the PGDP industrial facility or from the RGA and if analytical results for the associated soil samples and water samples are above the health-based levels discussed in Table 7. If the

concentrations are below the levels contained in Table 7, then the waste will be deemed not to contain or not to be contaminated-with a RCRA listed waste (based on TCE/TCA content) for the purposes of on-site management. If the WAC is met, the waste will be properly disposed of in the C-746-U Landfill.

Aqueous liquids that have undergone wastewater treatment and meet the KPDES discharge limits shall be considered to “no longer contain” listed hazardous waste (i.e., TCE). This treated wastewater may be discharged directly to permitted KPDES Outfall 001 or on-site ditches that flow to permitted KPDES Outfall 001 or to C-765 Northeast Plume treatment system and associated CERCLA outfall.

7.9.2.2 RCRA-characteristic hazardous waste

Based on process knowledge and existing historical sample data, the generation of RCRA characteristic-hazardous waste is possible during this action. Any waste determined to be RCRA characteristic-hazardous waste will be treated in the same manner as RCRA listed-hazardous waste for handling, storage, and disposal requirements.

7.9.2.3 PCB wastes

Based on process knowledge and existing historical sample data, the generation of PCB-contaminated waste is not expected to be generated on this project.

7.9.2.4 TRU wastes

TRU wastes are those that are contaminated with elements that have an atomic number greater than 92, including neptunium, plutonium, americium, and curium that are in concentrations greater than 100 nCi/g. Although it is possible that TRU elements may be detected in characterization samples collected on this project, it is unlikely that any of the waste generated will be at or above the TRU threshold limit. If TRU waste is generated in performing the optimization work, the waste will be managed as specified in DOE Orders 435.1, 458.1 and 40 *CFR* Part 191.

7.9.2.5 Low-level waste

LLWs are described as any nonhazardous, non-PCB, or non-TRU waste containing radioactivity or other radionuclides in a concentration greater than authorized limits or the latest off-site release criteria and are not classified as high-level waste, TRU waste, spent nuclear fuel, or by-product material. LLW may be generated from materials removed from the radiological areas. All wastes from this project have the potential to be classified as LLW. The potential radiological contaminant of concern is Tc-99. Due to varying levels of Tc-99, some work may be performed under a radiological work permit (RWP).

7.9.2.6 Mixed wastes

Mixed waste contains both hazardous waste and source, special nuclear, or byproduct material subject to the Atomic Energy Act of 1954. The generation of mixed waste is possible on this project.

7.9.2.7 Nonhazardous wastes

Waste that does not meet the classification requirements of RCRA hazardous wastes, PCB wastes, LLW, TRU waste, or mixed wastes will be classified as nonhazardous solid waste. Nonhazardous waste will be generated as part of this project. The types of materials expected to be nonhazardous wastes are construction debris, waste concrete, grout, shipping materials, and containers (e.g., boxes, bags).

7.10 SAMPLING AND ANALYSIS OF WASTE

The WMC will be responsible for coordinating the sampling of solid and liquid waste in accordance with this section. During sampling, all appropriate health and safety concerns will be addressed in accordance with Section 5. All samples will be screened for radioactivity based on the RWP and appropriate actions taken to prevent the spread of contamination. Sample materials from different containers will not be mixed unless they are from the same waste stream, and only containers requiring further characterization will be sampled. Samples will be assigned a unique identifier. The following text summarizes the waste characterization requirements and describes the sampling procedures.

7.10.1 Solid Waste

For solid wastes, the “20 times” rule will be used to determine if the waste is characteristically hazardous. That is, if the total concentrations of RCRA constituents are less than 20 times Toxicity Characteristic Leaching Procedure (TCLP) limits in 40 *CFR* § 261.24, then the waste will be considered not to be characteristically hazardous. Where the total concentrations of RCRA constituents are greater than 20 times the TCLP limits, TCLP analyses will be performed to confirm the result.

For listed waste determinations for media or debris, the total concentrations of TCE and 1,1,1-TCA will be compared to the approved health-based levels of 39.2 ppm for TCE and 2,080 ppm for 1,1,1-TCA. If total concentrations are detected, but less than 39.2 ppm TCE and 2,080 ppm 1,1,1-TCA, the waste will be determined to “no longer contain” listed constituents. (The detection limit for TCE and 1,1,1-TCA is 5 ppb.) If the results exceed the health-based levels, the waste will be considered a RCRA-listed hazardous waste and must be managed and disposed of as such.

Solid waste may be containerized in drums, ST-90 boxes, intermodals, or 25-yd³ roll-off containers during generation. Specific sampling event plans (including parameters, required detection limits, and QC requirements) will be identified when the proposed final waste containers have been presented to the waste characterization organization. Physical sampling will be performed in accordance with approved standard operating procedures.

Additional analyses to meet off-site disposal WAC also may be required and will be specified upon selection of the disposal site.

7.10.2 Aqueous Liquids

Liquid waste generated during drilling, well development, and decontamination activities will be characterized using process knowledge and/or sampling data as appropriate. These liquid wastes will be managed in accordance with ARARs prior to being processed through particulate filters at the drill site or accumulated and stored on-site until they can be processed at C-752-C for separation of groundwater and soils, as necessary. If filtered, the filtered water will be pumped to dual-wall holding tanks until it is verified that the filtered water meets the appropriate acceptance criteria for suspended solids and then is transferred to the on-site C-612 Northwest Plume Groundwater System. Potential contaminants of concern in this filtered waste water will be assumed to be consistent with those in the Northeast Plume groundwater currently treated by a TU. No additional sampling and analysis is planned prior to treatment by the C-612 Northwest Plume Groundwater System.

Groundwater generated during drilling, well development, and decontamination activities that has undergone wastewater treatment, and meets the KPDES discharge limits shall be considered to “no longer contain” listed hazardous waste. This treated wastewater may be discharged directly to permitted KPDES

Outfall 001 or on-site ditches that flow to permitted KPDES Outfall 001 or an authorized CERCLA outfall, as appropriate.

Debris (e.g., particulate filters) and media (e.g., soils) separated from the groundwater will be managed as outlined in Section 7.10.1. Any carbon media or other wastewater treatment sludge will be managed based upon the process knowledge and/or analytical data for the influent waste stream in accordance with ARARs.

8. QUALITY ASSURANCE AND CONSTRUCTION QUALITY CONTROL PLAN

Environmental media sampling will be conducted under a project-specific Quality Assurance Project Plan (QAPP) for this optimization effort. Refer to Appendix D of this RAWP for the project-specific QAPP. The remaining general optimization efforts are aligned with construction activities; the following construction quality control plan (CQCP) will be used for ensuring a quality implementation.

8.1 INTRODUCTION

The CQCP which is presented in the following subsections provides a means to maintain effective quality control (QC) of the construction activities associated with the optimization of the IRA. The quality control measures as presented herein include quality control organization; methods of performing, documenting, and enforcing QC operations of both the primary contractor and its subcontractors (including inspection and testing); inspections to be performed; and protocol describing corrective actions.

Overall management of the CQCP will be the responsibility of the DOE prime contractor project manager. The project manager will have the authority to act in all construction quality control matters and will be responsible for ensuring that all materials and work comply with the contract specifications. All inspection and testing will be at the disposal of the project manager and his/her representatives to ensure that all aspects of work are compliant with the work control and design documentation. The project manager will report any deviations from the CQCP independently to the manager or projects.

8.2 SITE DESCRIPTION

The background of the Northeast Plume IRA optimization project is contained in Section 1.

8.3 PROJECT ORGANIZATION

The prime contractor's key personnel assigned to this project will possess a broad range of remedial action experience and skills and PGDP site knowledge. All will have had experience dealing with the handling of contaminated waste and should be familiar with requirements of day-to-day work at PGDP.

The project organization for this optimization project, along with project roles and responsibilities, is provided in Section 3, Project Organization.

8.4 QUALITY ASSURANCE METHODS

This CQCP will be implemented in order to ensure compliance with the specifications for remedial action construction as detailed in specifications and drawings located in other applicable section of this RAWP. The basis of the CQCP is nationally recognized codes and standards included in the certified for construction package and procedures as followed by the DOE prime contractor as discussed in Section 2.

QA measures will extend to staffing; types of construction materials and construction equipment to be used; and methods of performing, documenting, and enforcing quality operations of the DOE prime contractor and subcontractors (including inspection and testing).

8.4.1 Implementation

As previously stated, maintenance of the CQCP will be the responsibility of the project manager. The project manager or assigned representatives will be responsible for ensuring that all materials and work comply with the governing documents, specifications and drawings. The project manager will have the field superintendent, QA manager, and the field technical staff available to assist in performing on-site inspections and testing of the materials and equipment used in implementing the optimization of the IRA. The field superintendent or the project manager designee will report directly to the project manager and will complete site inspections to ensure compliance with the QC specifications. The field superintendent also may delegate the responsibility of performing and inspection on an as-needed basis.

8.4.2 Documenting

The inspection reports will be completed listing all field testing and material sampling activities. The reports will be submitted to the project manager. The project manager or designee will be responsible for resolving issues identified in the quality inspection and testing reports and for ensuring that all materials and work comply with the work control, specification and drawings, and that all performance standards are met. The field superintendent will record project activities in a daily log for the optimization project that will be maintained on-site at all times. All site activities, site inspections, and field testing of materials will be recorded in the log, along with any unacceptable site occurrences or deficiencies and their associated corrective actions. Each entry into the log will be signed by the field superintendent.

8.5 INSPECTIONS

To ensure that all construction and remedial activities comply with the project specifications, the project manager or designee will complete, in conjunction with the Field Technical Staff, three phases of site inspections for each feature of work. The following are the types of inspections to be used.

Phase I—Preparatory Inspection

Preparatory inspections will be performed prior to beginning work on any definable feature of the project and will include these:

- Review submittal requirements for the performance of the work;
- Check to assure that provisions have been made to provide required field QC testing;
- Examine the work area to ascertain that all preliminary work has been completed;

- Verify all field dimensions and advise project manager of any discrepancies;
- Perform a physical examination of materials and equipment to assure that they conform to approved drawings, specification, or approved submittal data.

Phase II—Initial Inspections

Initial phase inspections will be performed as soon as a representative portion of the particular feature of the optimization work has been accomplished. Initial inspections include, but are not limited to, examination of the quality of workmanship; review of control testing for compliance with control requirements; and identification of defective or damaged materials, omissions, and dimensional requirements.

Phase III—Follow-Up Inspections

Follow-up inspections will be performed daily as work progresses to ensure continuing compliance with construction requirements, including control testing, until completion of the particular feature of work. The follow-up inspections also will evaluate the repair or corrective measures taken to correct previously identified issues. Final follow-up inspections will be conducted and deficiencies corrected prior to beginning new work.

8.6 FIELD TESTING PROCEDURES

The contractor will conduct field-testing to verify that control measures are adequate to provide a product that conforms to the construction requirements.

Field testing will be conducted under the auspices of the field superintendent or designee who will complete the following tasks:

- Arrange for or conduct field testing in accordance with applicable test codes and standards parameters (American Society for Testing and Materials, etc.).
- Verify that facilities and testing equipment are available and comply with testing standards and ensure that testing facilities are Fluor Federal Services, Inc., Paducah Deactivation Project-approved suppliers or part of the Sample Management Office Contract Laboratory Program.
- Check test equipment calibration data against certified standards.
- Verify that all tests are documented and submitted as part of QC system reporting.
- Review all test documentation prior to submittal.

8.7 SUBMITTALS

The subcontractors responsible for providing the materials, equipment, and performing the construction will follow standard procedures concerning submittals. Each submittal form may contain more than one submittal specific to that specification section. A submittal register listing major submittals will be prepared by the field superintendent or designee from the field technical staff. The field superintendent will be responsible for the review and approval of submittals prior to the use of the subject materials or

equipment. This includes reviews of materials and suppliers' catalog cuts, and subcontractor submittals. The field superintendent or designee will review the submittal for completeness and compliance with the construction specifications.

8.8 DOCUMENTATION

All testing results will be recorded in the field superintendent's daily log. Any concerns or deviations from the required material specifications and the actions taken to correct the problems will be noted in the log and will be reported back to the appropriate subcontractor. Information recorded from the testing and reported back to the subcontractor by the field superintendent or designee may include any of the following:

- Definable features of work that was addressed
- Description of trades working on the project
- Numbers of personnel
- Weather conditions
- Construction requirements reference numbers and sections
- Types and numbers of tests performed
- Results of testing
- Nature of defects or cause for rejection
- Suggested corrective action(s)

8.9 REVISIONS TO WORK

Revisions/corrections/repairs resulting from the inspections and testing under this CQCP for work associated with implementing this optimization to the Northeast Plume IRA may require corrective actions to be implemented by subcontractor or the DOE prime contractor. The DOE prime contractor may be required to revise the construction specifications to allow subcontractor work to be completed. The subcontractor shall submit a corrective action plan. The plan should contain information similar to the following:

- Deficiency identified
- Corrective action to be taken and date
- Schedule delays encountered
- Information and/or directions received from the DOE prime contractor staff
- Health and safety issues or deficiencies and how they were resolved
- Expected cost impacts

The DOE prime contractor project manager will be responsible for ensuring total compliance of fieldwork to the project specifications. Should modifications or revisions to the specifications become necessary, the DOE prime contractor will make the request, in writing, to the subcontractor contract representative.

8.10 DEFINABLE FEATURES OF WORK

Listed below are the general categories and types of work that will be performed as part of this optimization project. These items, known as Definable Features of Work, have been grouped into the various categories in which work will be performed. Suitable QC methods and procedures will be used in

order to ensure that all work is performed to the standards and quality required by the construction specifications. The following are the definable features of work that will be performed under this contract:

- Preconstruction preparation activities
- Mobilization
- Site preparation
- Drilling
- EW and monitoring well installation
- Electrical service construction
- Pipeline construction
- Mechanical system construction and piping
- Electrical system wiring
- Programmable logic controller programming
- Demobilization

9. DATA MANAGEMENT AND IMPLEMENTATION PLAN

The Northeast Plume IRA optimization project will incorporate by reference the data management and implementation plan (DMIP) requirements from the Southwest Plume RAWP. The Southwest Plume RAWP DMIP, Sections 10.2 through 10.8 (<http://paducaheic.com/Search.aspx?accession=ENV 1.A-00588>), will be implemented as written for scope elements associated with the Northeast Plume IRA optimization project. References to the Southwest Plume project should be replaced with Northeast Plume IRA optimization project.

10. REFERENCES

- COE (U.S. Army Corps of Engineers) 2007. *Review Report: Groundwater Remedial System Performance Optimization at PGDP, Paducah, Kentucky*, U.S. Army Corps of Engineers, Nashville, TN, May.
- DOE (U.S. Department of Energy) 1995. *Record of Decision for Interim Remedial Action of the Northeast Plume at the Paducah Gaseous Diffusion Plant, Paducah, Kentucky*, DOE/OR/06-1356&D2, U.S. Department of Energy, Paducah, KY, June.
- DOE 2003. *Five-Year Review for Remedial Actions at the Paducah Gaseous Diffusion Plant, Paducah, Kentucky*, DOE/OR/07-2067&D2, U.S. Department of Energy, Paducah, KY, October.
- DOE 2007. *Review Report: Groundwater Remedial System Performance Optimization at PGDP, Paducah, Kentucky*, prepared for Office of Groundwater and Soil Remediation and Office of Engineering and Technology, U.S. Department of Energy, Paducah, KY, May 24.
- DOE 2008a. *2008 Update of the Paducah Gaseous Diffusion Plant Sitewide Groundwater Flow Model*, PRS-ENR-0028, U.S. Department of Energy, Paducah, KY, February.

- DOE 2008b. *Remedial Action Work Plan for the Interim Remedial Action for the Volatile Organic Compound Contamination at the C-400 Cleaning Building at the Paducah Gaseous Diffusion Plant, Paducah, Kentucky*, DOE/LX/07-0004&D2/R1, U.S. Department of Energy, Paducah, KY, May.
- DOE 2009. *Five-Year Review for Remedial Action at the Paducah Gaseous Diffusion Plant, Paducah, Kentucky*, DOE/LX/07-0117&D2, U.S. Department of Energy, Paducah, KY, May.
- DOE 2012. *Site Management Plan, Paducah Gaseous Diffusion Plant, Paducah, Kentucky, Annual Revision—FY 2012*, DOE/LX/07-1264&D2, U.S. Department of Energy, Paducah, KY, February.
- DOE 2013. *Explanation of Significant Differences to the Record of Decision for the Interim Remedial Action of the Northeast Plume at the Paducah Gaseous Diffusion Plant, Paducah, Kentucky*, DOE/LX/07-1291&D2, U.S. Department of Energy, Paducah, KY, August.
- DOE 2013a. *Remedial Action Work Plan for In Situ Source Treatment by Deep Soil Mixing of the Southwest Groundwater Plume Volatile Organic source at the C-747-C Oil Landfarm (Solid Waste Management Unit 1) at Paducah Gaseous Diffusion Plant, Paducah, Kentucky*, December.
- DOE 2014. *Five-Year Review for Remedial Action at the Paducah Gaseous Diffusion Plant, Paducah, Kentucky*, DOE/LX/07-1289&D2/R1, Secondary Document, U.S. Department of Energy, Paducah, Kentucky, May.
- DOE 2015a. *Memorandum of Agreement for Resolution of Formal Dispute of the Explanation of Significant Differences to the Record of Decision for the Interim Remedial Action of the Northeast Plume at the Paducah Gaseous Diffusion Plant, Paducah, Kentucky (DOE/LX/07-1291&D2), and Remedial Action Work Plan for Optimization of the Northeast Plume Interim Remedial Action at the Paducah Gaseous Diffusion Plant, Paducah, Kentucky (DOE/LX/07-1280&D2)*, U.S. Department of Energy, Paducah, KY, July 31.
- DOE 2016. *Explanation of Significant Differences to the Record of Decision for the Interim Remedial Action of the Northeast Plume at the Paducah Gaseous Diffusion Plant, Paducah, Kentucky*, DOE/LX/07-1291&D2/R2, U.S. Department of Energy, Paducah, KY, January 13.
- EPA (U.S. Environmental Protection Agency) 1998. *Federal Facility Agreement for the Paducah Gaseous Diffusion Plant*, U.S. Environmental Protection Agency, Atlanta, GA, February 13.
- EPA 2003. Smith, W.A., Director, Waste Management Division, U.S. Environmental Protection Agency, Atlanta, GA, letter to W. E. Murphie, Manager, Portsmouth/Paducah Project Office, U.S. Department of Energy, Paducah, KY, and G. E. VanSickle, Paducah Manager of Projects, Bechtel Jacobs Company LLC, Kevil, KY, Approval of the “Five-Year Review for the Paducah Gaseous Diffusion Plant, Paducah, Kentucky (DOE/OR/07-2067&D2),” December 30.
- EPA 2009. Hill, F. E., Director, Superfund Division, Sam Nunn Federal Center, Atlanta, GA, letter to W. Murphie, Director Portsmouth/Paducah Project Office, U.S. Department of Energy, Paducah Site Office, Paducah, KY, “Approval of the 2008 CERCLA Five-Year Review for the Paducah Gaseous Diffusion Plant (DOE/LX/07-0117&D2),” June 4.

- Harbaugh, A., E. Banta, C. Hill, and M. McDonald 2000. *MODFLOW-2000, The U.S. Geological Survey Modular Ground-Water Model-Users Guide to Modularization Concepts and Groundwater Flow Process.*
- Hill 2009. Hill, F. E. June 4, 2009. U.S. Environmental Protection Agency, Atlanta, GA, letter to W. Murphie, U.S. Department of Energy, Paducah, KY, "Re: Approval of the 2008 CERCLA Five-Year Review for the Paducah Gaseous Diffusion Plant (DOE/LX/07-0117&D2)."
- ITRC (Interstate Technology & Regulatory Council) 2004. *Remediation Process Optimization: Identifying Opportunities for Enhanced and More Efficient Site Remediation*, RPO-1, Remediation Process Optimization Team, ITRC, Washington, DC; available on the Internet at <http://www.itrcweb.org>.
- KDEP (Kentucky Department for Environmental Protection) 2003. M. V. Welch, P.E., Manager Hazardous Waste Branch, Kentucky Natural Resources and Environmental Protection Cabinet, Kentucky Department for Environmental Protection, Frankfort, KY, to W. E. Murphie, Manager, Portsmouth/Paducah Project Office, U.S. Department of Energy, Paducah, KY, and G. L. Dover, Plant Manager, Bechtel Jacobs Company LLC, Kevil, KY, Approval of the "Five-Year Review for the Paducah Gaseous Diffusion Plant, Paducah, Kentucky (DOE/OR/07-2067&D2), McCracken County, Kentucky, KY8-890-008-982," November 14.
- KEEC (Kentucky Energy and Environment Cabinet) 2009. April J. Webb, P.E., Manager, Hazardous Waste Branch, Kentucky Energy and Environment Cabinet, Frankfort, KY, letter to Reinhard Knerr, Paducah Site Lead, Portsmouth/Paducah Project Office, U.S. Department of Energy, Paducah, KY, Approval of the "Five-Year Review for Remedial Actions at the Paducah Gaseous Diffusion Plant (DOE/LX/07-0117&D2)," March 30.
- Knerr 2011. Knerr R. May 16, 2011. U.S. Department of Energy, Kevil, KY, letter to T. Ballard, U.S. Environmental Protection Agency, Atlanta, GA, and E. Winner, Kentucky Department for Environmental Protection, Frankfort, KY, "Milestone Modification for the Groundwater Operable Unit Dissolved-Phase Plumes D1 Remedial Investigation/Feasibility Study Work Plan," PPO-02-1 196393-11A.
- Pollack, D. W. 1994. User's Guide for MODPATH/MODPATH-PLOT, Version 3: A particle tracking post-processing package for MODFLOW, the U.S. Geological survey finite-difference ground-water flow model. U.S. Geological Survey Open-File Report 94-464.
- Winner 2009. Winner E. March 30, 2009. Kentucky Department for Environmental Protection, Division of Waste Management, Frankfort, KY, letter to R. Knerr, U.S. Department of Energy, Paducah, KY, "Re: Five-Year Review for Remedial Actions at the Paducah Gaseous Diffusion Plant (DOE/LX/07-0117&D2), Paducah, McCracken County, Kentucky, KY8-890-008-982."

APPENDIX A
CONSTRUCTION FIGURES

THIS PAGE INTENTIONALLY LEFT BLANK

NOTES:

- IT IS THE RESPONSIBILITY OF THE SUBCONTRACTOR TO ENSURE THEIR DRILLING EQUIPMENT IS ADEQUATELY SUPPORTED WHILE ACCESSING AND INSTALLING WELLS. ANY TEMPORARY ACCESS ROADS OR PADS CONSTRUCTED THE SUBCONTRACTOR SHALL MEET THE REQUIREMENTS OF SPECIFICATION SECTION 01 55 13 TEMPORARY ACCESS ROADS AND PADS. THE SUBCONTRACTOR IS RESPONSIBLE FOR ALL COST ASSOCIATED WITH THE RECOVERY OF STUCK EQUIPMENT, INCLUDING ANY CONTRACTOR INCURRED COSTS.
- GRAVEL ACCESS ROADS TO WELL SITES SHALL BE ROUTED GENERALLY AS SHOWN. FIELD ADJUST AS REQUIRED WITH CONCURRENCE OF CONTRACTOR. DOCUMENT CHANGES ON "RED-LINE" SET OF DRAWINGS.
- CLEAR AREAS TO RECEIVE GRAVEL ACCESS ROADS IN ACCORDANCE WITH SPECIFICATION SECTION 31 10 00 SITE CLEARING. MOW/BUSH HOG AREAS GRASS AREAS TO RECEIVE GRAVEL ROADS AS REQUIRED.
- GRAVEL ACCESS ROADS SHALL BE CONSTRUCTED AS FOLLOWS:
 - GEOTEXTILE FABRIC IN ACCORDANCE WITH SPECIFICATION SECTION 31 05 19, GEOSYNTHETICS FOR EARTHWORK.
 - MIN. 6 INCHES THICK, COMPACTED DGA IN ACCORDANCE WITH SPECIFICATION SECTION 32 11 24, DENSE GRADE AGGREGATE (DGA) AND CRUSHED STONE BASE (CSB).
 - MIN. 12 FEET WIDE; MAX. 14 FEET WIDE
- CULVERTS SHALL BE 16 GAGE (MIN.) ALUMINIZED TYPE 2, CORRUGATED (1/2") STEEL PIPE LAID DIRECTLY ON GRADE IN EXISTING DRAINAGE FLOW LINES AS SHOWN IN PLAN. NO EXCAVATION IS REQUIRED. BUILD UP ROAD MATERIAL AS NECESSARY TO PROVIDE A SMOOTH TRANSITION OVER NEW CULVERT.

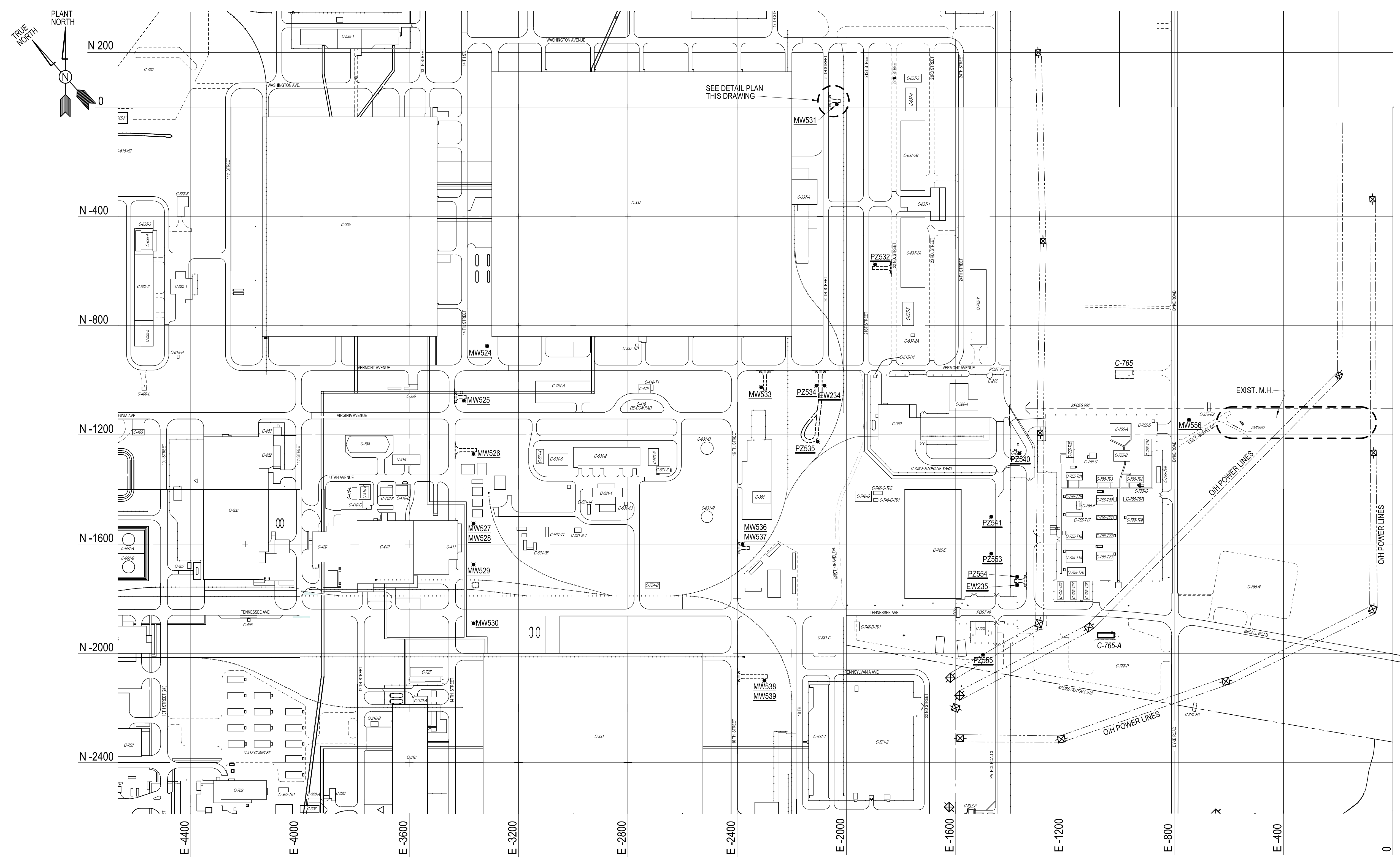

MONITORING WELL LOCATION PLAN

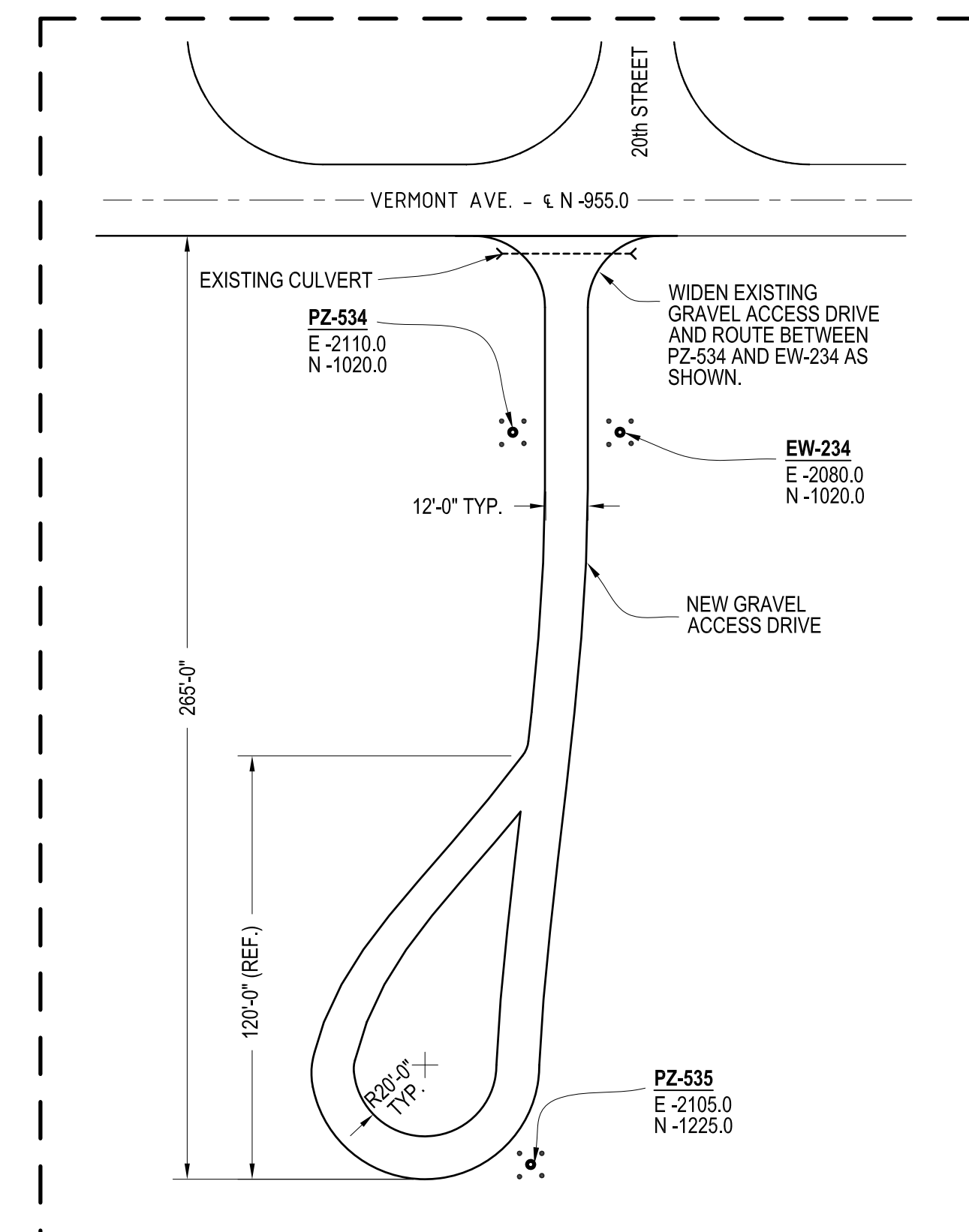
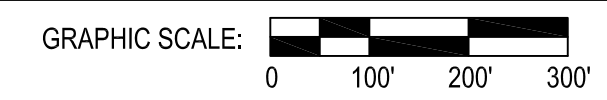

PZ534/535 & EW234 ACCESS ROAD DETAIL



WELL COORDINATE TABLE

WELL NUMBER	EASTING (X)	NORTHING (Y)
EW234	-2080.0	-1020.0
EW235	-1375.0	-1750.0
MW524	-3315	-875
MW525	-3400	-1075
MW526	-3365	-1270
MW527/MW528	-3365	-1525
MW529	-3365	-1675
MW530	-3365	-1890
MW531	-2035	+10
PZ532	-1895	-576
MW533	-2312	-1026
PZ534	-2110	-1020
PZ535	-2105	-1225
MW536/MW537	-2380	-1600
MW538/MW539	-2300	-2100
PZ540	-1366	-1268
PZ541	-1470	-1500
PZ553	-1470	-1635
PZ554	-1375	-1720
PZ555	-1500	-2005
MW556	-746	-1145

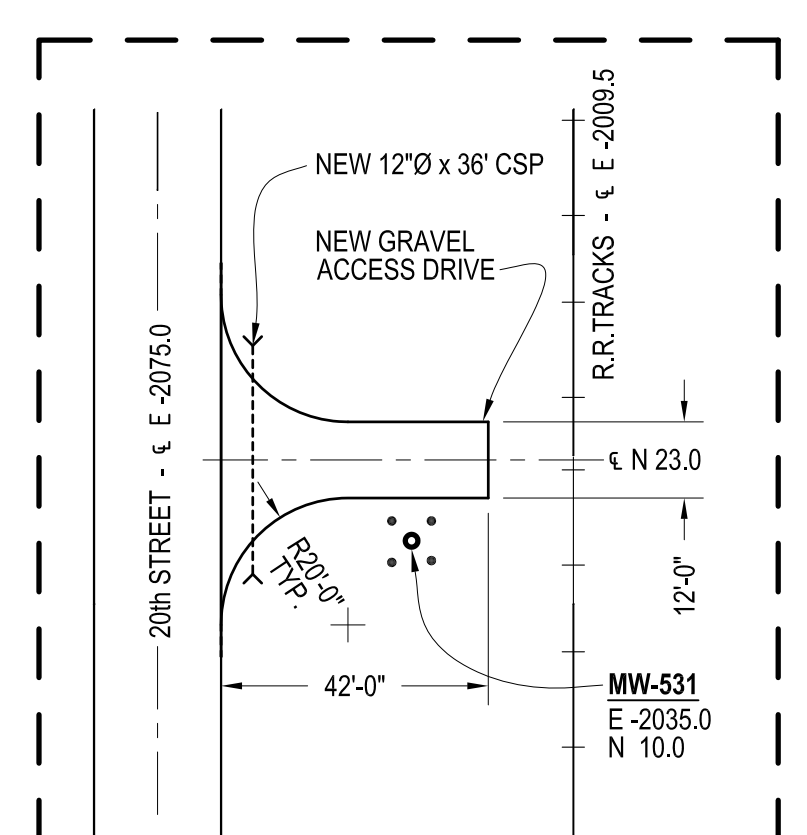

MW531 ACCESS ROAD DETAIL

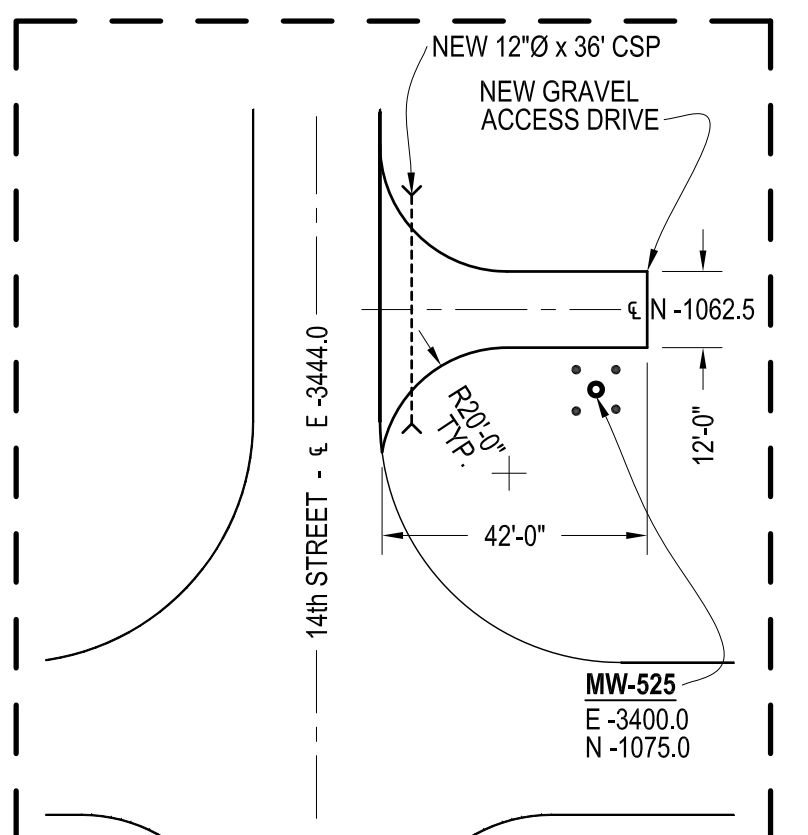
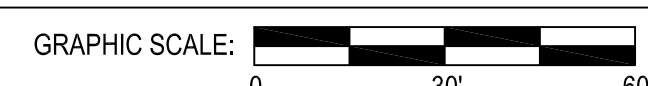

MW525 ACCESS ROAD DETAIL

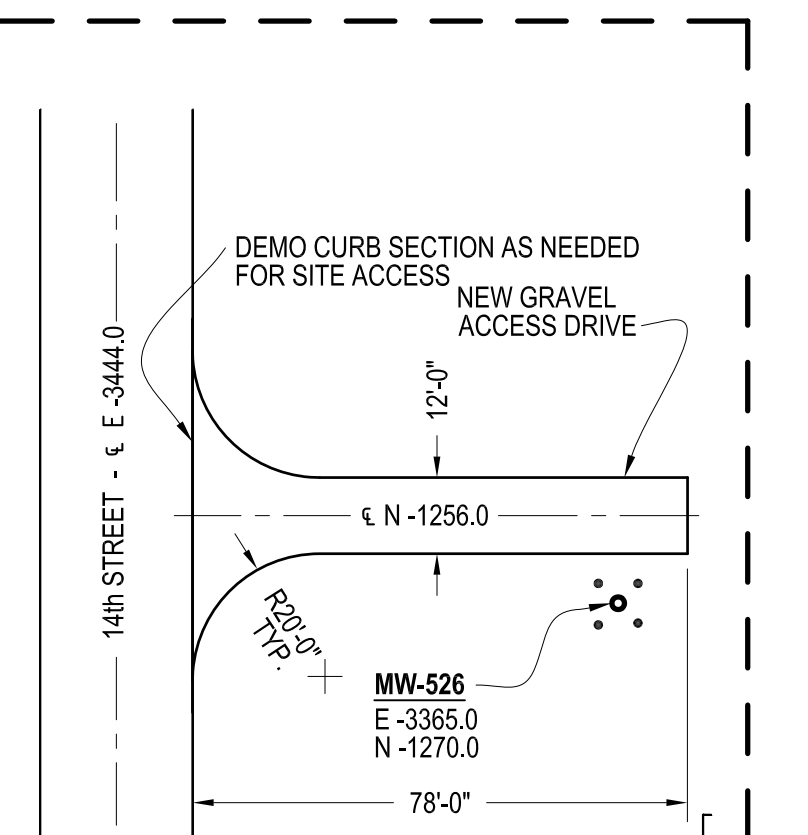

MW526 ACCESS ROAD DETAIL

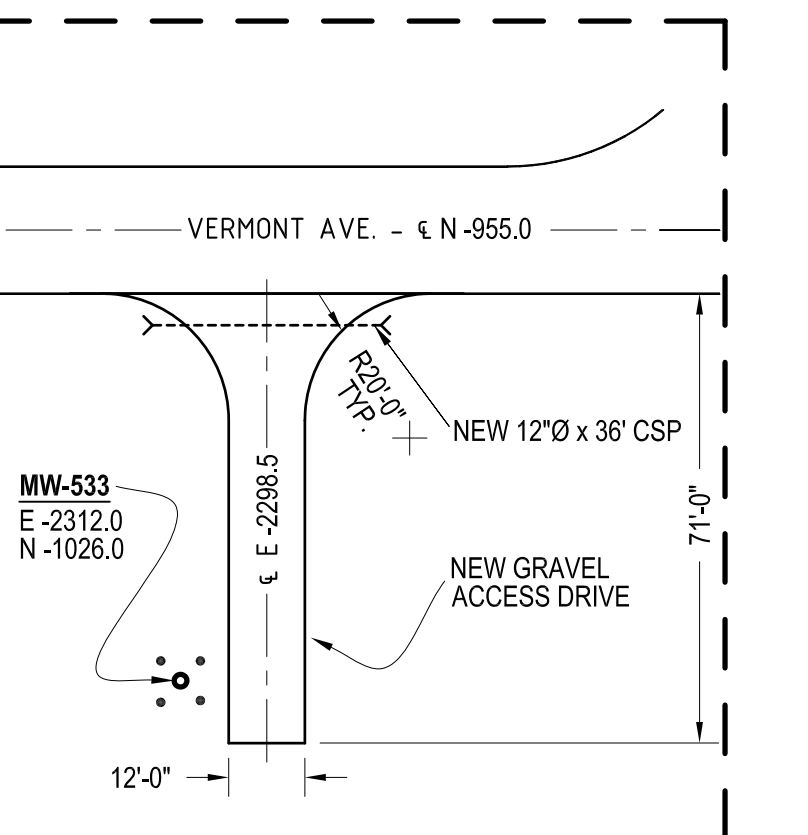
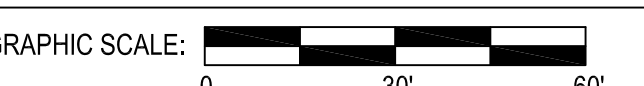

MW533 ACCESS ROAD DETAIL

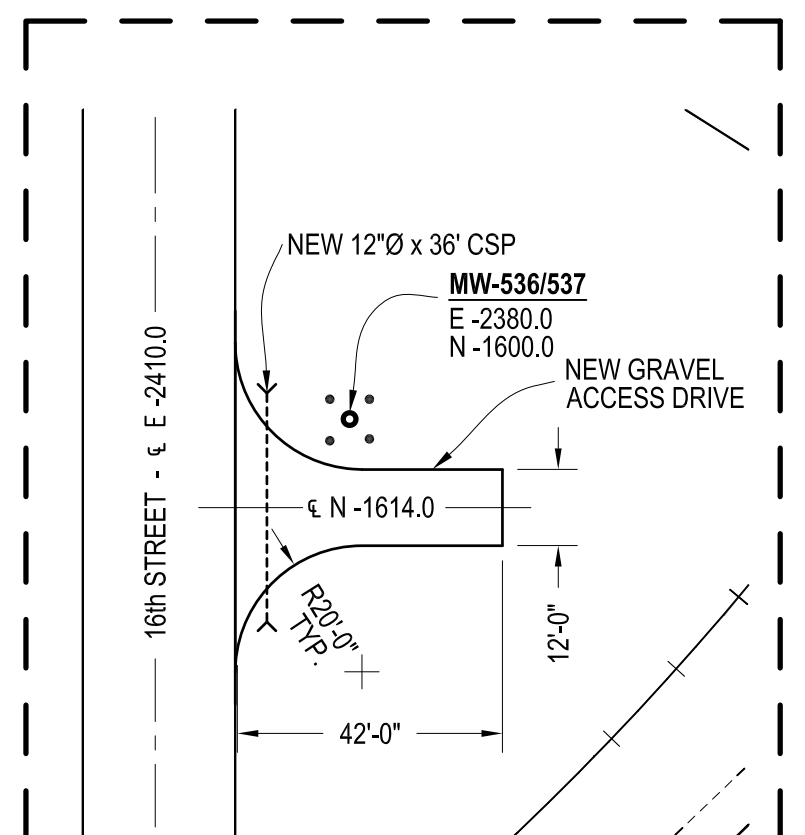
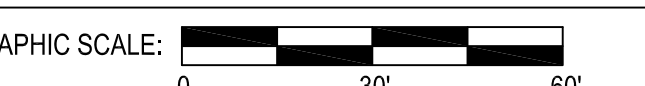

MW536/537 ACCESS ROAD DETAIL

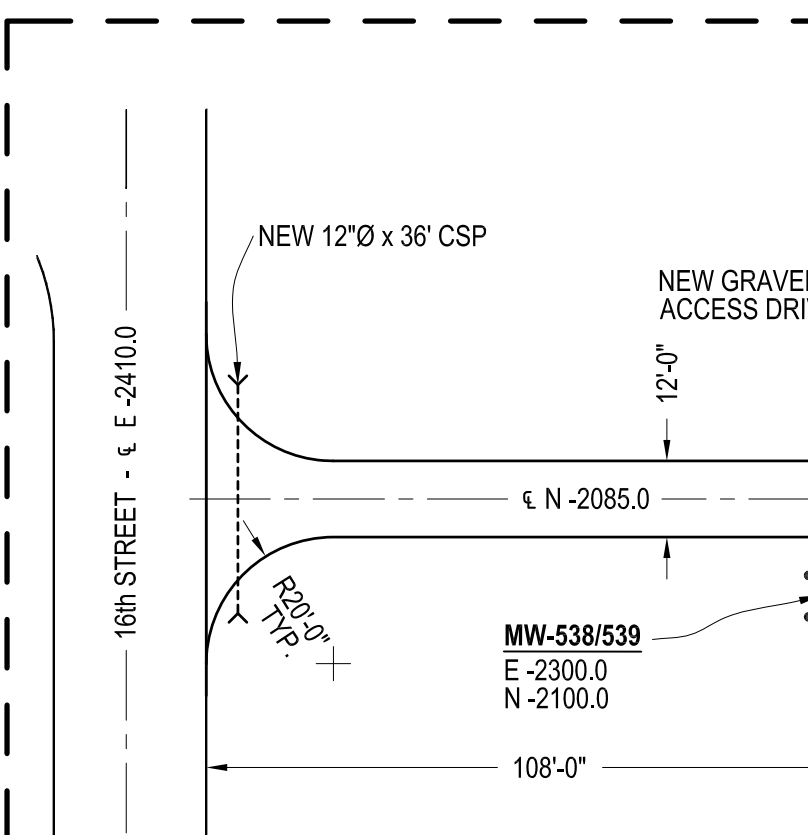
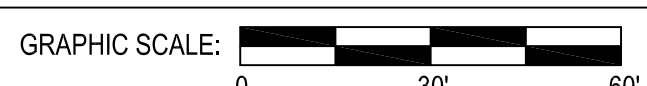

MW538/539 ACCESS ROAD DETAIL

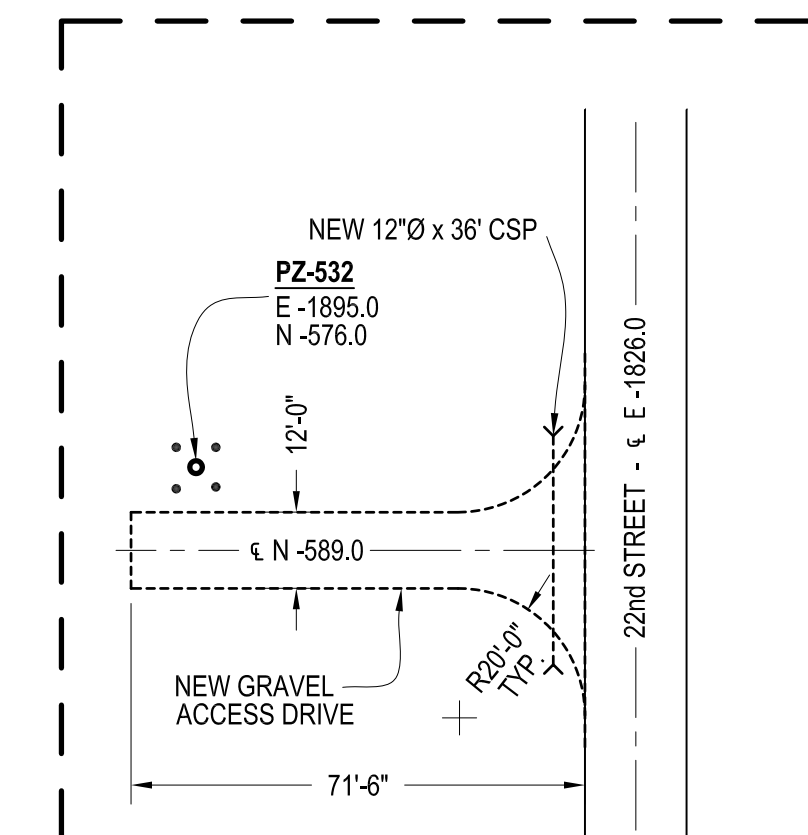
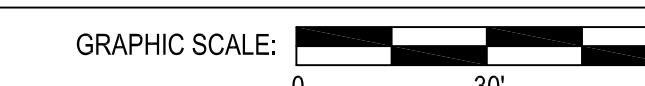

PZ532 ACCESS ROAD DETAIL

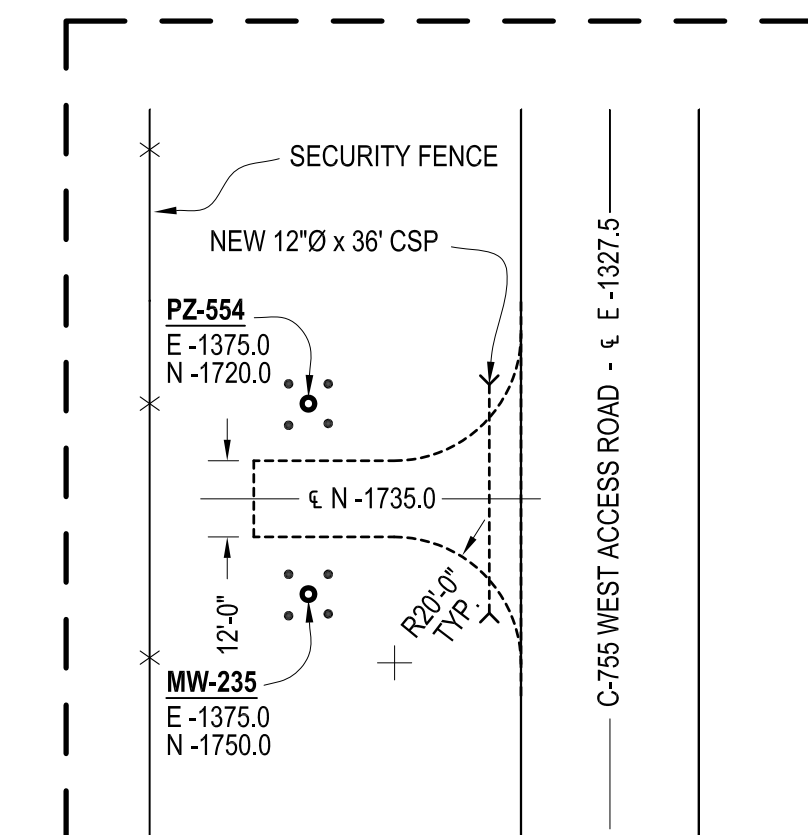
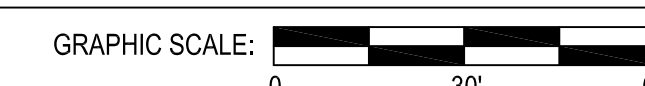

PZ554 & MW235 ACCESS ROAD DETAIL

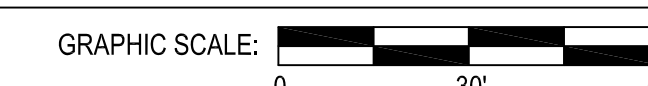

PRELIMINARY

THIS DRAWING PRODUCED ON AUTOCAD DO NOT REVISE MANUALLY

EXTRACTION WELL 234 AND 235 WELL DETAIL	C5E-FA1950-A06
GROUND WATER PIEZOMETER WELLS INSTALLATION DETAILS	C5E-FA1950-A12
GROUND WATER MONITORING WELLS INSTALLATION DETAILS	C7DCWELLSA003
GROUND WATER MONITORING WELLS TYPICAL WELL DETAILS	C7DCWELLSA002

REFERENCE DRAWINGS DRAWING NO.

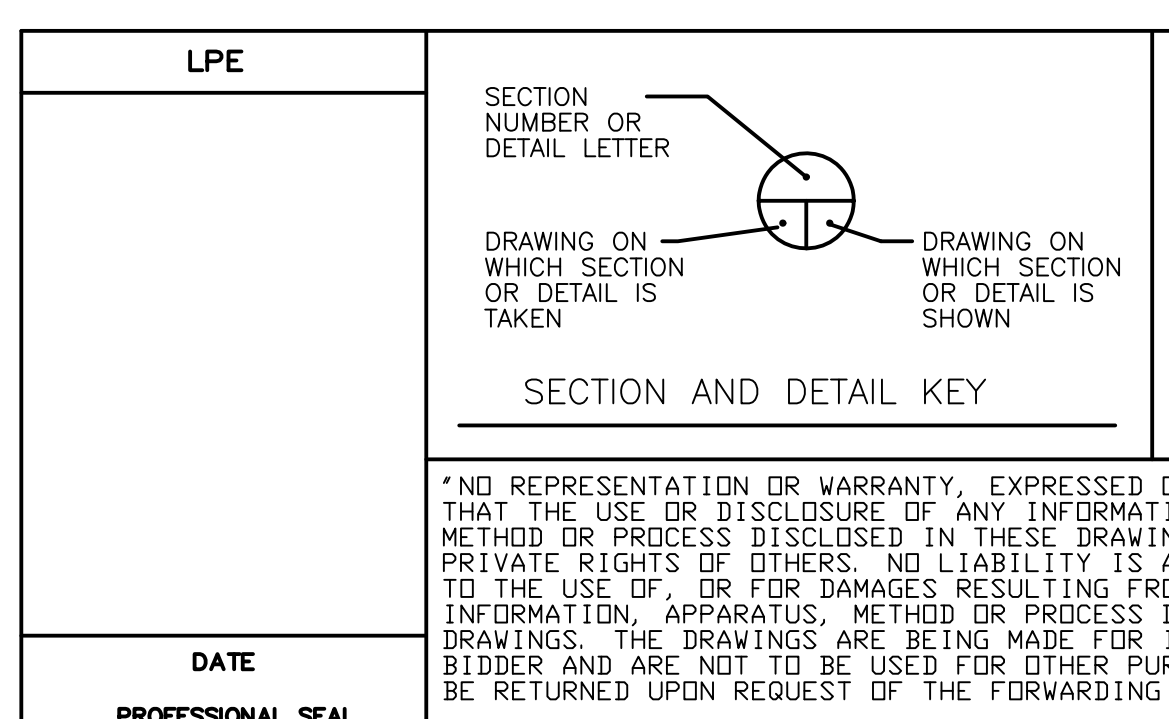

TOLERANCES UNLESS OTHERWISE SPECIFIED
 FRACTIONS ± 1/16"
 XX DECIMALS
 XXX DECIMALS
 ANGLES
 BREAK SHARP EDGES
 MAX. FINISH

DATE PROFESSIONAL SEAL

REV. NO.	ISSUE / REVISION DESCRIPTION	REVISION OR ISSUE APPROVALS							DRAWING APPROVALS				
		DATE	DRW	CHKR	RE	TR	APPD	DATE	DRW	CHKR	RE	APPD	
FA1	APPROVED FOR RELEASE FOR ESD FA1950		X	X	X	X	X						
	ISSUE / REVISION DESCRIPTION												

FLUOR PADUCAH DEACTIVATION PROJECT DOE Prime Contract #DE-DT000774

GENERAL OVERALL EXTRACTION WELL AND MONITORING WELL LOCATION PLAN

PRIORITY 3

SCALE NOTED	PLANT PGDP	BLDG N/A	FL N/A	CLASS U
ID FA1950	C5E-FA1950-A14			REV FA1

Feb 03, 2016

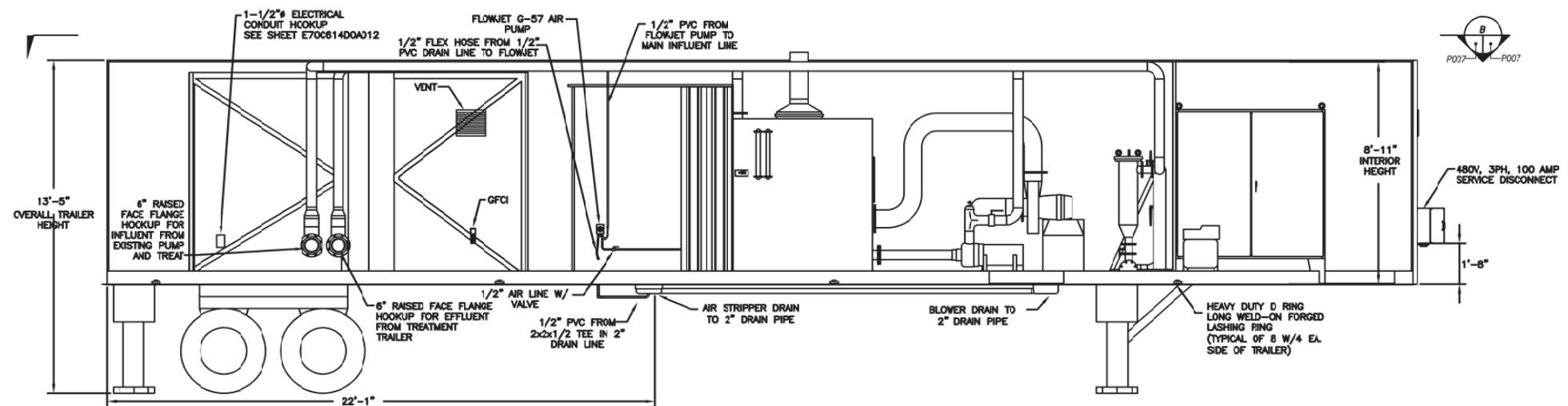

TREATMENT SYSTEM ELEVATION VIEW
SCALE: NONE

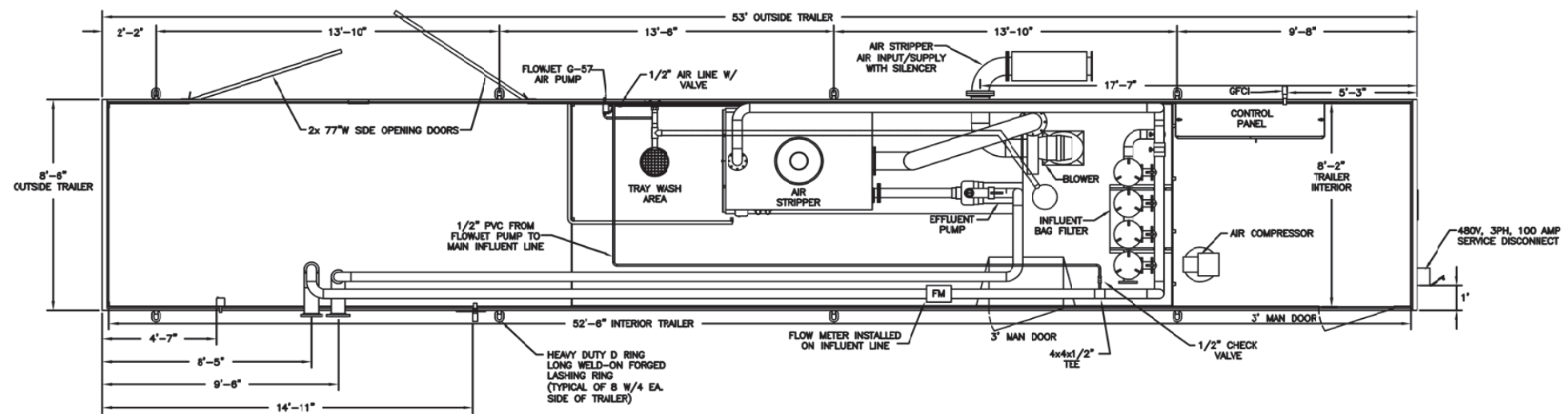

TREATMENT SYSTEM TOP VIEW
SCALE: NONE

THIS DRAWING
PRODUCED ON AUTOCAD
DO NOT REVISE MANUALLY

PRELIMINARY

SECTION NUMBER OR DETAIL LETTER	SECTION AND DETAIL KEY	TOLERANCES UNLESS OTHERWISE SPECIFIED
DRAWING ON WHICH SECTION OR DETAIL IS TAKEN	DRAWING ON WHICH SECTION OR DETAIL IS SHOWN	FRACTIONS TO 3 DECIMALS DIMENSIONS TO 2 DECIMALS ANGLES TO NEAREST MINUTE BREAK SHARP EDGES MAX. FINISH

THIS REPRESENTATION OR WARRANTY, EXPRESSED OR IMPLIED, IS MADE THAT THE USE OR DISCLOSURE OF ANY INFORMATION, APPARATUS, METHOD OR PROCESS, DISCLOSED IN THESE DRAWINGS, MAY NOT INFRINGE THE RIGHTS OF OTHERS. NO LIABILITY IS ASSUMED WITH RESPECT TO THE USE OF OR FOR DAMAGES RESULTING FROM THE USE. ANY INFORMATION, APPARATUS, METHOD OR PROCESS DISCLOSED IN THESE DRAWINGS, ARE BEING MADE FOR INFORMATION TO THE USER AND ARE NOT TO BE USED FOR OTHER PURPOSES, AND ARE TO BE RETURNED UPON REQUEST OF THE FURNISHING CONTRACTOR.

REV. NO.	ISSUE / REVISION DESCRIPTION	DATE	APPD	CHKD	DRW
FA1	APPROVED FOR RELEASE FOR ESD FA1950				

FLUOR , PADUCAH DEACTIVATION PROJECT DOE Prime Contract #DE-DT007774			
C-765-A GENERAL ARRANGEMENT			
PRIORITY 3			
SCALE: NONE	PLANT: PGDP	BLDG: C-765-A	FL: N/A
REV: FA1950	M5E-FA1950-A06		CLASS: U

Feb 04, 2016

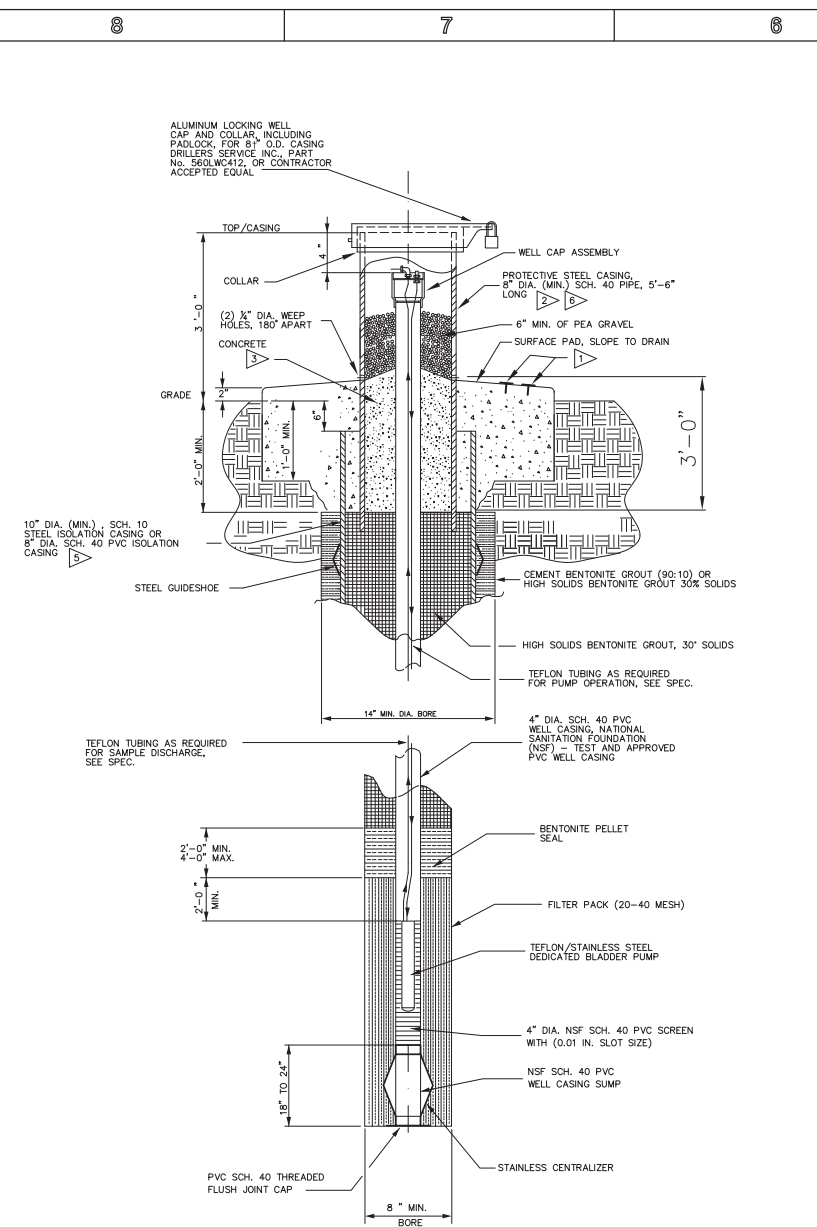

MONITORING WELL WITH ISOLATION CASING

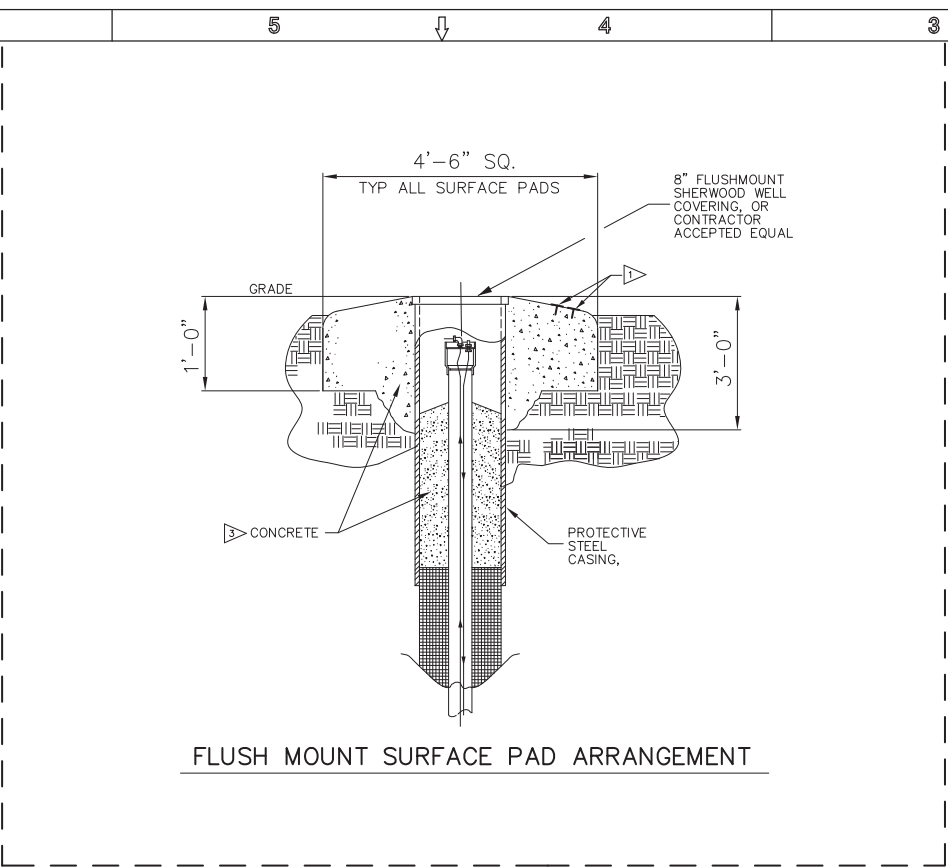

FLUSH MOUNT SURFACE PAD ARRANGEMENT

- GENERAL NOTES:**
- INSTALL TWO BRASS PLATE MONUMENTS. SUB-CONTRACTOR SHALL STAMP WELL NUMBER (MIN. OF 8" SIZE LETTERS) IN BRASS PLATE. BRASS PLATE SHALL BE DOME SURVEY MARKER 3" DIA. LET NUMBER 9134-19 OR CONTRACTOR ACCEPTED EQUAL.
 - PROTECTIVE CASING SHALL BE CLEANED ACCORDING TO SSPC-SP6 AND PRIMED WITH TNEC SERIES 37-77W @ 3-5 MILS AND FINISHED WITH TNEC SERIES 82-BW6 @ 2-3 MILS. OR CONTRACTOR ACCEPTED EQUAL.
 - CONCRETE FOR PAD AND PROTECTIVE WELL CASING SHALL BE CLASS "A" IN ACCORDANCE WITH KDI STANDARD SPECIFICATION SECTION 601
 - OMT
 - ISOLATION CASING TO BE INSTALLED IN CONFINING LAYER ABOVE RGA.
 - EACH PROTECTIVE CASING SHALL BE LABELED WITH BLACK LETTERS. LABEL SHALL INCLUDE THE PREFIX MW FOR MONITORING WELLS, THE PREFIX PZ FOR PIEZOMETERS AND THE NUMBER ASSIGNED BY THE CONTRACTOR. LETTERS SHALL BE A MINIMUM OF 2 INCHES HIGH.

GROUND WATER MONITORING WELLS TYPICAL WELL DETAILS	C7DCWELLSA002
REFERENCE DRAWINGS	DRAWING NO.

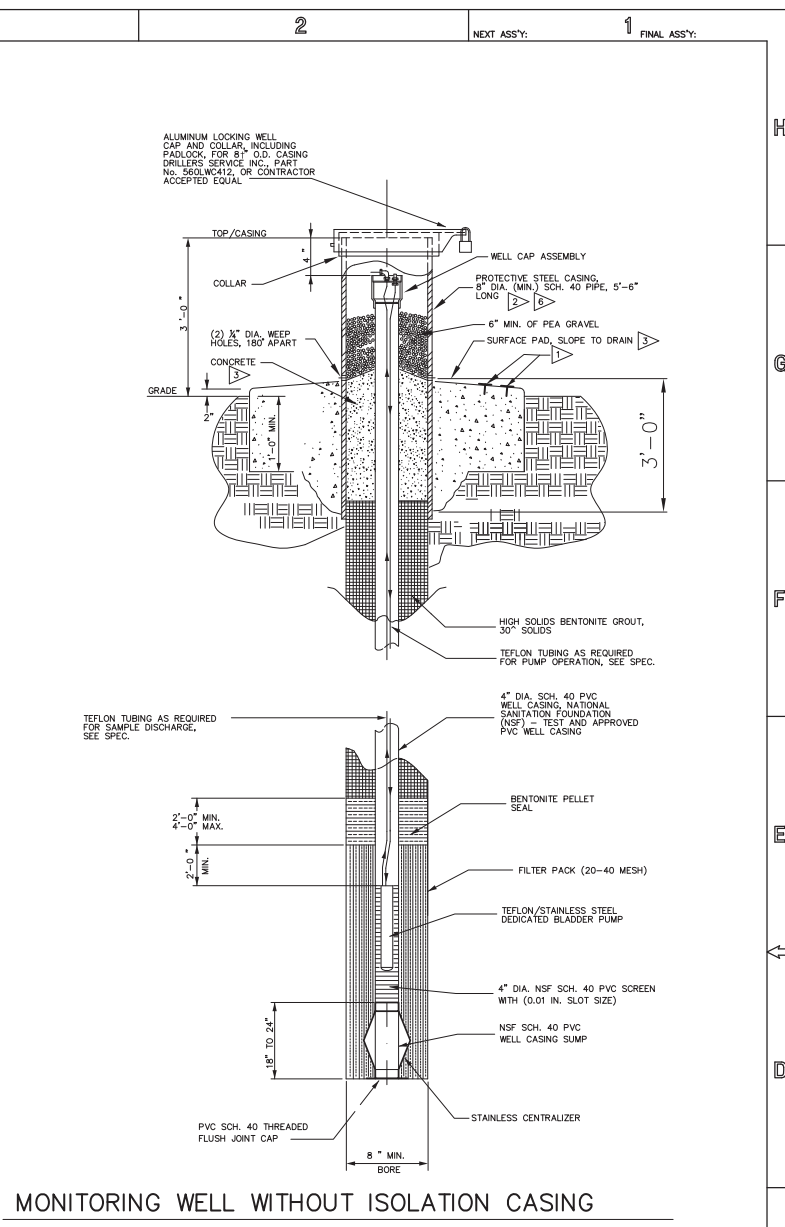

MONITORING WELL WITHOUT ISOLATION CASING

THIS DRAWING
PRODUCED ON AUTOCAD
DO NOT REVISE MANUALLY

PRELIMINARY

FLUOR PADUCAH DEACTIVATION PROJECT
DOE Prime Contract #DE-DT000774

GROUND WATER MONITORING WELLS INSTALLATION DETAILS

PRIORITY 3

SCALE	PLANT	BLDG	FL	CLASS
NONE	PGDP	N/A	N/A	U
ID	FA1950	C7DCWELLSA003		FA1

SECTION NUMBER OR DETAIL LETTER	DRAWING ON WHICH SECTION OR DETAIL IS SHOWN	TOLERANCES UNLESS OTHERWISE SPECIFIED	DATE	REV.	ISSUE / REVISION DESCRIPTION	DATE	REV.	ISSUE / REVISION DESCRIPTION	DATE	REV.	ISSUE / REVISION DESCRIPTION
FA1					APPROVED FOR RELEASE FOR ESD FA1950						

LPE

SECTION AND DETAIL KEY

DATE PROFESSIONAL SEAL

[Jan 06, 2016]

BUMPER POST, TYP EACH CORNER, SEE DETAIL THIS SHEET

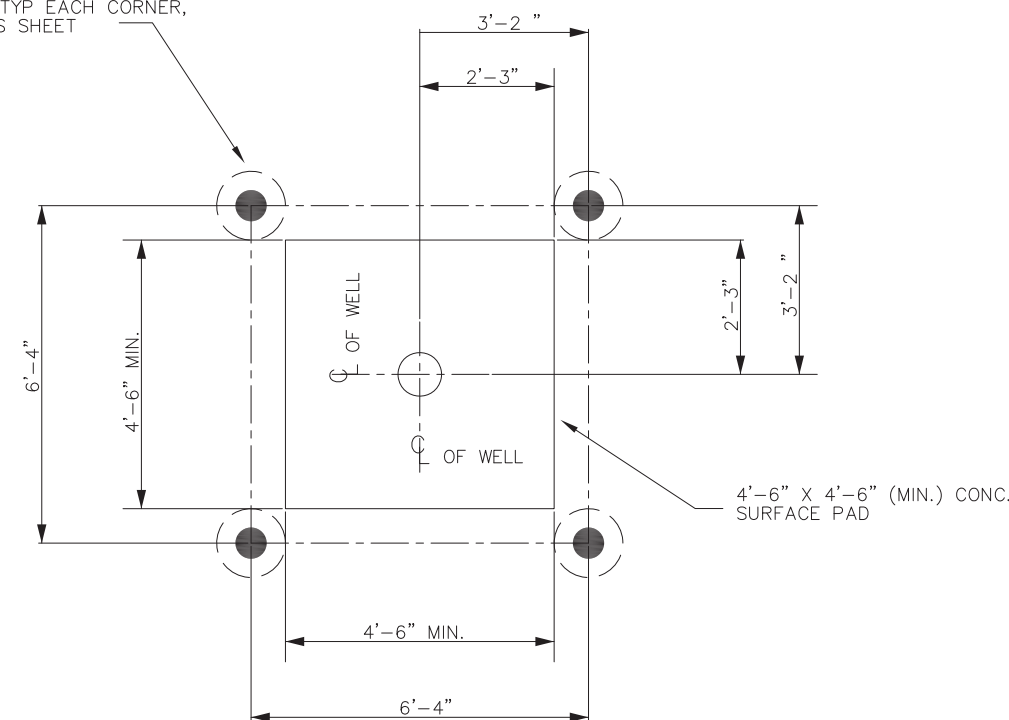

CONCRETE PAD AND BOLLARD LOCATION PLAN 3

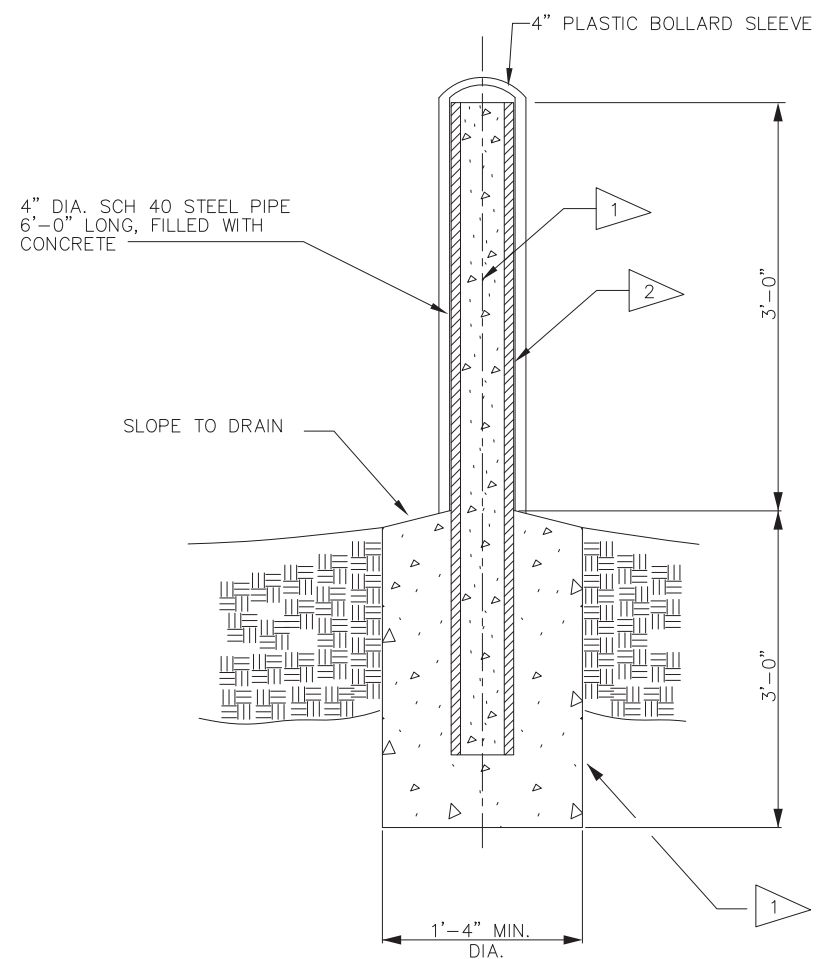

TYPICAL BOLLARD DETAIL

GENERAL NOTES:

- 1 CONCRETE FOR BOLLARDS SHALL BE CLASS "A" IN ACCORDANCE WITH KDH STANDARD SPECIFICATION SECTION 601.
- 2 BOLLARD SHALL BE CLEANED ACCORDING TO SSPC-SP6 AND PRIMED WITH TNEVEC SERIES 37-77W @ 3-5 MILS OR COMPANY ACCEPTED EQUAL. AFTER PRIMING IS COMPLETE INSTALL PLASTIC BOLLARD POST SLEEVE (1/4" THICK MINIMUM). TRIM EXCESS LENGTH AS REQUIRED TO MATCH HEIGHT OF CONCRETE BOLLARD.
- 3 PAD AND BOLLARDS ARE NOT REQUIRED ON TEMPORARY PIEZOMETERS

GROUND WATER PIEZOMETER WELLS INSTALLATION DETAILS	C5E-FA1950-A12
GROUND WATER MONITORING WELLS INSTALLATION DETAILS	C7DCWELLSA003
REFERENCE DRAWINGS	DRAWING NO.

THIS DRAWING
PRODUCED ON AUTOCAD
DO NOT REVISE MANUALLY

PRELIMINARY

LPE	SECTION NUMBER OR DETAIL LETTER DRAWING ON WHICH SECTION OR DETAIL IS TAKEN	TOLERANCES UNLESS OTHERWISE SPECIFIED FRACTIONS ± 1/16" XX DECIMALS XXX DECIMALS ANGLES BREAK SHARP EDGES MAX. FINISH
DATE	SECTION AND DETAIL KEY	
PROFESSIONAL SEAL	NO REPRESENTATION OR WARRANTY, EXPRESSED OR IMPLIED, IS MADE THAT THE USE OR DISCLOSURE OF ANY INFORMATION, APPARATUS, METHOD OR PROCESS DISCLOSED IN THESE DRAWINGS MAY NOT INFRINGE PRIVATE RIGHTS OF OTHERS. NO LIABILITY IS ASSUMED WITH RESPECT TO THE USE OF OR FOR DAMAGES RESULTING FROM THE USE AND INFORMATION, APPARATUS, METHOD OR PROCESS DISCLOSED IN THESE DRAWINGS. THE DRAWINGS ARE BEING MADE FOR INFORMATION TO BIDDER AND ARE NOT TO BE USED FOR OTHER PURPOSES, AND ARE TO BE RETURNED UPON REQUEST OF THE FORWARDING CONTRACTOR.	

REV. NO.	DATE	ISSUE / REVISION DESCRIPTION	DATE	REV	CHKR	APPD	DATE
FA1		APPROVED FOR RELEASE FOR ESD FA1950		X	X	X	X
				X	X	X	X
				X	X	X	X
				X	X	X	X
				X	X	X	X

FLUOR PADUCAH DEACTIVATION PROJECT
DOE Prime Contract #DE-DT000774

GROUND WATER MONITORING
WELLS TYPICAL WELL
DETAILS

PRIORITY 3

SCALE	PLANT	BLDG	FL	CLASS
NONE	FGDP	N/A	N/A	U
ID	FA1950	C7DCWELLSA002		FA1

ABBREVIATIONS

BA	BALL VALVE
BV	BUTTERFLY VALVE
CV	CHECK VALVE
DPT	DIFFERENTIAL PRESSURE TRANSMITTER
EQ	EQUALIZATION
EW	EXTRACTION WELL
FAL	FLOW ALARM LOW
FE	FLOW ELEMENT
FI	FLOW INDICATOR
FQI	FLOW INDICATING TOTALIZER
FQIT	FLOW INDICATING TOTALIZER TRANSMITTER
GAC	GRANULAR ACTIVATED CARBON
HDPE	HIGH-DENSITY POLYETHYLENE
HOA	HAND-OFF-AUTO
HS	HAND SWITCH
KQI	RUN TIME TOTALIZER
LAHH	LEVEL ALARM HIGH-HIGH
LC	LEVEL CONTROL
LE	LEVEL ELEMENT
LI	LEVEL INDICATOR
LIT	LEVEL INDICATING TRANSMITTER
LSHH	LEVEL SWITCH HIGH-HIGH
MV	MOTORIZED VALVE
PAH	PRESSURE ALARM HIGH
PALL	PRESSURE ALARM LOW-LOW
PI	PRESSURE INDICATOR
PS	PRESSURE SWITCH
PT	PRESSURE TRANSMITTER
PVC	POLYVINYL CHLORIDE
SIC	SPEED INDICATING CONTROL
VFD	VARIABLE FREQUENCY DRIVE
XA	MOTOR ALARM
XC	MOTOR ENABLE
XS	MOTOR STATUS
YIC	EVENT INDICATING CONTROL
ZA	POSITION ALARM
ZI	POSITION INDICATION

PUMPS, BLOWERS, AND COMPRESSORS (MOTOR DRIVEN)	MEDIA SEPARATORS, FILTERS, AND CONTAINMENT	PIPING AND LINE SYMBOLS	VALVES - PROCESS, CONTROL, AND RELIEF	PLUMBING PARTS AND CONNECTORS	TRANSDUCERS (4-20mA)	VALVE TAGS	ELECTICAL CONTROLS
BLOWER (CENTRIFUGAL FAN) LIQUID RING VACUUM PUMP CENTRIFUGAL PUMP CHEMICAL PUMP PROGRESSIVE CAVITY PUMP HEAT EXCHANGER SUMP PUMP AIR COMPRESSOR	KNOCK OUT TANK OIL WATER SEPARATOR AIR STRIPPER CARBON VESSEL (LIQUID/VAPOR) SAND FILTER BAG FILTER PRODUCT DRUM FLOOR SUMP CONTAINMENT FILTER (IN LINE)	PROCESS LINE FLEX HOSE ELECTRICAL PNEUMATIC HYDRAULIC TRAILER LIMITS PROCESS FLOW PROCESS LINE DESIGNATION PIPE SIZE PIPE SCH MATERIAL MATERIAL GUIDE: SS - STAINLESS STEEL GS - GALVANIZED STEEL CS - CARBON STEEL FH - FLEX HOSE PVC - POLYVINYL CHLORIDE CPV - CHLORINATED POLYVINYL CHLORIDE ABBREVIATIONS: GPM - GALLONS PER MINUTE CFM - CUBIC FEET PER MINUTE PRV - PRESSURE RELIEF VALVE VRV - VACUUM RELIEF VALVE XP - EXPLOSION PROOF	BALL VALVE (OPEN) BALL VALVE (CLOSED) 3 WAY BALL VALVE GATE VALVE (OPEN) GATE VALVE (CLOSED) BUTTERFLY VALVE CHECK VALVE SOLENOID VALVE MOTOR OPERATED VAPOR CONTROL VALVE PRESSURE REGULATOR VALVE PRESSURE/VACUUM RELIEF VALVE ANTI SIPHON VALVE AUTO AIR BLEED FLOW CONTROL VALVE FLAME ARRESTOR CONTROL VALVE (2 WAY) CONTROL VALVE (3 WAY)	REDUCER MALE CAM LOCK HOSE CONNECTOR FEMALE CAM LOCK HOSE CONNECTOR CAM LOCK CAP SITE GLASS UNION FLANGE PIPE PLUG FURNCO Y STRAINER BASKET STRAINER FLOW METERS LIQUID FLOW METER VAPOR FLOW METER	PRESSURE TRANSDUCER VACUUM TRANSDUCER TEMPERATURE TRANSDUCER DIFFERENTIAL PRESSURE TRANSDUCER LEVEL TRANSDUCER PH METER TRANSDUCER TURBIDITY METER TRANSDUCER FLOW TRANSDUCER HUMIDITY TRANSDUCER GAUGE INDICATORS PRESSURE GAUGE INDICATOR VACUUM GAUGE INDICATOR TEMPERATURE GAUGE INDICATOR DIFFERENTIAL PRESSURE GAUGE INDICATOR LEVEL GAUGE INDICATOR FLOW GAUGE INDICATOR HUMIDITY GAUGE INDICATOR	BALL VALVE BUTTERFLY VALVE SAMPLE PORT VALVE DRAIN VALVE BYPASS LOOP VALVE PRODUCT VALVE AMBIENT BREATHER VALVE AUTOMATED VALVE INJECTION PORT VALVE BLOW DOWN COMPRESSED AIR VALVE SWITCHES LEVEL SWITCH LOW LEVEL SWITCH HIGH LEVEL SWITCH HIGH/HIGH TEMPERATURE SWITCH HIGH PRESSURE SWITCH HIGH FLOW SWITCH THERMOSTAT	HAND-OFF-AUTO SWITCH DISCRETE INPUT ANALOG INPUT DISCRETE OUTPUT ANALOG OUTPUT INTERLOCK CONTROL DIFFERENTIAL PRESSURE ALARM LEVEL HIGH SET POINT ALARM LEVEL LOW/LOW SET POINT ALARM LEVEL LOW SET POINT ALARM LEVEL HIGH SET POINT ALARM LEVEL HIGH/HIGH SET POINT ALARM INDICATOR EMERGENCY SHUT DOWN CONTROL ROOM EMERGENCY SHUT DOWN PROCESS ROOM

NOTE: LEGEND IS A STANDARD MECHANICAL LEGEND. NOT ALL ITEMS OR EQUIPMENT AS DESIGNATED HEREON ARE USED ON THIS PROJECT.

THIS DRAWING PRODUCED ON AUTOCAD
 DO NOT REVISE MANUALLY

PRELIMINARY

FLUOR PADUCAH DEACTIVATION PROJECT
 DOE Prime Contract #DE-DT000774

LEGENDS AND ABBREVIATIONS

PRIORITY 3

LPE	SECTION NUMBER OR DETAIL LETTER	TOLERANCES UNLESS OTHERWISE SPECIFIED
	DRAWING ON WHICH SECTION OR DETAIL IS TAKEN	FRACTIONS ± 1/16"
	DRAWING ON WHICH SECTION OR DETAIL IS SHOWN	XX DECIMALS
	SECTION AND DETAIL KEY	XXX DECIMALS
		ANGLES
		BREAK SHARP EDGES MAX.
		FINISH

DATE	PROFESSIONAL SEAL	NO REPRESENTATION OR WARRANTY, EXPRESSED OR IMPLIED, IS MADE THAT THE USE OR DISCLOSURE OF ANY INFORMATION, APPARATUS, METHOD OR PROCESS DISCLOSED IN THESE DRAWINGS MAY NOT INFRINGE PRIVATE RIGHTS OF OTHERS. NO LIABILITY IS ASSUMED WITH RESPECT TO THE USE OF, OR FOR DAMAGES RESULTING FROM THE USE OF ANY INFORMATION, APPARATUS, METHOD OR PROCESS DISCLOSED IN THESE DRAWINGS. THE DRAWINGS ARE BEING MADE FOR INFORMATION TO BIDDER AND ARE NOT TO BE USED FOR OTHER PURPOSES, AND ARE TO BE RETURNED UPON REQUEST OF THE FORWARDING CONTRACTOR.
FA1	APPROVED FOR RELEASE FOR ESO FA1950	
REV. NO.	ISSUE / REVISION DESCRIPTION	
	DATE	DRW
	CHKR	RE
	TR	APPD
	DATE	DATE

SCALE	NONE	PLANT	PGDP	BLDG	N/A	FL	N/A	CLASS	U
ID	FA1950	15E-FA1950-A01		REV	FA1				

Jan 06, 2016

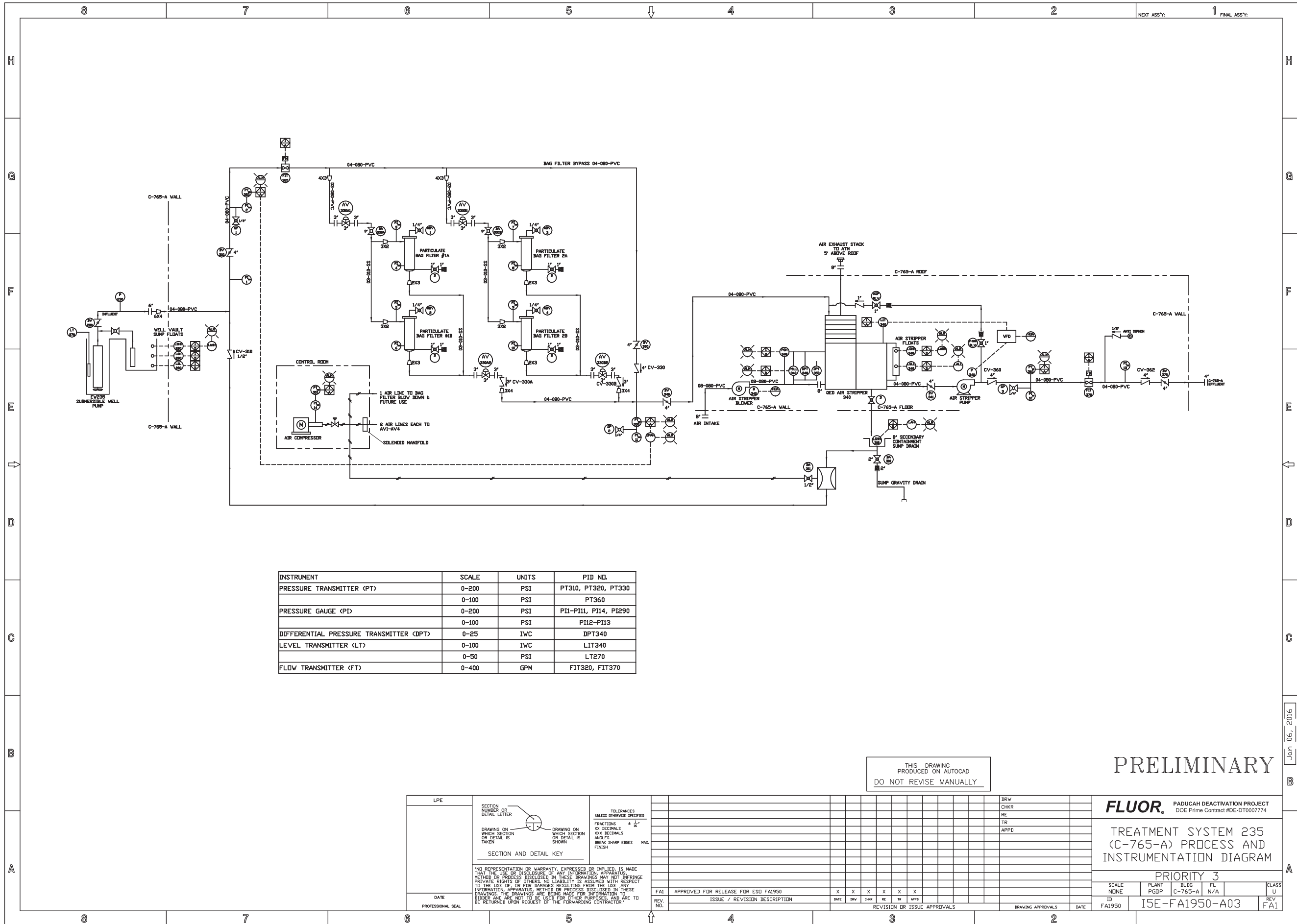

INSTRUMENT	SCALE	UNITS	PID NO.
PRESSURE TRANSMITTER (PT)	0-200	PSI	PT310, PT320, PT330
PRESSURE GAUGE (PG)	0-100	PSI	PT360
PRESSURE TRANSMITTER (PT)	0-200	PSI	PI12-PI13
DIFFERENTIAL PRESSURE TRANSMITTER (DPT)	0-25	IWC	DPT340
LEVEL TRANSMITTER (LT)	0-100	IWC	LIT340
LEVEL TRANSMITTER (LT)	0-50	PSI	LT270
FLOW TRANSMITTER (FT)	0-400	GPM	FIT320, FIT370

THIS DRAWING
PRODUCED ON AUTOCAD
DO NOT REVISE MANUALLY

PRELIMINARY

SECTION NUMBER OR DETAIL LETTER	DRAWING ON WHICH SECTION OR DETAIL IS SHOWN	TOLERANCES UNLESS OTHERWISE SPECIFIED
FRACTIONS	± 1/16"	
XX DECIMALS		
XXX DECIMALS		
ANGLES		
BREAK SHARP EDGES	MAX.	
FINISH		

DATE	REV.	ISSUE / REVISION DESCRIPTION	DATE	REV.	ISSUE / REVISION DESCRIPTION

FLUOR PADUCAH DEACTIVATION PROJECT DOE Prime Contract #DE-DT0007774				
TREATMENT SYSTEM 235 (C-765-A) PROCESS AND INSTRUMENTATION DIAGRAM				
PRIORITY 3				
SCALE	PLANT	BLDG	FL	CLASS
NONE	PGDP	C-765-A	N/A	U
ID	FA1950-FA1950-A03		REV	FA1

Jan 06, 2016

APPENDIX B

AIR DISPERSION ANALYSIS

THIS PAGE INTENTIONALLY LEFT BLANK

B.1. AIR DISPERSION ANALYSIS

B.1.1 INTRODUCTION

As a result of the cessation of uranium enrichment operations at Paducah Gaseous Diffusion Plant (PGDP), the use of the C-637 Cooling Towers as an air stripper facility for trichloroethene (TCE)-contaminated groundwater was discontinued for this Interim Remedial Action (IRA). After PGDP ceased operations and prior to completion of the Northeast Plume IRA Optimization project, one Northeast Plume treatment unit (TU), located near the planned location for EW234, is being used temporarily to continue treatment of groundwater from the two existing Northeast Plume extraction wells (EW331 and EW332) until EW234 and EW235 begin operation. The TU systems include, at minimum, a skid-mounted treatment system consisting of a high efficiency air stripper, air blower, effluent pump, influent bag filters, and process control system all enclosed in a heated weatherproof enclosure. In addition, the EW234 TU includes a tie-in point to the existing Northeast Plume IRA extraction wells. Two separate TUs will be used to treat extracted water from each new extraction well, one TU for EW234 and one TU for EW235, and will be located in the same general area as the new extraction wells.

This appendix describes the air dispersion analysis of potential hazardous air pollutant (HAP) and/or toxic air pollutant (TAP) emissions after implementation of the Northeast Plume IRA Optimization project is complete, and EW234 and EW235 have begun operation. The property boundary concentrations for potential HAP/TAP emissions were estimated using BREEZE AERMOD Version 7.7.1. Report printouts and electronic model-ready input files are included in the attachment to this appendix. The results of the dispersion analysis are summarized herein.

Air Dispersion Model Selection

The BREEZE AERMOD Version 7.7.1 program was used to conduct air dispersion modeling using the latest version (12345) of the American Meteorological Society/Environmental Protection Agency Regulatory Model (AERMOD) to estimate maximum ground-level concentrations. AERMOD is a steady-state plume model that incorporates air dispersion based on planetary boundary layer turbulence structure and scaling concepts, including treatment of both surface and elevated sources, and both simple and complex terrain.

Modeling Receptor Grids

Ground-level concentrations were calculated within one Cartesian receptor grid and at receptors placed along the property line (property line). The property line grid receptors were spaced at a maximum of approximately 50 m apart. The Cartesian receptor grid extending out a minimum of 600 m beyond the property line was spaced at 200-m intervals in all directions. The Cartesian receptor grid was generated to ensure concentrations were decreasing away from the property line. All resultant maximum concentrations occur well within this distance.

Terrain

AERMOD uses advanced terrain characterization to account for the effects of terrain features on plume dispersion and travel. AERMOD's terrain preprocessor, AERMAP (latest version 11103), imports digital terrain data and computes a height scale for each receptor from National Elevation Dataset (NED) data files. A height scale is assigned to each individual receptor and is used by AERMOD to determine whether the plume will go over or around a hill.

The modeled receptor terrain elevations input into AERMAP are the highest elevations extracted from United States Geological Survey 1:24,000 scale (7.5-minute series) NED data for the area surrounding PGDP. For each modeled receptor, the maximum possible elevation within a box centered on the receptor of concern and extending halfway to each adjacent modeled receptor was chosen. This is a conservative technique for estimating terrain elevations by ensuring that the highest terrain elevations are accounted for in the analysis. HAP/TAP emission concentrations were calculated at all receptors.

Building Downwash Analysis

The emission units were evaluated in terms of their proximity to nearby structures.¹ The purpose of this evaluation was to determine if stack discharge might become caught in the turbulent wakes of these structures leading to downwash of the plume. Wind blowing around a building creates zones of turbulence that are greater than if the building were absent. The current version of the AERMOD dispersion model treats building wake effects following the algorithms developed by Schulman and Scire.² This approach requires the use of wind direction-specific building dimensions for structures located within 5L of a stack, where L is the lesser of the height or projected width of a nearby structure. Stacks taller than the structure height plus 1.5L are not subject to the effects of downwash in the AERMOD model.

The current version of the AERMOD dispersion model considers the trajectory of the plume near a building and uses the position of the plume relative to the building to calculate interaction with the building wake. The direction-specific building dimensions used as inputs to the AERMOD model were calculated using the **Building Profile Input Program Plume Rise Model Enhancement (BPIP PRIME)**, version 04274.³ BPIP PRIME calculates fields of turbulence intensity, wind speed, and the slopes of the mean streamlines as a function of the projected building dimensions. BPIP PRIME is authorized by the U.S. Environmental Protection Agency (EPA) and is designed to incorporate the concepts and procedures expressed in the Good Engineering Practice (GEP) Technical Support document,⁴ the Building Downwash Guidance document, and other related documents.

BPIP PRIME results indicate the stack height of each emission unit is greater than the GEP stack height; therefore, building downwash is not a concern. The input and output files used in the BPIP PRIME downwash analysis are included in the attachment to this appendix. The output file lists: the names and dimensions of the structures considered; the emissions unit locations and heights; a summary of the dominant structure for each emissions unit (considering all wind directions); and the actual building height and projected widths for all wind directions. Each building processed using BPIP PRIME was assigned a unique numerical identification, which correspond to BPIP PRIME files, and are illustrated in Figure B.1.

¹ Buildings located farther than 800 m or 2,625 ft of a stack were not considered in the building downwash analysis, <http://www.epa.state.oh.us/portals/27/aqmp/eiu/attach2.pdf>.

² Earth Tech, Inc., *Addendum to the ISC3 User's Guide, The PRIME Plume Rise and Building Downwash Model*, Concord, MA.

³ EPA, *User's Guide to the Building Profile Input Program*, (Research Triangle Park, NC: U.S. EPA), EPA-454/R-93-038.

⁴ EPA, Office of Air Quality Planning and Standards, *Guidelines for Determination of Good Engineering Practice Stack Height (Technical Support Document for the Stack Height Regulations)* (Revised), (Research Triangle Park, NC: U.S. EPA), EPA 450/4-80-023R, June 1985.

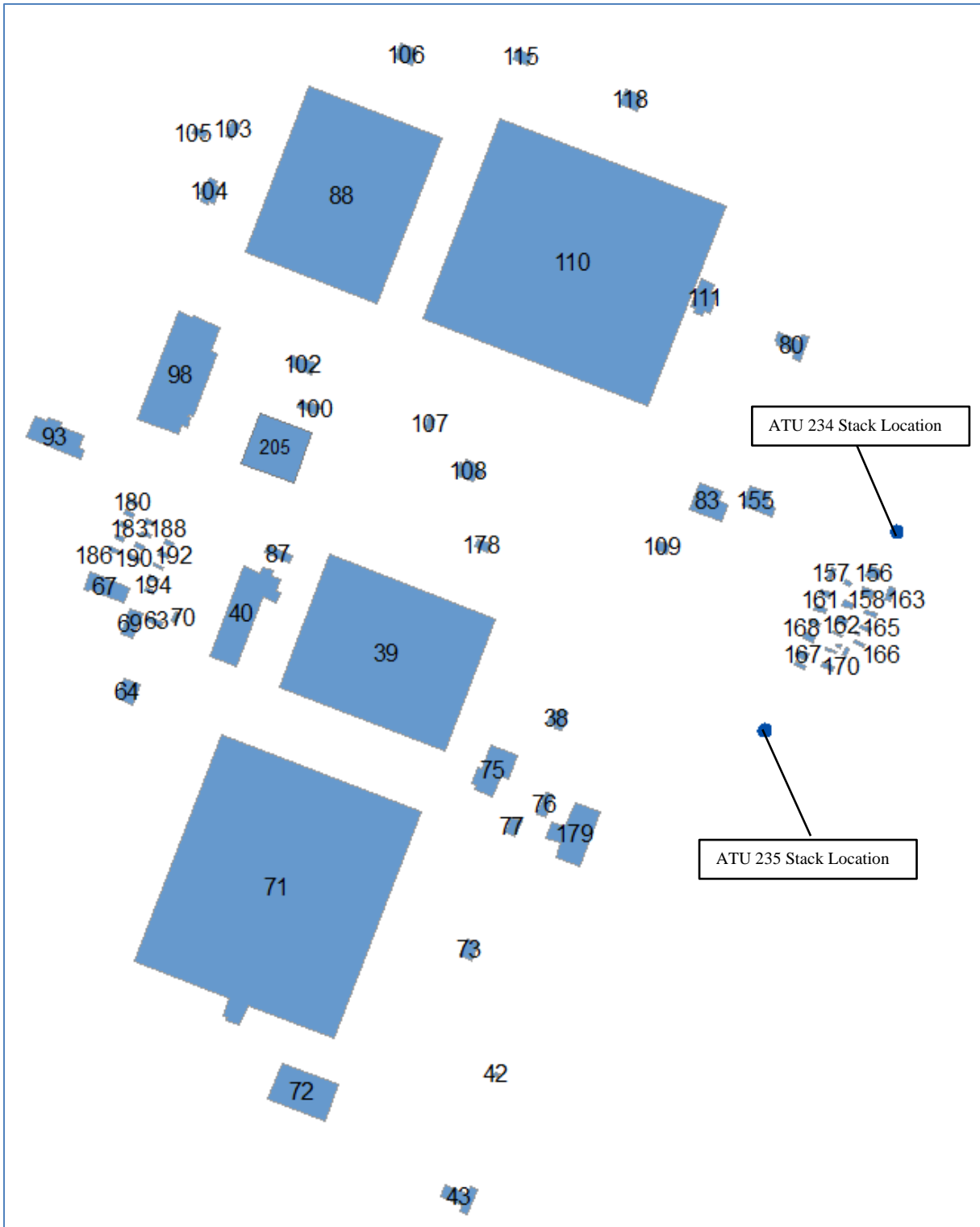

Figure B.1. Buildings Processed Using BPIP PRIME

B.1.2 IDENTIFICATION OF AIR POLLUTANTS

The potential HAPs/TAPs that could be emitted by the Northeast Plume IRA Optimization project have been identified based on groundwater characterization. The potential HAPs/TAPs that could be emitted are TCE and 1,1-dichloroethene (1,1-DCE).

B.1.3. ALLOWABLE OFF-SITE CONCENTRATIONS CALCULATIONS

The emitted vapor/gases must comply with the contaminant concentration requirements of 401 KAR 63:020. This states that no owner or operator shall allow any affected facility to emit potentially hazardous matter or toxic substances in such quantities or duration as to be harmful to the health and welfare of humans, animals, and plants.

B.1.3.1 TCE Allowable Off-site Concentrations

The maximum allowable air concentration for TCE was estimated using the EPA Region 9 Regional Screening Levels (RSLs), formerly referred to as Preliminary Remediation Goals, which are available from the EPA's Web site at: <http://www.epa.gov/region9/superfund/prg/index.html>. The TCE value is based on the carcinogenic risk posed by lifetime⁵ exposure to TCE. The health effects of exposure to TCE are measured by a target risk of one in one million (1×10^{-6}). The residential RSL was used to develop an allowable off-site concentration limit.

The ambient air allowable off-site concentration for TCE is $0.43 \mu\text{g}/\text{m}^3$. The allowable off-site concentration for TCE was selected from the EPA publication of RSLs (May 2013). (Note: The air dispersion analysis was performed in May 2013.)

B.1.3.2 1,1-DCE Allowable Off-Site Concentrations

The maximum allowable air concentration for 1,1-DCE also was estimated using the EPA RSL. The 1,1-DCE value is based on the noncancer risks posed by long-term exposure to 1,1-DCE. The health effects of exposure to 1,1-DCE are measured by a hazardous index, with a hazard index of 1 being an indication of the nearest off-site receptor having detrimental health effects from exposure to 1,1-DCE. The residential RSL was used to develop an allowable off-site concentration limit.

The ambient air allowable off-site concentration for 1,1-DCE is $210 \mu\text{g}/\text{m}^3$. The allowable off-site concentration for 1,1-DCE was selected from the EPA publication of RSLs (May 2013). (Note: The air dispersion analysis was performed in May 2013.)

The allowable off-site concentrations for TCE and 1,1-DCE are shown in Table B.1.

⁵ Lifetime exposure is assumed to be 70 years by convention for this air toxics risk assessment. http://www.epa.gov/reg3hwmd/risk/human/rb-concentration_table/usersguide.htm. In such assessments, if exposure duration is less than 70 years, inhalation exposure estimates and/or allowable off-site concentrations limits may be adjusted accordingly. http://epa.gov/ttn/fera/risk_atra_vol2.html. For simplicity in this report, allowable off-site concentration limits were not adjusted although exposure duration is expected to be less than 70 years for this project.

Table B.1. Allowable Off-site Concentration Limits

Pollutant	Allowable Off-Site Concentration ($\mu\text{g}/\text{m}^3$)	Reference Source
TCE	0.43	Regional Screening Levels, May 2013*
1,1-DCE	210	

*Air dispersion analysis performed May 2013.

B.1.3.3 Update of RSLs

EPA last updated the RSL table in June 2015. The carcinogenic screening level for TCE (RSL used for modeling) has increased from 0.43 $\mu\text{g}/\text{m}^3$ in May 2013 to 0.48 $\mu\text{g}/\text{m}^3$ in June 2015 while the current noncarcinogenic screening level for 1,1-DCE (RSL used for modeling) remains the same as in May 2013 (210 $\mu\text{g}/\text{m}^3$). As such, decisions based on the May 2013 modeling results remain protective. Off-site impacts will be less than the current RSLs.

B.1.4 ESTIMATED EMISSION RATES

B.1.4.1 Emissions

During operation of the project, hazardous constituents in extracted groundwater will be volatilized using two identical TUs including, but limited to, a skid-mounted treatment system consisting of a high efficiency 4-tray air stripper (QED EZ-Tray P/N EZ-24.4SS),⁶ air blower, effluent pump, influent bag filters, and process control system all enclosed in a heated weatherproof enclosure. The current design criteria for the TUs are for each air stripper to have a removal efficiency of up to 99% for volatile organic compounds.⁷ No vapor phase controls to capture or destroy contaminants prior to release to the atmosphere following stripping are included in the TUs at this time.

The following preliminary design parameters⁸ for the stack were used in the model to estimate the dispersion of the hazardous constituents:

- 8-inch diameter
- 19.5-ft high (approximate)
- 1,300 standard cubic feet per minute (scfm) flow rate (approximate)
- 55°F exhaust gas temperature
- The stack will not be equipped with a rain cap

In order to assess the potential impacts on ambient TCE and 1,1-DCE concentrations from the project, modeling was performed using estimated maximum potential emissions based on the system's maximum TCE input of 1,000 parts per billion (ppb); information was provided from the manufacturer.

The average expected TCE concentrations in groundwater prior to treatment are 517 parts per billion (ppb) and 450 ppb for ATU 234 and ATU 235, respectively. Based on average expected TCE concentration in untreated groundwater, the TCE emissions to air are estimated as 5.167×10^{-2} pound per

⁶ Air stripper model information based on as-built equipment.

⁷ http://www.qedenv.com/products/air_s.html

⁸ Design parameters received in e-mail to Geosyntec on January 24, 2013, and January 28, 2013.

hour (lb/hr) and 4.498×10^{-2} lb/hr for ATU 234 and ATU 235, respectively. The maximum observed TCE mass concentration based on sampling data from existing extraction wells was 870 ppb.⁹ As such, 9.994×10^{-2} lb/hr based on 1,000 ppb provides a conservative basis for modeling potential emissions.

The maximum emission rates during operation for each model scenario are listed in Table B.2 in both lb/hr and g/s.

Table B.2. Estimated Emission Rates

Model ID	Scenario Description	TU 234 Mass Emissions (lb/hr)	TU 234 Mass Emissions (g/s)	Untreated Water Concentration (ppb)	TU 235 Mass Emissions (lb/hr)	TU 235 Mass Emissions (g/s)	Untreated Water Concentration (ppb)
Max_TCE	Maximum TCE	9.994×10^{-2}	1.259×10^{-2}	1,000	9.994×10^{-2}	1.259×10^{-2}	1,000
Max_1,1-DCE	Maximum 1,1-DCE ¹⁰	9.994×10^{-2}	1.259×10^{-2}	1,000	9.994×10^{-2}	1.259×10^{-2}	1,000

B.1.4.2 Maximum Off-Site Concentrations

The property boundary ambient concentration for each HAP/TAP was estimated using the air dispersion model BREEZE AERMOD Version 7.7.1.

Surface meteorology data from station number 3816 (Paducah, KY) and the nearest available upper air meteorology data from station 00013897 (Nashville, TN) were used. Dispersion analysis was performed using meteorological data from these stations for calendar years 2008, 2009, 2010, 2011, and 2012 (January 1, 2008, through December 31, 2012). The AERMOD-ready meteorological files were purchased from Trinity Consultants, Inc.

The air dispersion modeling analysis was performed using the pollutant-specific controlled emission rates discussed in Section B.1.4.1 to estimate the off-site concentration for each pollutant.

The results of the air dispersion modeling analysis suggest that the maximum annual concentration occurs at a receptor (341114.10, 4109112.90) along the property boundary northeast of the proposed stack locations, illustrated in Figure B.2.

⁹ Sampling data received in e-mail to Geosyntec on January 24, 2013. See May 8, 2013, e-mail to Todd Mullins, Kentucky Department for Environmental Protection, from Stan Knaus, LATA Environmental Services of Kentucky, LLC.

¹⁰ 1,1-DCE is a volatile similar to TCE; therefore, mass emission rates of 1,1-DCE conservatively were assumed to equal TCE.

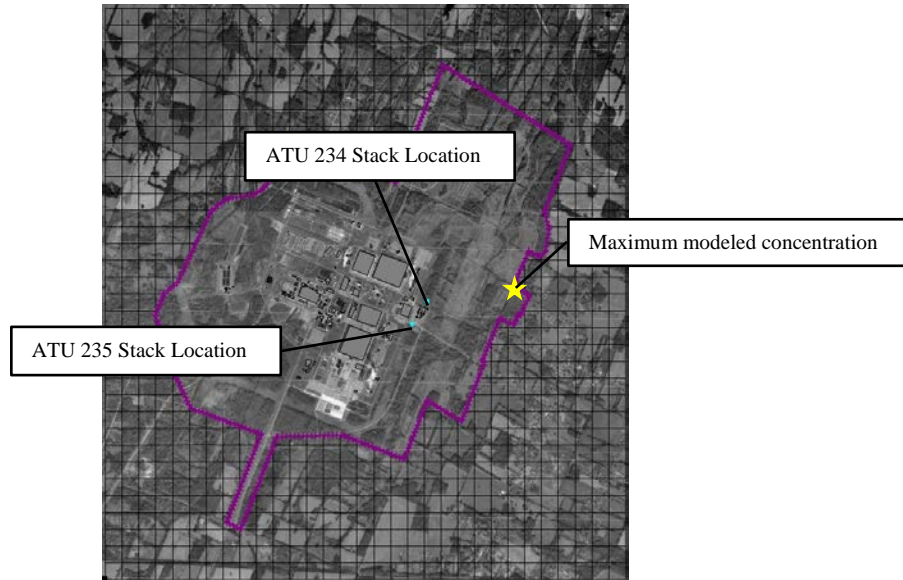

Figure B.2. Modeling Results

The estimated off-site pollutant concentrations for each modeling scenario are shown in Table B.3.

Table B.3. Estimated Off-site Concentrations

Model ID	Off-Site Concentration Limit (µg/m³)	Annual Off-site Concentration (µg/m³)	Below Limit? (Yes/No)
Max_TCE	0.43	0.084	Yes
Max_1,1-DCE	210	0.084	Yes

The results of these air dispersion modeling analyses show the estimated maximum annual average concentration for both modeling scenarios will be below the corresponding maximum allowable off-site concentrations of respective pollutants. Additionally, the allowable off-site concentration limit for TCE was developed using a lifetime (i.e., 70-year exposure period) per EPA’s RSL User’s Guide.¹¹ The duration of potential exposure associated with the operation of the TUs will be less than 70 years. Therefore, emissions associated with this project are not expected to be harmful to the health and welfare of humans, animals, or plants.

¹¹ http://www.epa.gov/reg3hwmd/risk/human/rb-concentration_table/usersguide.htm

THIS PAGE INTENTIONALLY LEFT BLANK

CD

AIR DISPERSION ANALYSIS

THIS PAGE INTENTIONALLY LEFT BLANK

APPENDIX C
NORTHEAST PLUME EXTRACTION SYSTEM
DESIGN AND EVALUATION

THIS PAGE INTENTIONALLY LEFT BLANK

NE Plume Extraction System Design and Evaluation

July 26, 2012

Outline

- Model Re-Calibration
- Evaluation of NW Plume Extraction System Using Updated Model
- Design and Evaluation of NE Plume Extraction System

Model-Recalibration

Recalibration

- Calibrated 3 model variants
 - NW Plume centroid migrated eastward with time, KRCEE lithologic pilot point constraints
 - NW Plume centroid remained constant, KRCEE lithologic pilot point constraints
 - NW Plume centroid remained constant, didn't use KRCEE lithologic pilot point constraints
- Model consists of 7 steady-state stress periods and 10 transient stress periods

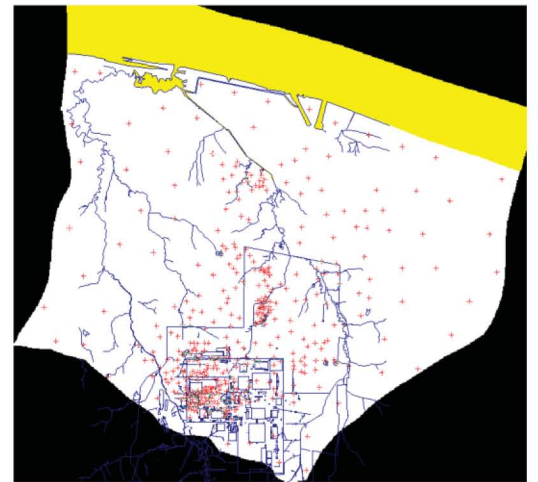
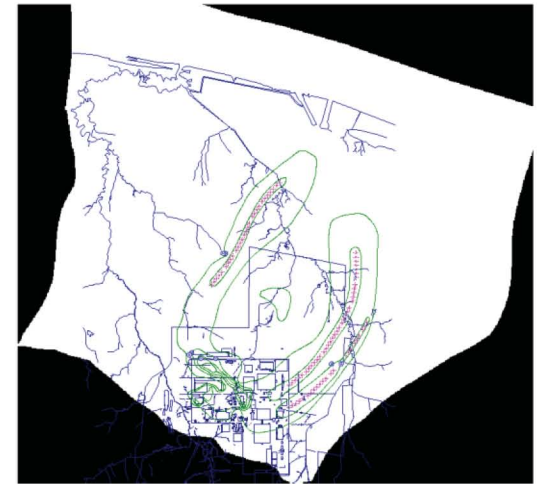

Stress Period Setup

Collection Period	Stress Period Number	Stress Period Type	Stress Period Length, days	Cumulative Time, days	Number of Targets	Target Type	Ohio River Stage, ft msl
February 1995	1	Steady-State	1	1	76	Head, Trajectory, Flux	297.4
3 rd Quarter 2005	2	Steady-State	1	2	110	Head, Trajectory, Flux	301.3
1 st Quarter 2007	3	Steady-State	1	3	110	Head, Trajectory, Flux	313.0
April 2010	4	Steady-State	1	4	38	Head, Trajectory, Flux	327.2
October 11, 2010	5	Steady-State	1	5	13	Head, Trajectory, Flux	294.8
October 12, 2010	6	Transient	1	6	13	Drawdown, Flux	295.5
October 13, 2010	7	Transient	1	7	13	Drawdown, Flux	295.5
October 14, 2010	8	Transient	1	8	13	Drawdown, Flux	294.9
October 15, 2010	9	Transient	1	9	13	Drawdown, Flux	294.5
October 16, 2010	10	Transient	1	10	13	Drawdown, Flux	294.3
October 17, 2010	11	Transient	1	11	13	Drawdown, Flux	293.8
October 18, 2010	12	Transient	1	12	13	Drawdown, Flux	293.5
October 19, 2010	13	Transient	1	13	13	Drawdown, Flux	293.1
October 20, 2010	14	Transient	1	14	13	Drawdown, Flux	292.8
October 21, 2010	15	Transient	1	15	13	Drawdown, Flux	292.7
April 2011	16	Steady-State	1	16	212	Head, Trajectory, Flux	320.6
October 2011	17	Steady-State	1	17	202	Head, Trajectory, Flux	292.5

C-7

Recalibration

- Outcome
 - Hydraulic conductivity field that is "**best**" for the 7 steady-state and 10 transient stress periods
 - **7 unique recharge regimes** corresponding to the 7 steady-state stress periods
 - The 10 transient stress periods use the same recharge distribution as stress period 5

Model-Predicted Ambient Particle Traces

C-9

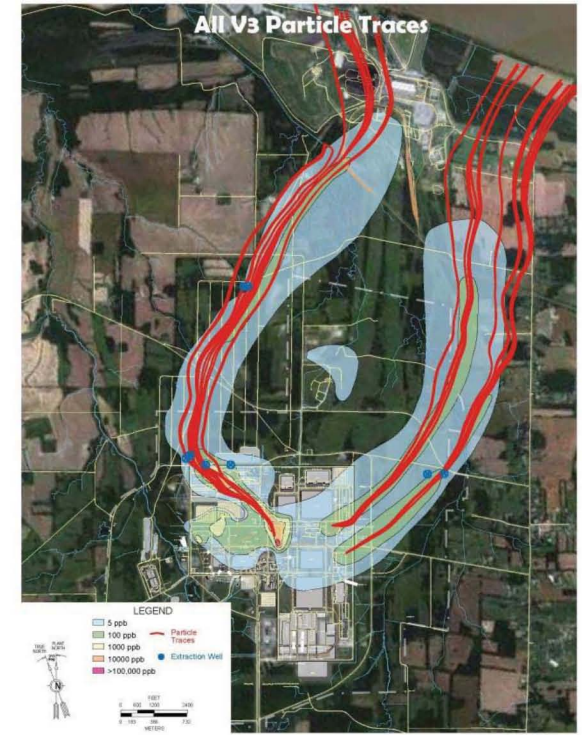
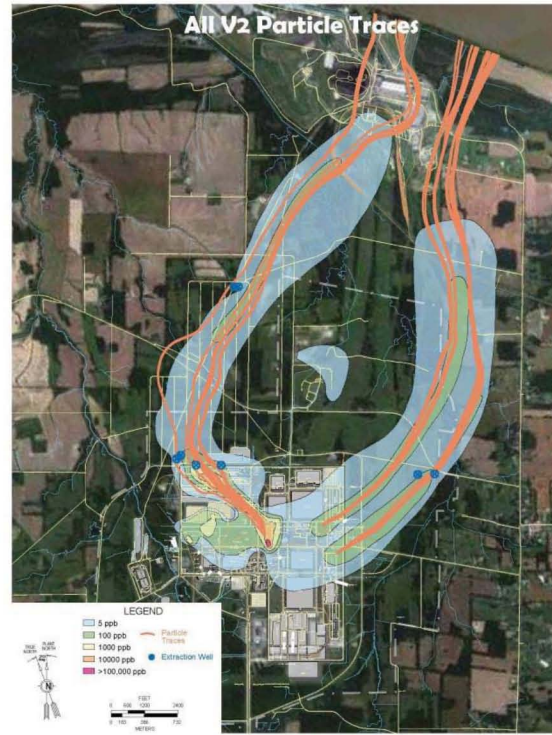
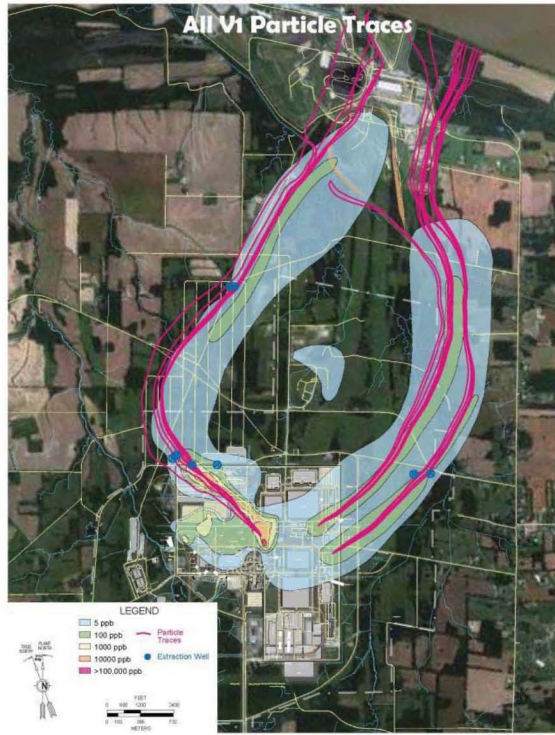

↑
"Best"

Calibration Results – Layer 1 Hydraulic Conductivity

C-10

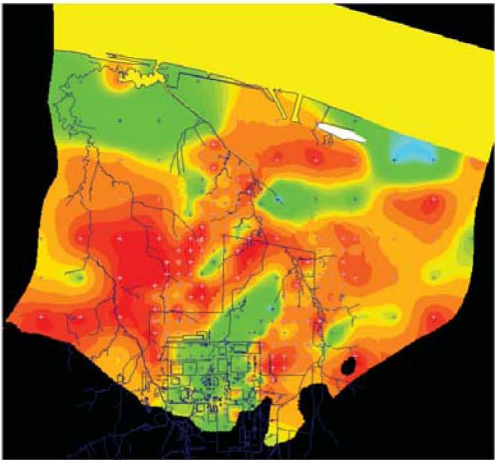

2008

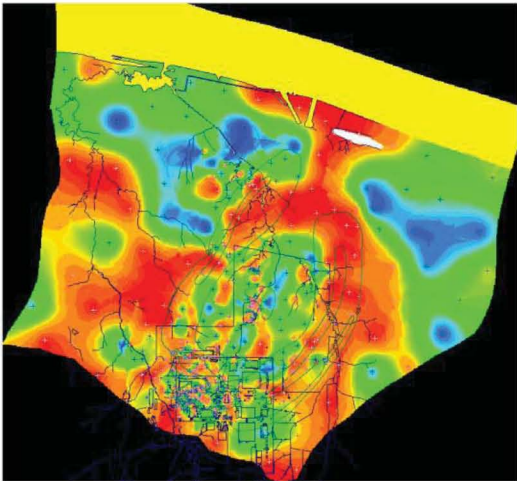

V1

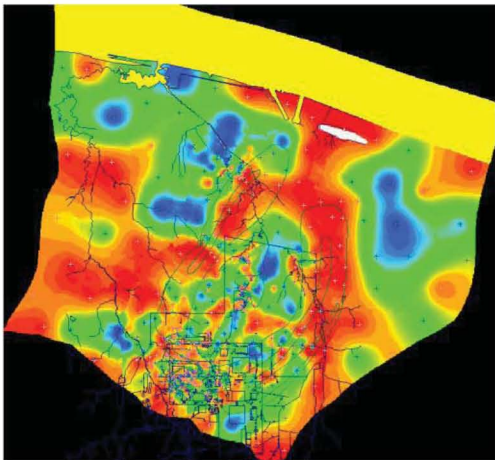

V2

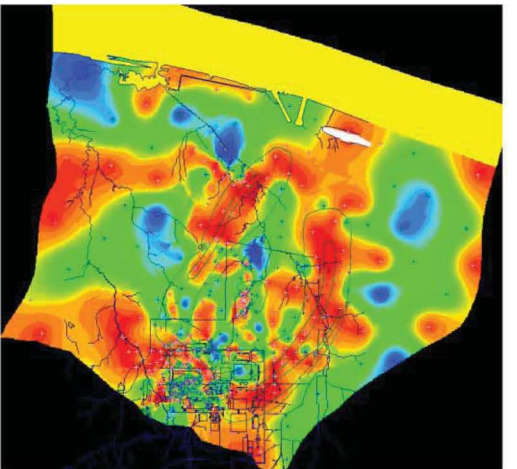

V3

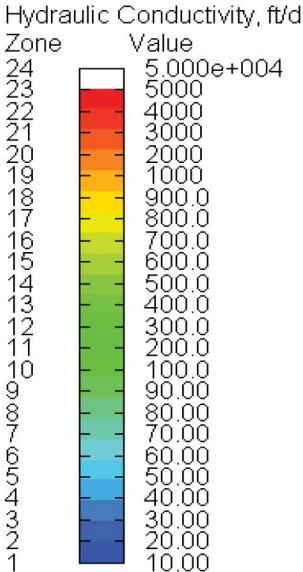

Model Predicted Anthropogenic Recharge

C-11

Date	Anthropogenic Recharge, gpm		
	V1	V2	V3
Feb 1995	884	1,152	1,442
3Q 2005	1,204	1,337	1,525
1Q 2007	931	1,042	1,048
April 2010	1,065	678	978
Oct 2010	977	1,317	1,725
April 2011	831	599	491
Oct 2011	1,148	1,420	1,758
Mean	1,006	1,078	1,281
Median	977	1,152	1,442

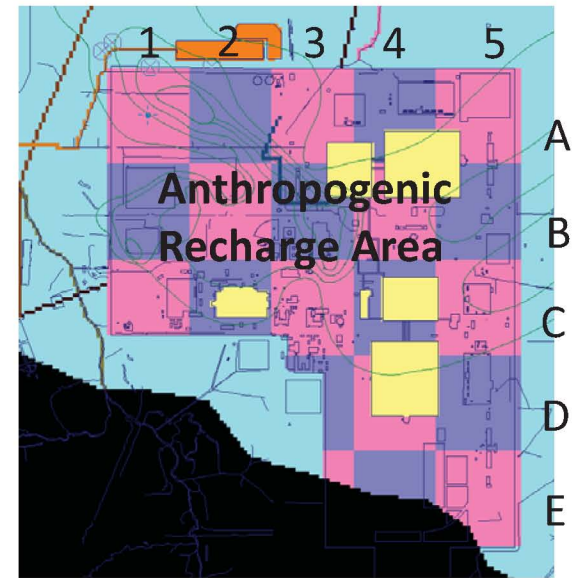

Evaluation of NW Plume Extraction System Using Updated Model

Evaluation of NW Plume Extraction System Using Updated Model

- Perform evaluation to characterize performance of the system under “new” model recharge and hydraulic conductivity regimes
- Are system adjustments required?

Model Variant 2 NW Plume Extraction System Capture Zone Evaluation

C-14

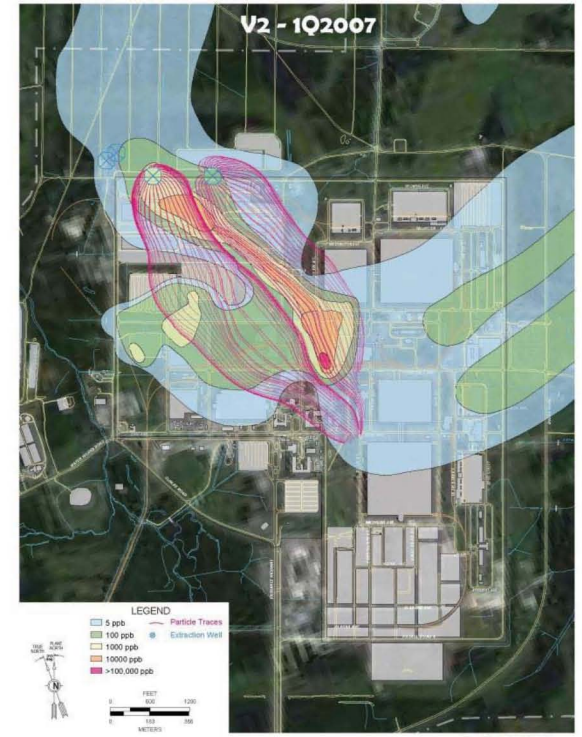
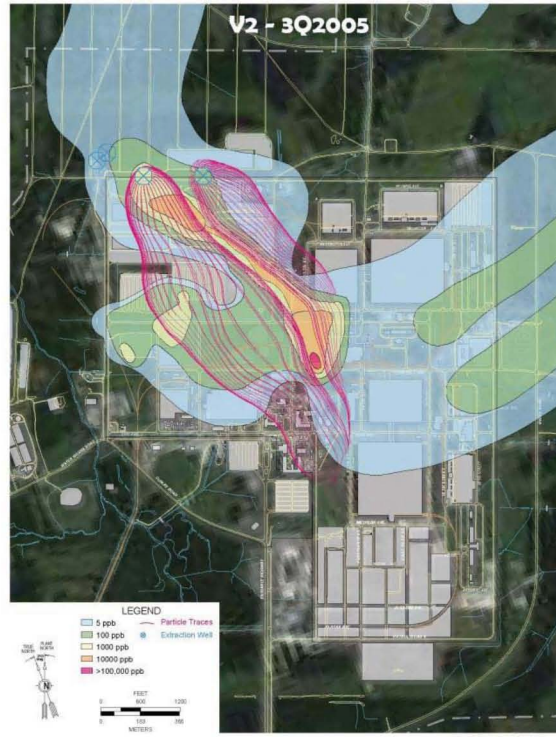
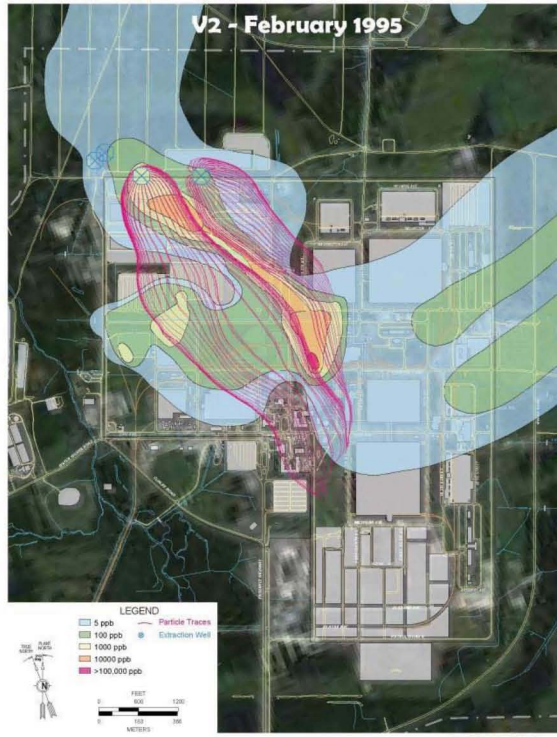

Date	Anthropogenic Recharge, gpm		
	V1	V2	V3
Feb 1995	884	1,152	1,442
3Q 2005	1,204	1,337	1,525
1Q 2007	931	1,042	1,048
April 2010	1,065	678	978
Oct 2010	977	1,317	1,725
April 2011	831	599	491
Oct 2011	1,148	1,420	1,758
Mean	1,006	1,078	1,281
Median	977	1,152	1,442

Model Variant 2 NW Plume Extraction System Capture Zone Evaluation

C-15

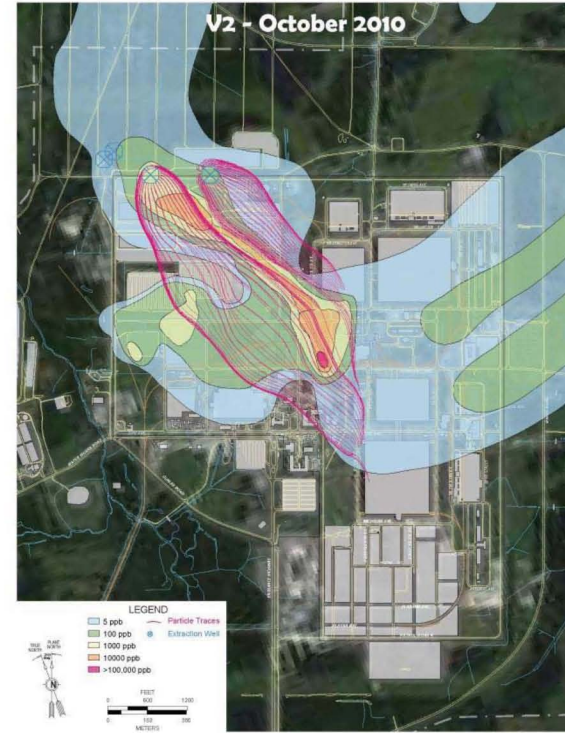
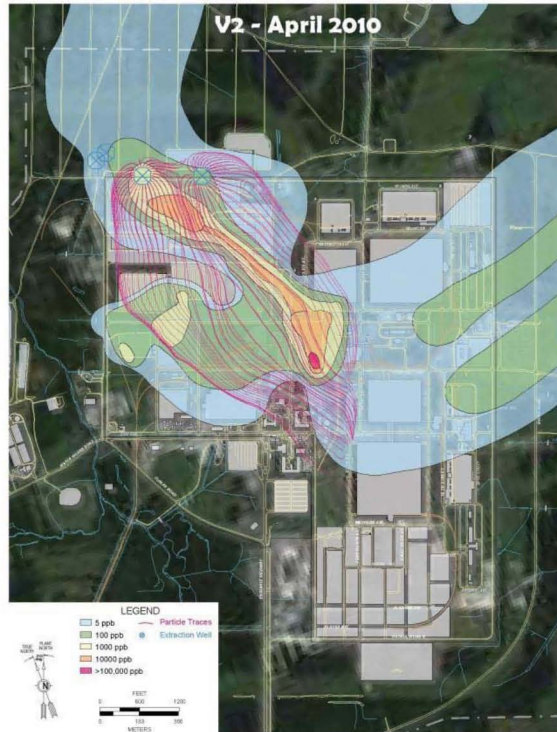

Date	Anthropogenic Recharge, gpm		
	V1	V2	V3
Feb 1995	884	1,152	1,442
3Q 2005	1,204	1,337	1,525
1Q 2007	931	1,042	1,048
April 2010	1,065	678	978
Oct 2010	977	1,317	1,725
April 2011	831	599	491
Oct 2011	1,148	1,420	1,758
Mean	1,006	1,078	1,281
Median	977	1,152	1,442

Model Variant 2 NW Plume Extraction System Capture Zone Evaluation

C-16

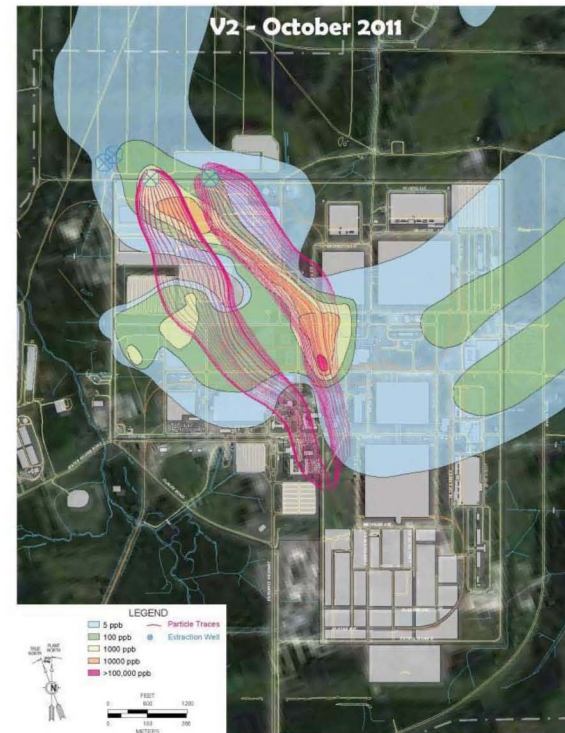
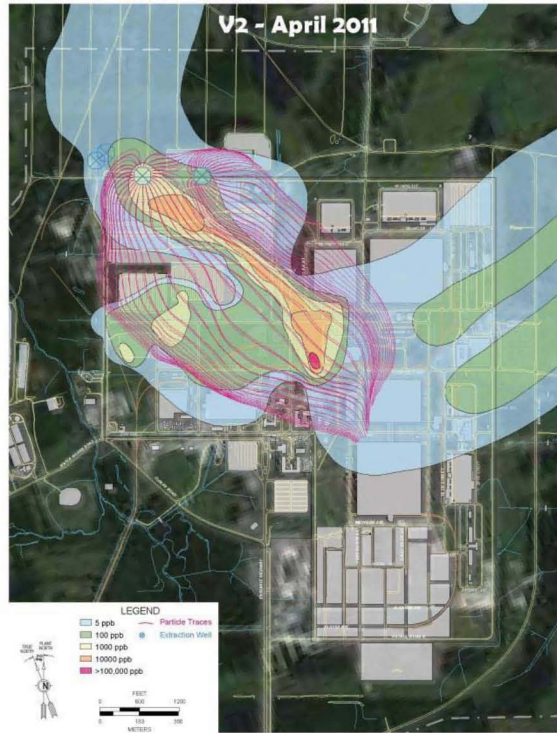

Date	Anthropogenic Recharge, gpm		
	V1	V2	V3
Feb 1995	884	1,152	1,442
3Q 2005	1,204	1,337	1,525
1Q 2007	931	1,042	1,048
April 2010	1,065	678	978
Oct 2010	977	1,317	1,725
April 2011	831	599	491
Oct 2011	1,148	1,420	1,758
Mean	1,006	1,078	1,281
Median	977	1,152	1,442

New NW Plume Extraction Well Capture Zone Evaluation Summary

- Capture zone width and orientation is a function of the volume and location of anthropogenic recharge
- Each of the 7 modeled periods represents a snap shot in time of anthropogenic recharge conditions
- Reality is anthropogenic recharge is constantly changing between these realizations and possibly beyond the simulated values
- There is no way to know which of the anthropogenic recharge scenarios is dominant
- **The challenge is to design a robust extraction system that accounts for anthropogenic recharge variability**

EW 232 Capture at 220 gpm

C-18

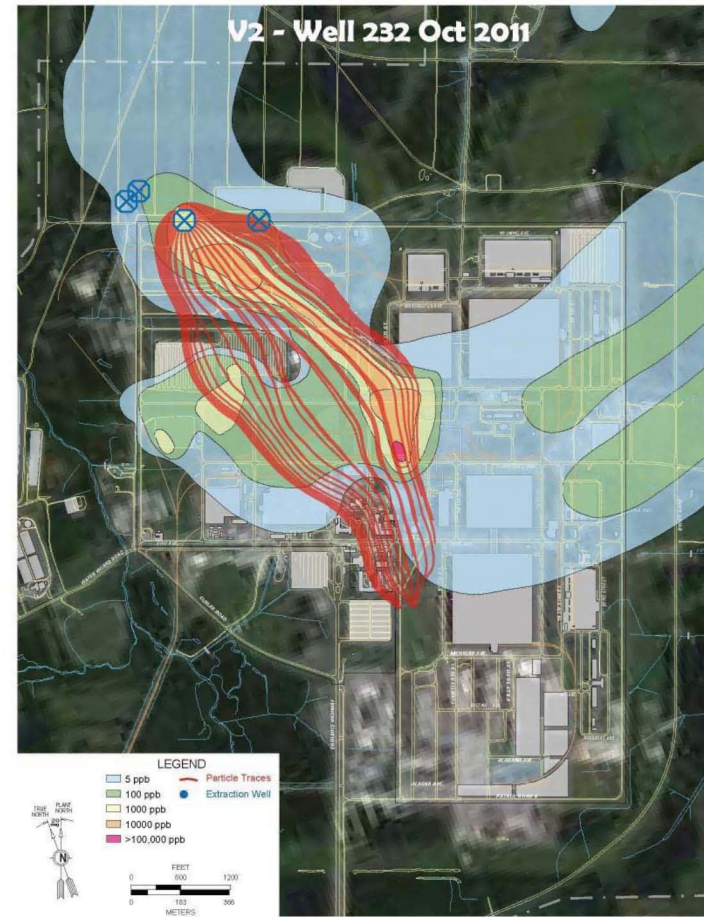
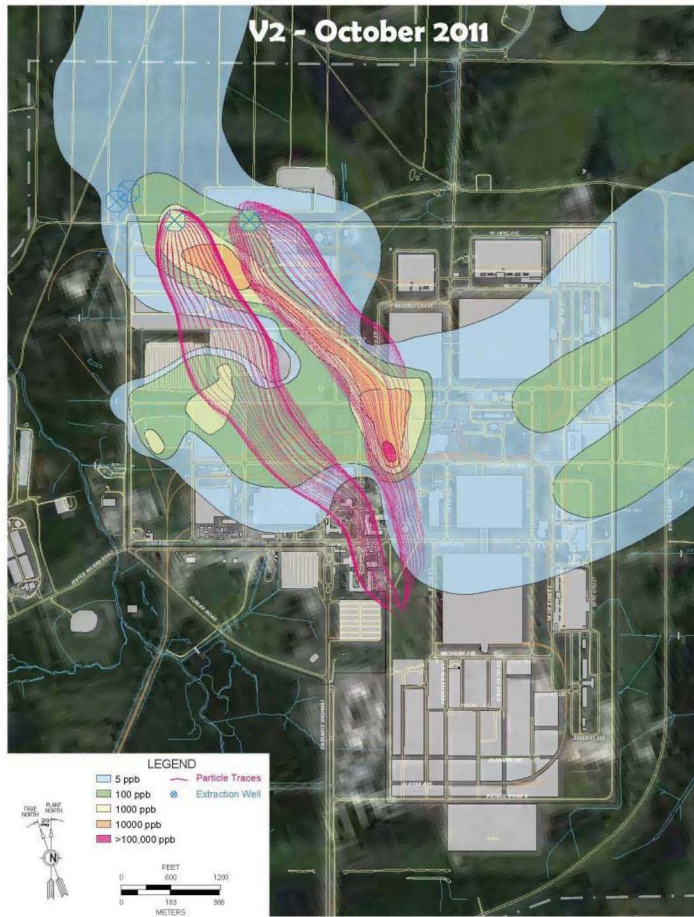

EW 233 Capture at 220 gpm

C-19

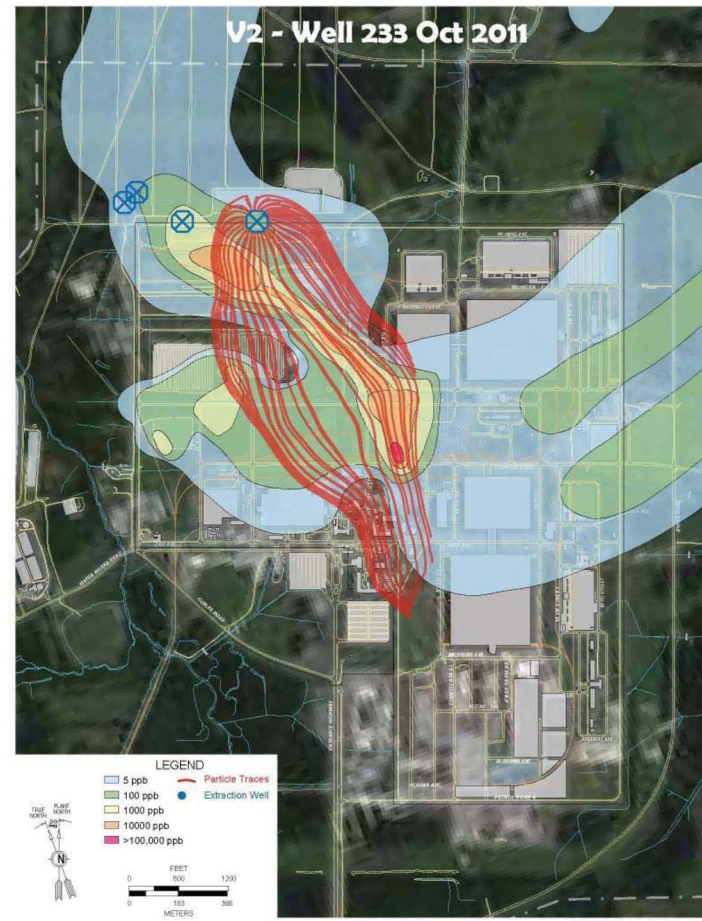
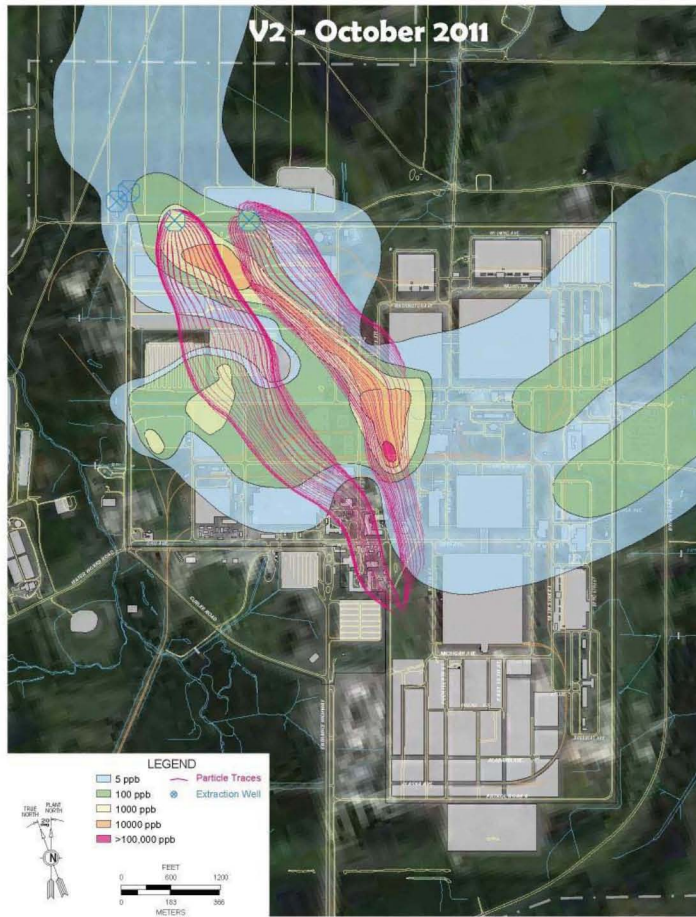

Model Variant 2 NW Plume Extraction System Capture Zone Evaluation

- Operate individually either EW232 or EW233 at 220 gpm
- Individual capture zones envelope C400, the primary source of NW Plume dissolved contamination
- NE Plume designs will assume either EW232 or EW233 will be operational, but not both
- 220 gpm is the Current Treatment Capacity

Design and Evaluation of NE Plume Extraction System

NE Plume Extraction System Design Constraints

- Minimize trajectory impacts at C400
- Complement NW Extraction Well capture zones
- Avoid potential CERCLA Cell locations
- Manage anthropogenic recharge variability
- Design for both anthropogenic and no anthropogenic recharge conditions to the extent possible (PGDP vs Post-PGDP)

NOTE: There is uncertainty associated with Post-PGDP conditions

Potential CERCLA Cell Locations

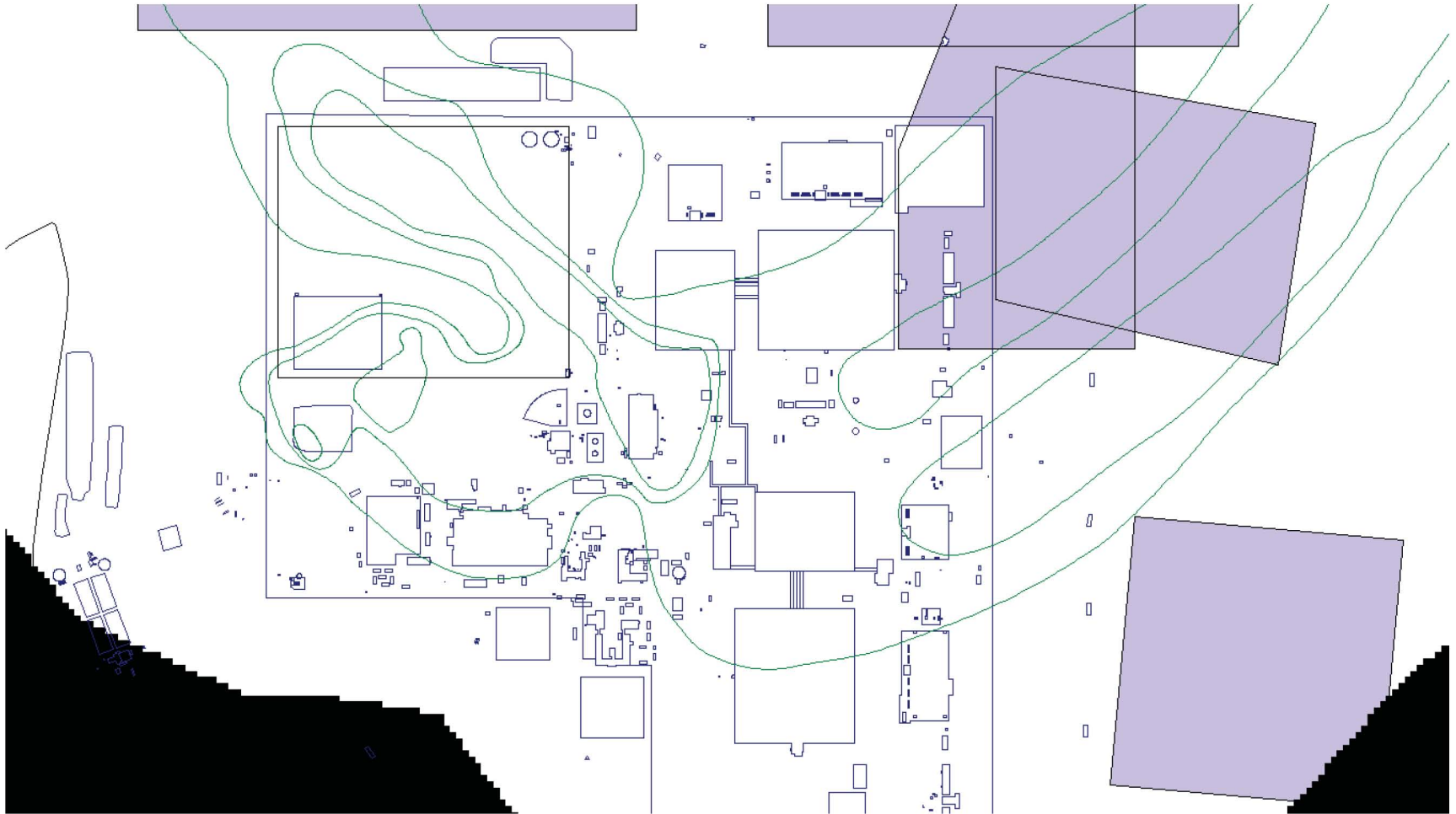

C-23

 Potential CERCLA Cell Locations

Maintain NW Plume Trajectory

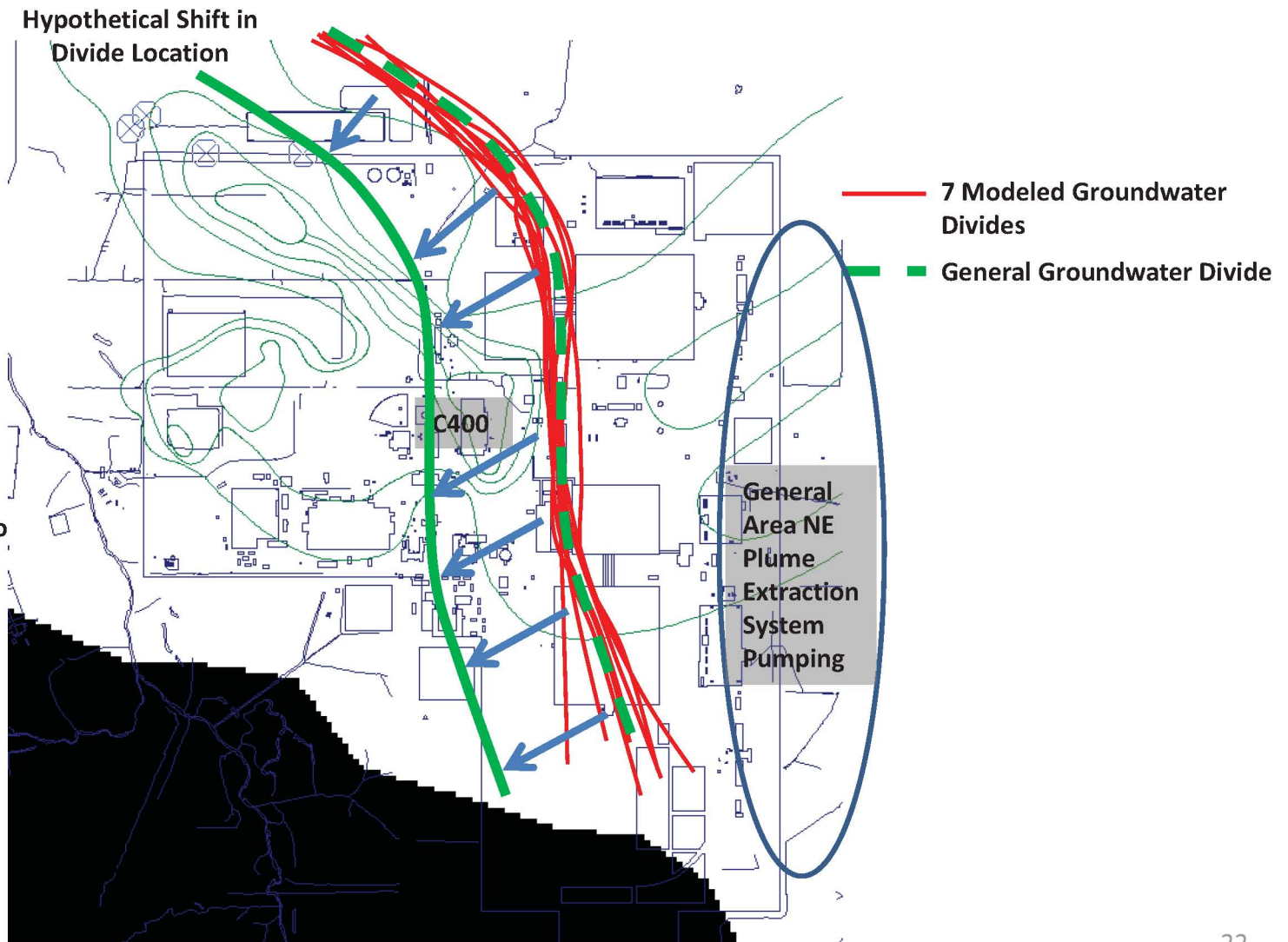

Do not want to shift the divide location westward in response to pumping

Doing so will cause higher concentration portions of the plume to flow eastward and contaminate lower concentration portions of the RGA

C-24

Design and Evaluation of NE Plume Extraction System

- Use Version 2 Calibrated Model, October 2011 Recharge Regime for Design and Evaluation
- October 2011 Represents Maximum Anthropogenic Recharge
- Use *Brute Force* Particle Tracking Optimization Algorithm, Same as was Used for NW Plume Extraction System Design

Design and Evaluation of NE Plume Extraction System

- After Developing a NE Plume Well Field Configuration and Pumping Schedule Using Maximum Anthropogenic Recharge Conditions, Evaluate the Design using Minimum and Average Anthropogenic Recharge Regimes and Post-PGDP Recharge Regimes
- **NOTE:** Dozens of Extraction Well Configurations Were Evaluated, Only a Few Relevant Designs Will Be Presented Today

NE Extraction Wells Along Fence Line

Candidate Well Locations

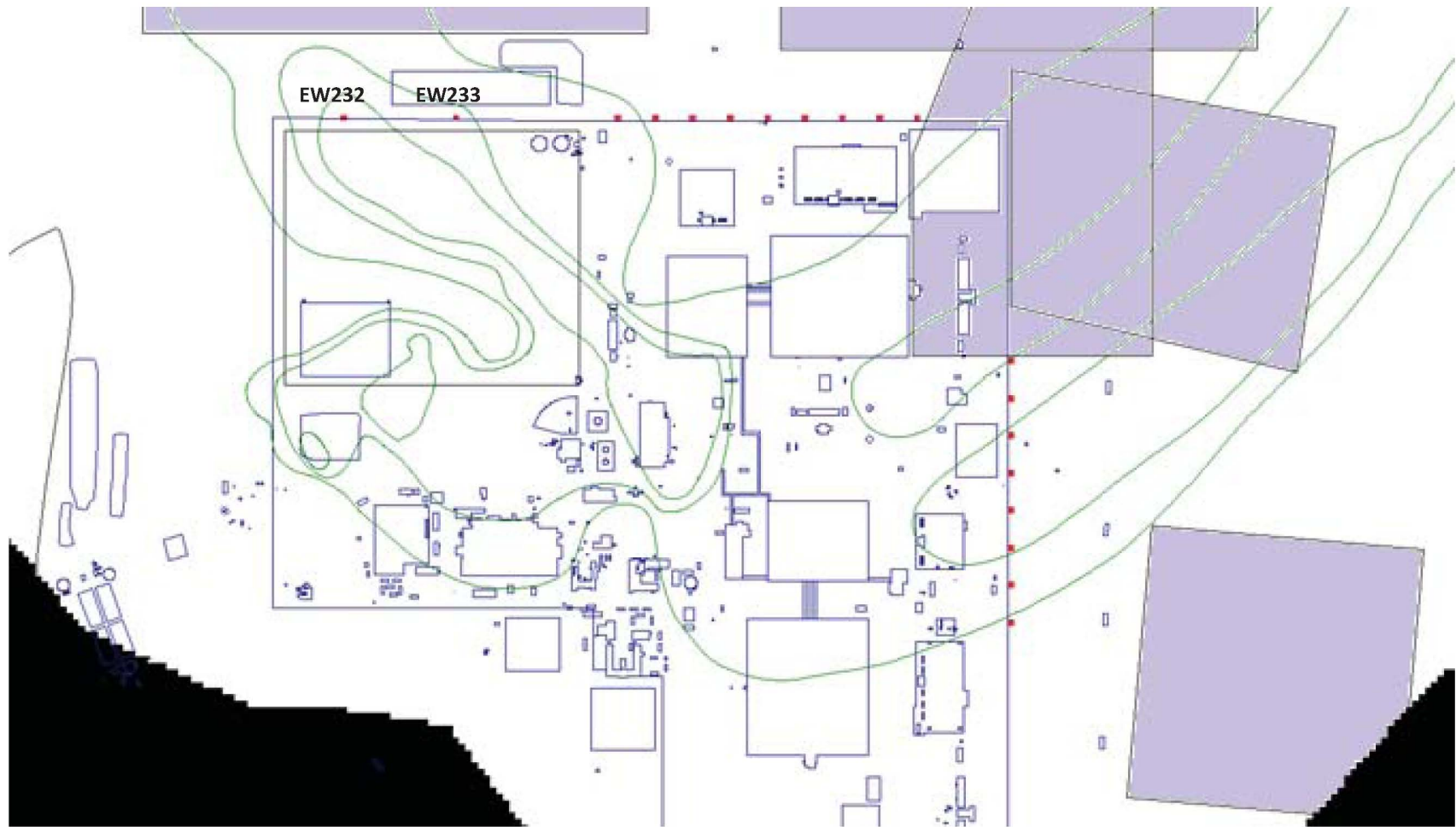

■ Proposed CERCLA Cell Locations ■ Candidate Well Locations

C-28

Particles Representing Dissolved Mass



NE Extraction System Design and Evaluation

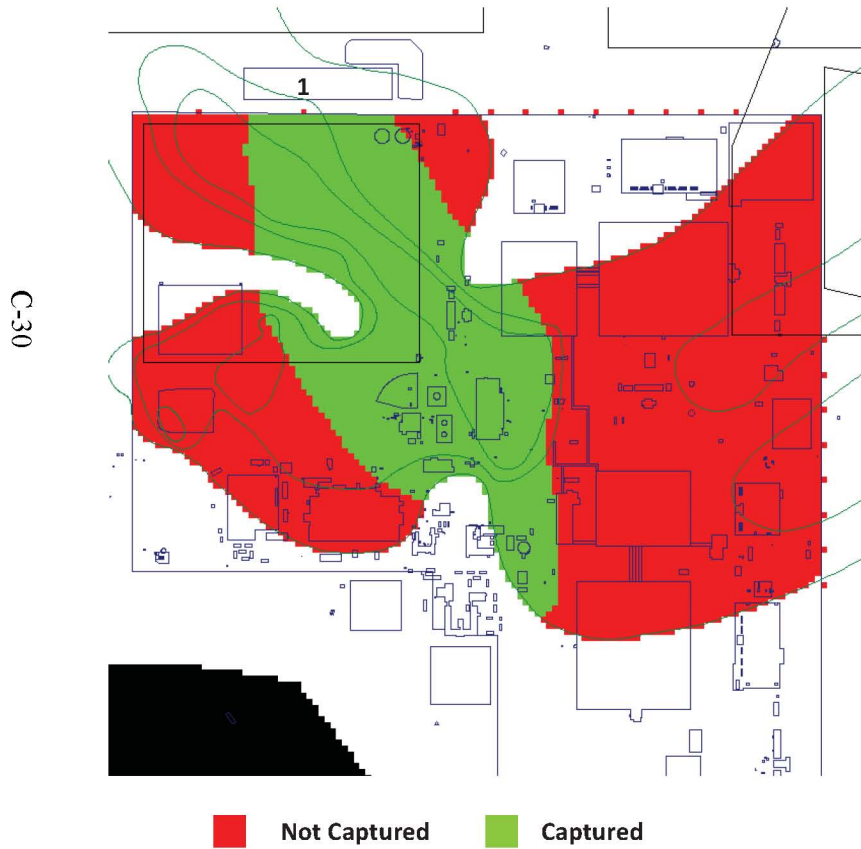

Well	Pumping Rate, gpm						
	Iteration						
	1	2	3	4	5	6	7
1	220	220	220	220	220	220	220
2		250	250	250	250	250	250
3			250	250	250	250	250
4				250	250	250	250
5					250	250	250
6						250	250
7							250
TOTAL	220	470	720	970	1,220	1,470	1,720

Well	Mass Captured						
	Iteration						
	1	2	3	4	5	6	7
1	88.2%	83.4%	51.4%	32.4%	29.0%	27.3%	24.6%
2		0.4%	0.4%	0.4%	0.4%	0.4%	0.4%
3			42.2%	5.9%	0.9%	0.5%	0.5%
4				44.9%	42.3%	32.9%	30.1%
5					20.7%	0.3%	0.5%
6						37.9%	43.7%
7							0.2%
TOTAL	88.2%	83.8%	94.0%	83.6%	93.3%	99.3%	99.9%

NE Extraction System Design and Evaluation

C-31

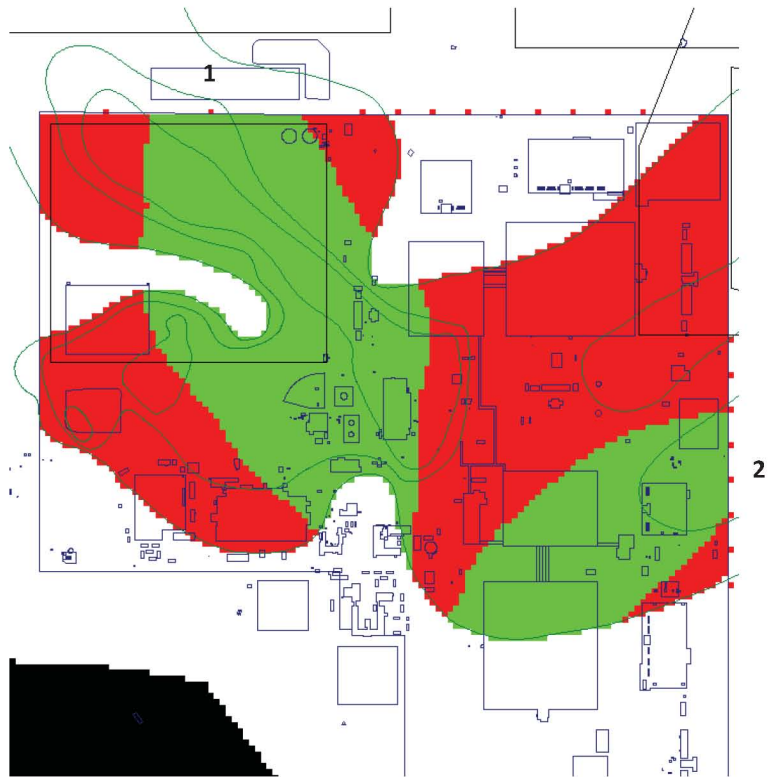

■ Not Captured ■ Captured

Pumping Rate, gpm

Well	Iteration						
	1	2	3	4	5	6	7
1	220	220	220	220	220	220	220
2		250	250	250	250	250	250
3			250	250	250	250	250
4				250	250	250	250
5					250	250	250
6						250	250
7							250
TOTAL	220	470	720	970	1,220	1,470	1,720

Mass Captured

Well	Iteration						
	1	2	3	4	5	6	7
1	88.2%	83.4%	51.4%	32.4%	29.0%	27.3%	24.6%
2		0.4%	0.4%	0.4%	0.4%	0.4%	0.4%
3			42.2%	5.9%	0.9%	0.5%	0.5%
4				44.9%	42.3%	32.9%	30.1%
5					20.7%	0.3%	0.5%
6						37.9%	43.7%
7							0.2%
TOTAL	88.2%	83.8%	94.0%	83.6%	93.3%	99.3%	99.9%

NE Extraction System Design and Evaluation

C-32

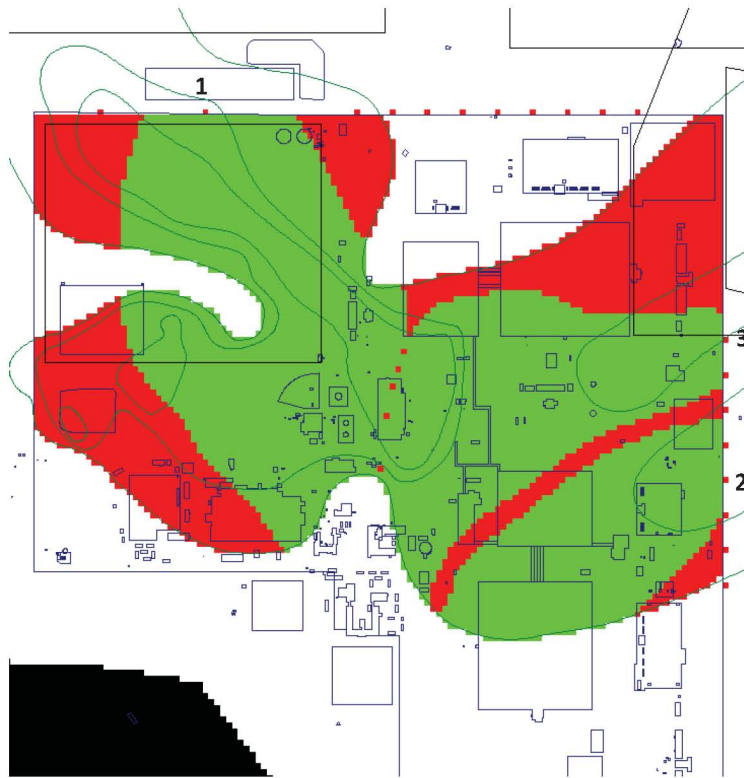

■ Not Captured ■ Captured

Pumping Rate, gpm

Well	Iteration						
	1	2	3	4	5	6	7
1	220	220	220	220	220	220	220
2		250	250	250	250	250	250
3			250	250	250	250	250
4				250	250	250	250
5					250	250	250
6						250	250
7							250
TOTAL	220	470	720	970	1,220	1,470	1,720

Mass Captured

Well	Iteration						
	1	2	3	4	5	6	7
1	88.2%	83.4%	51.4%	32.4%	29.0%	27.3%	24.6%
2		0.4%	0.4%	0.4%	0.4%	0.4%	0.4%
3			42.2%	5.9%	0.9%	0.5%	0.5%
4				44.9%	42.3%	32.9%	30.1%
5					20.7%	0.3%	0.5%
6						37.9%	43.7%
7							0.2%
TOTAL	88.2%	83.8%	94.0%	83.6%	93.3%	99.3%	99.9%

Violated Design Tenant: Maintain NW Plume Trajectory

NE Extraction System Design and Evaluation

C-33

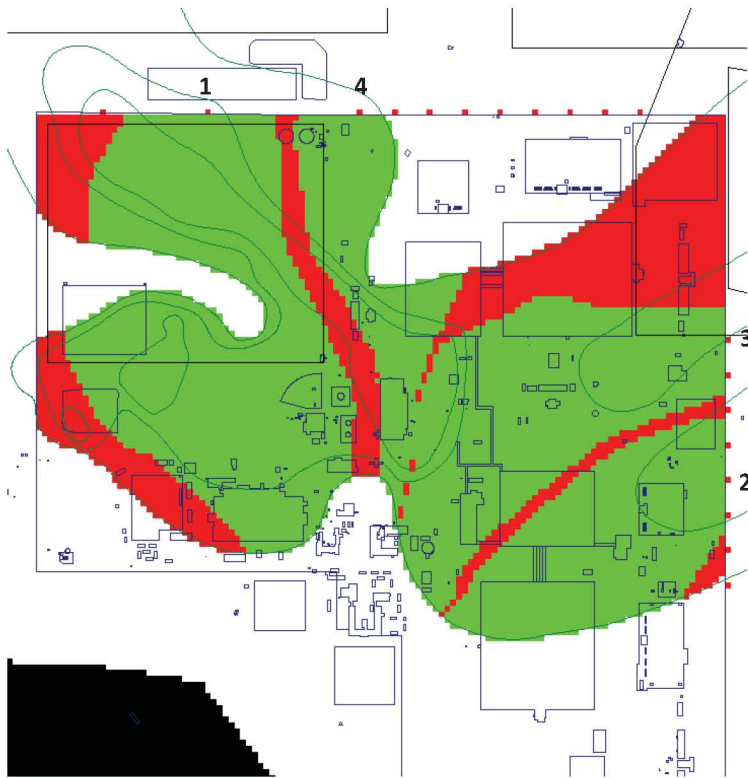

■ Not Captured ■ Captured

Pumping Rate, gpm

Well	Iteration						
	1	2	3	4	5	6	7
1	220	220	220	220	220	220	220
2		250	250	250	250	250	250
3			250	250	250	250	250
4				250	250	250	250
5					250	250	250
6						250	250
7							250
TOTAL	220	470	720	970	1,220	1,470	1,720

Mass Captured

Well	Iteration						
	1	2	3	4	5	6	7
1	88.2%	83.4%	51.4%	32.4%	29.0%	27.3%	24.6%
2		0.4%	0.4%	0.4%	0.4%	0.4%	0.4%
3			42.2%	5.9%	0.9%	0.5%	0.5%
4				44.9%	42.3%	32.9%	30.1%
5					20.7%	0.3%	0.5%
6						37.9%	43.7%
7							0.2%
TOTAL	88.2%	83.8%	94.0%	83.6%	93.3%	99.3%	99.9%

NE Extraction System Design and Evaluation

C-34

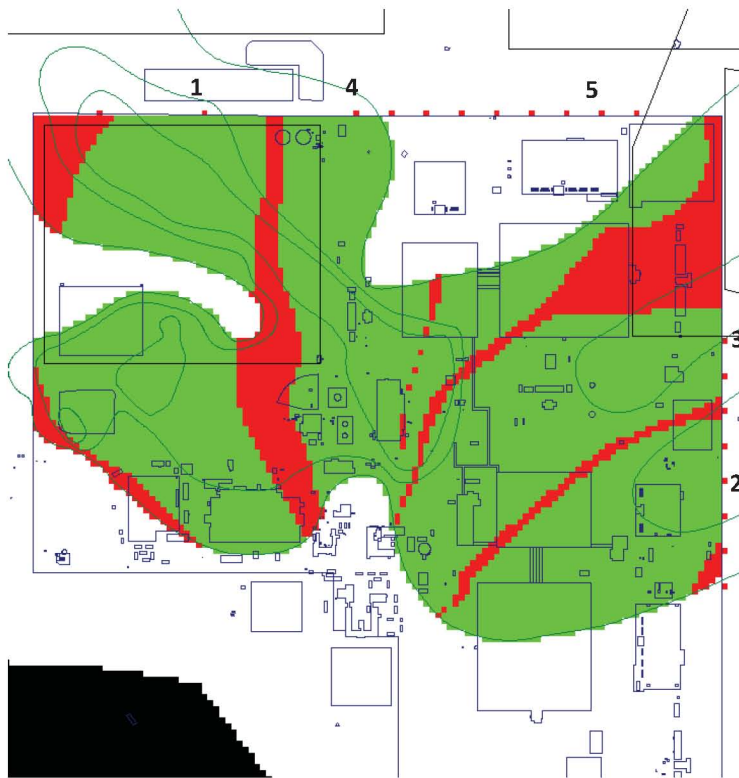

■ Not Captured ■ Captured

Pumping Rate, gpm

Well	Iteration						
	1	2	3	4	5	6	7
1	220	220	220	220	220	220	220
2		250	250	250	250	250	250
3			250	250	250	250	250
4				250	250	250	250
5					250	250	250
6						250	250
7							250
TOTAL	220	470	720	970	1,220	1,470	1,720

Mass Captured

Well	Iteration						
	1	2	3	4	5	6	7
1	88.2%	83.4%	51.4%	32.4%	29.0%	27.3%	24.6%
2		0.4%	0.4%	0.4%	0.4%	0.4%	0.4%
3			42.2%	5.9%	0.9%	0.5%	0.5%
4				44.9%	42.3%	32.9%	30.1%
5					20.7%	0.3%	0.5%
6						37.9%	43.7%
7							0.2%
TOTAL	88.2%	83.8%	94.0%	83.6%	93.3%	99.3%	99.9%

NE Extraction System Design and Evaluation



Well	Pumping Rate, gpm						
	Iteration						
	1	2	3	4	5	6	7
1	220	220	220	220	220	220	220
2		250	250	250	250	250	250
3			250	250	250	250	250
4				250	250	250	250
5					250	250	250
6						250	250
7							250
TOTAL	220	470	720	970	1,220	1,470	1,720

Well	Mass Captured						
	Iteration						
	1	2	3	4	5	6	7
1	88.2%	83.4%	51.4%	32.4%	29.0%	27.3%	24.6%
2		0.4%	0.4%	0.4%	0.4%	0.4%	0.4%
3			42.2%	5.9%	0.9%	0.5%	0.5%
4				44.9%	42.3%	32.9%	30.1%
5					20.7%	0.3%	0.5%
6						37.9%	43.7%
7							0.2%
TOTAL	88.2%	83.8%	94.0%	83.6%	93.3%	99.3%	99.9%

NE Extraction System Design and Evaluation



Well	Pumping Rate, gpm						
	Iteration						
	1	2	3	4	5	6	7
1	220	220	220	220	220	220	220
2		250	250	250	250	250	250
3			250	250	250	250	250
4				250	250	250	250
5					250	250	250
6						250	250
7							250
TOTAL	220	470	720	970	1,220	1,470	1,720

Well	Mass Captured						
	Iteration						
	1	2	3	4	5	6	7
1	88.2%	83.4%	51.4%	32.4%	29.0%	27.3%	24.6%
2		0.4%	0.4%	0.4%	0.4%	0.4%	0.4%
3			42.2%	5.9%	0.9%	0.5%	0.5%
4				44.9%	42.3%	32.9%	30.1%
5					20.7%	0.3%	0.5%
6						37.9%	43.7%
7							0.2%
TOTAL	88.2%	83.8%	94.0%	83.6%	93.3%	99.3%	99.9%

Summary NE Extraction Wells Along Fence Line

- Issues:
 - **Change NW Plume Trajectory**
 - Lots of Wells
 - High Extraction Rates
- Challenges:
 - How to keep from spreading dissolved contamination?

C400 Extraction Well Coupled with NE Extraction Wells Along Fence Line

NE Extraction System Design and Evaluation

- Is an Extraction Well Located at C400 Capable of “Pinning” Contamination at That Location?
- In Other Words, Will Use of a C400 Extraction Well Halt Unintended Spreading of Dissolved Contamination?
- How Much Should the Extraction Well be Pumped And Where Should It be Located?

C400 Mass Capture Performance

C-40

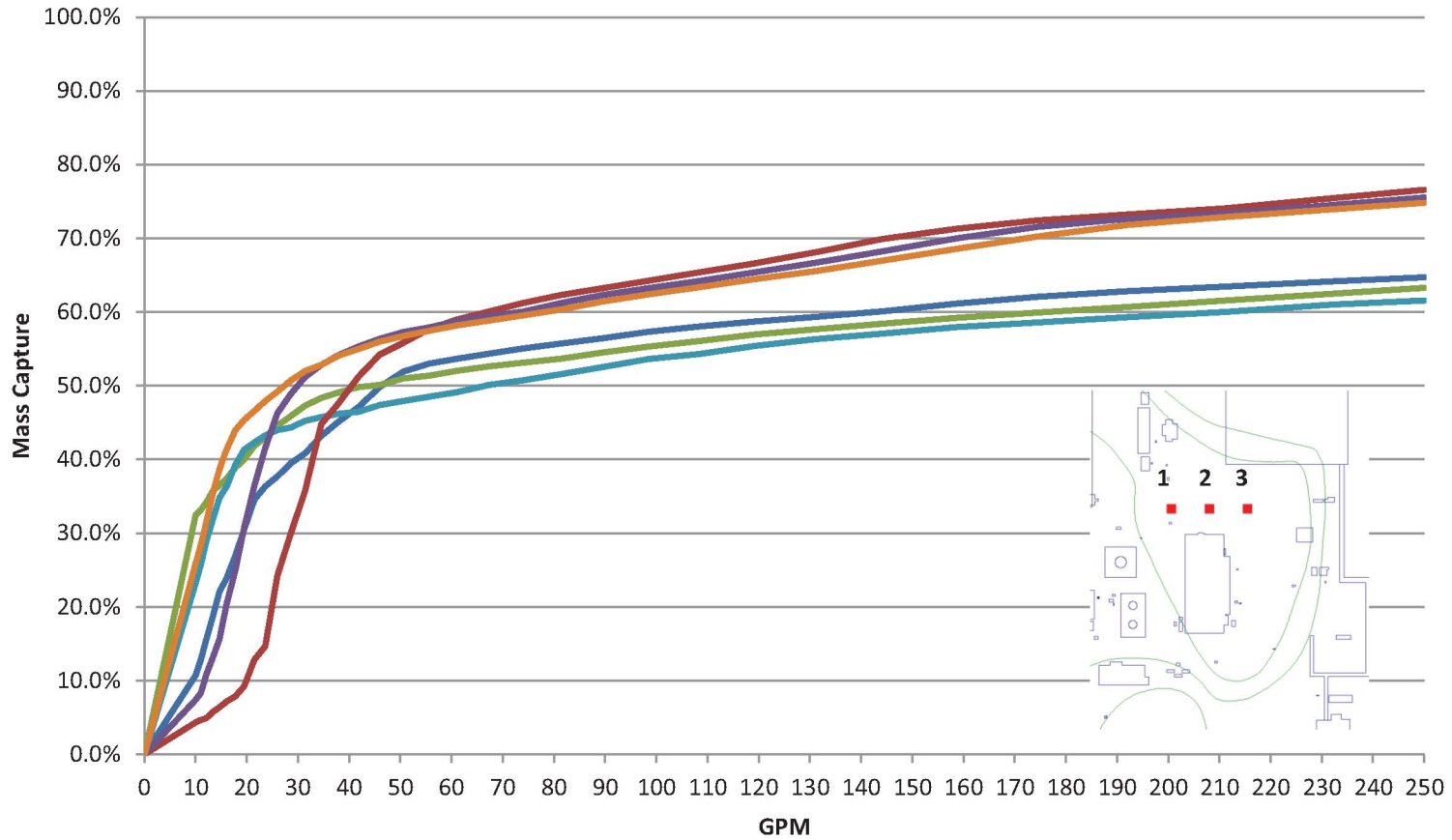

October 2011

- Well 1 - PGDP Well 2 - PGDP Well 3 - PGDP
- Well 1 - Post-PGDP Well 2 - Post-PGDP Well 3 - Post-PGDP

NE Extraction System Design and Evaluation

- After 60 gpm There isn't Much Difference in Mass Capture Performance Between the Three C400 Extraction Well Locations
- Evaluate Designs Which Have the C400 Extraction Well Operating at 80 gpm Because That is the Existing Treatment Capability

C-41

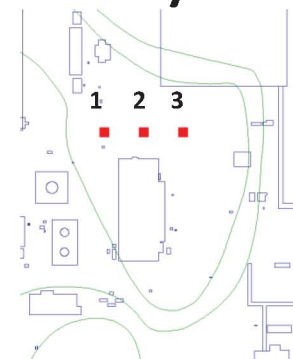

PGDP

Four Extraction Wells

EW233, C400 and 2 NE Extraction
Wells at NE Plume Lobes

NE Extraction System Design and Evaluation

- Locate NE Plume Extraction Wells Immediately Down Gradient of the Higher Concentration Lobes
- Evaluate Mass Capture Performance for 50, 100, 150, 200 and 250 gpm/Well Rates

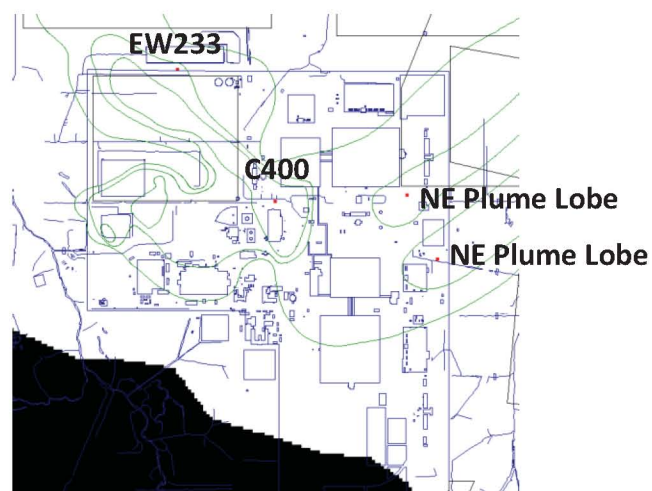

C400 Extraction Well Evaluation : PGDP

C-44

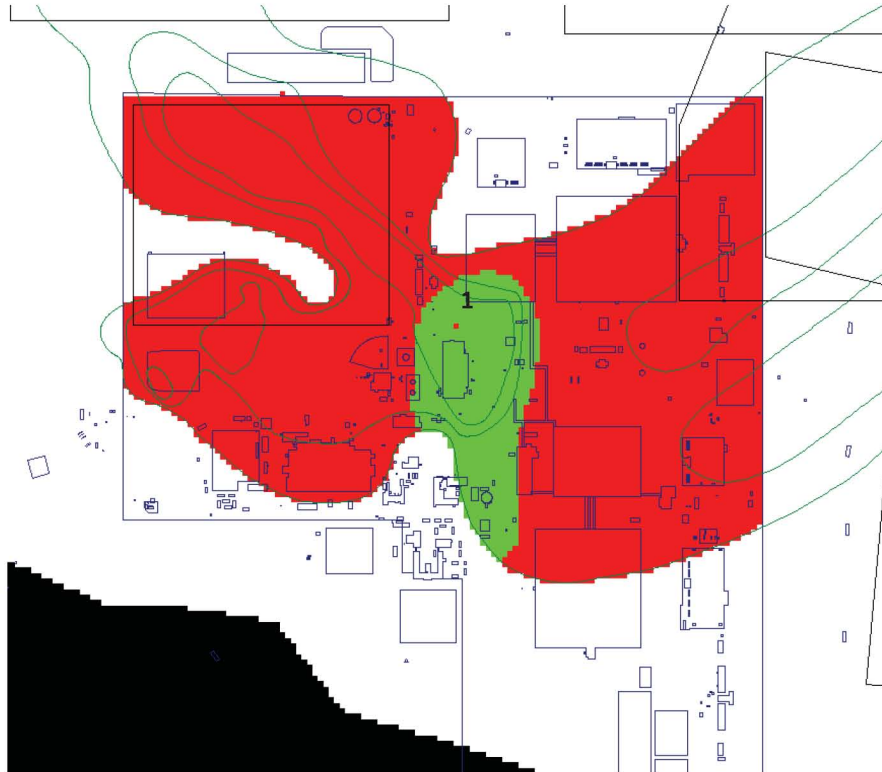

■ Not Captured
 ■ Captured

October 2011 – Maximum Anthropogenic Recharge

GPM

Well	Iteration			
	1	2	3	4
1	80	80	80	80
2		220	220	220
3			50	50
4				50
Total	80	300	350	400

Mass Capture

Well	Iteration			
	1	2	3	4
1	53.58%	51.68%	51.90%	52.24%
2		37.82%	38.11%	38.67%
3			0.13%	0.13%
4				0.12%
Total	53.58%	89.50%	90.14%	91.17%



It is possible to pin C400 dissolved contamination

50 GPM

C400 Extraction Well Evaluation : PGDP

C-45

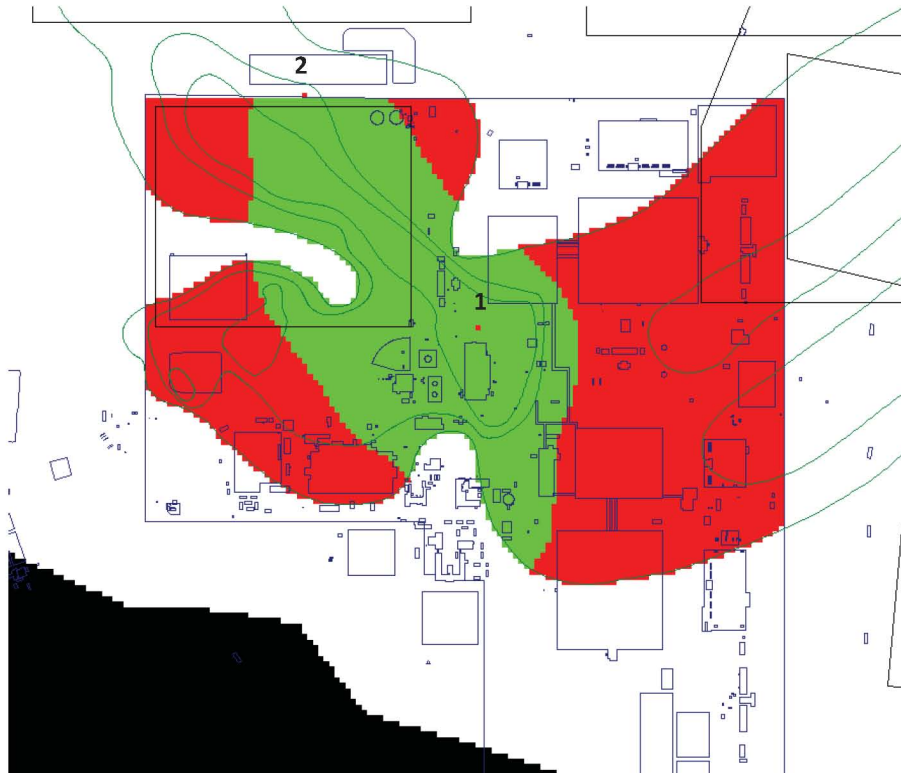

■ Not Captured ■ Captured

October 2011 – Maximum Anthropogenic Recharge

GPM

Well	Iteration			
	1	2	3	4
1	80	80	80	80
2		220	220	220
3			50	50
4				50
Total	80	300	350	400

Mass Capture

Well	Iteration			
	1	2	3	4
1	53.58%	51.68%	51.90%	52.24%
2		37.82%	38.11%	38.67%
3			0.13%	0.13%
4				0.12%
Total	53.58%	89.50%	90.14%	91.17%

50 GPM

C400 Extraction Well Evaluation : PGDP

C-46

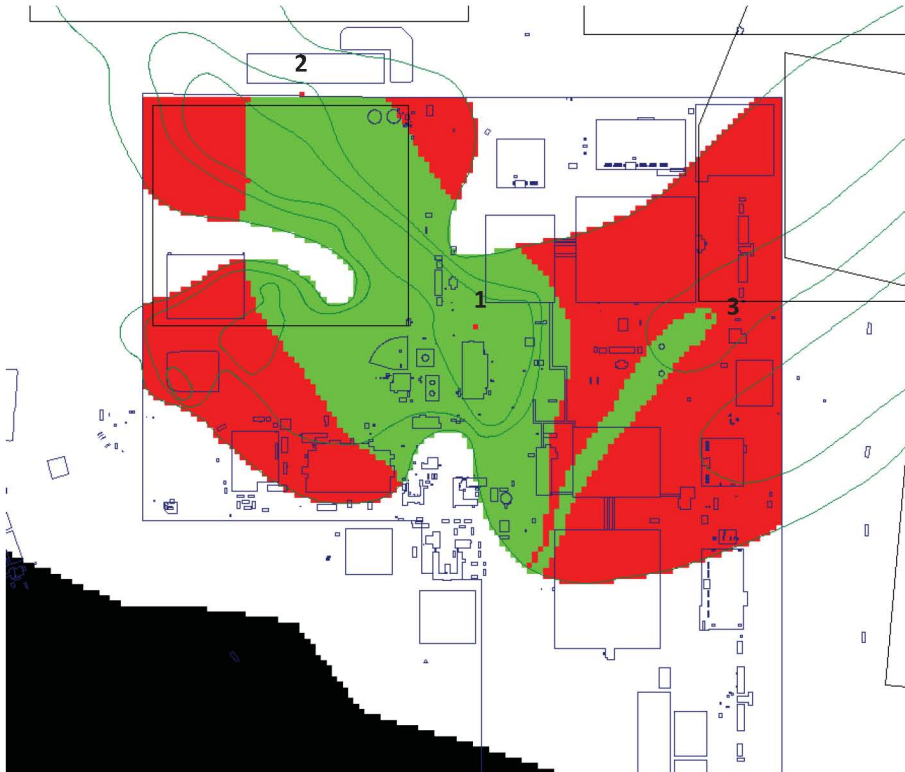

■ Not Captured ■ Captured

October 2011 – Maximum Anthropogenic Recharge

GPM

Well	Iteration			
	1	2	3	4
1	80	80	80	80
2		220	220	220
3			50	50
4				50
Total	80	300	350	400

Mass Capture

Well	Iteration			
	1	2	3	4
1	53.58%	51.68%	51.90%	52.24%
2		37.82%	38.11%	38.67%
3			0.13%	0.13%
4				0.12%
Total	53.58%	89.50%	90.14%	91.17%

50 GPM

C400 Extraction Well Evaluation : PGDP

C-47

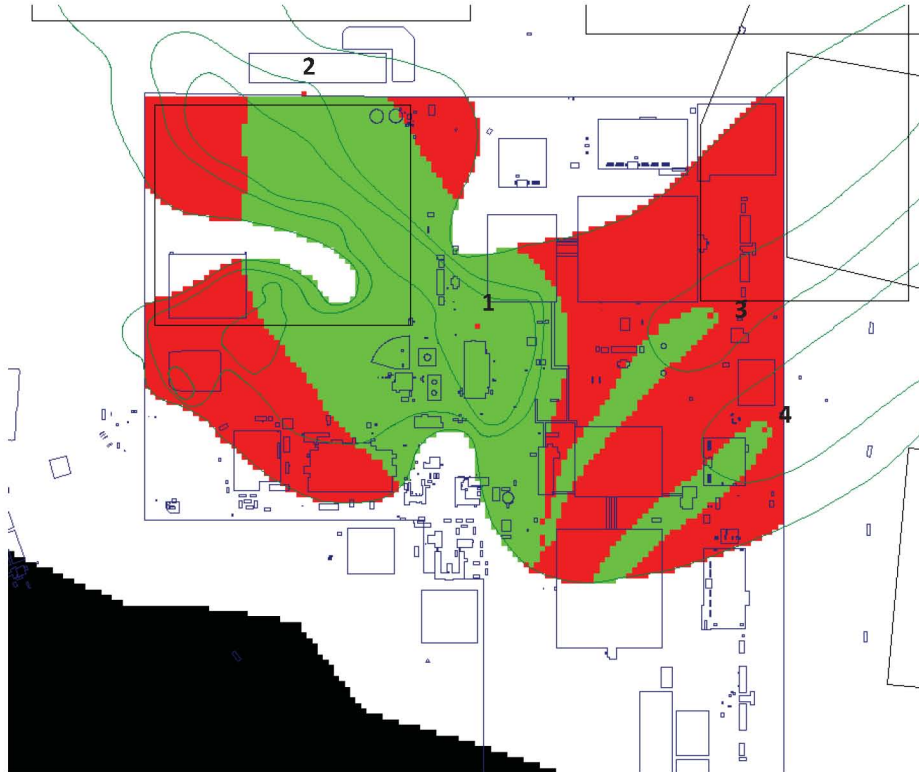

■ Not Captured ■ Captured

October 2011 – Maximum Anthropogenic Recharge

GPM

Well	Iteration			
	1	2	3	4
1	80	80	80	80
2		220	220	220
3			50	50
4				50
Total	80	300	350	400

Mass Capture

Well	Iteration			
	1	2	3	4
1	53.58%	51.68%	51.90%	52.24%
2		37.82%	38.11%	38.67%
3			0.13%	0.13%
4				0.12%
Total	53.58%	89.50%	90.14%	91.17%

50 GPM

C400 Extraction Well Evaluation : PGDP

C-48

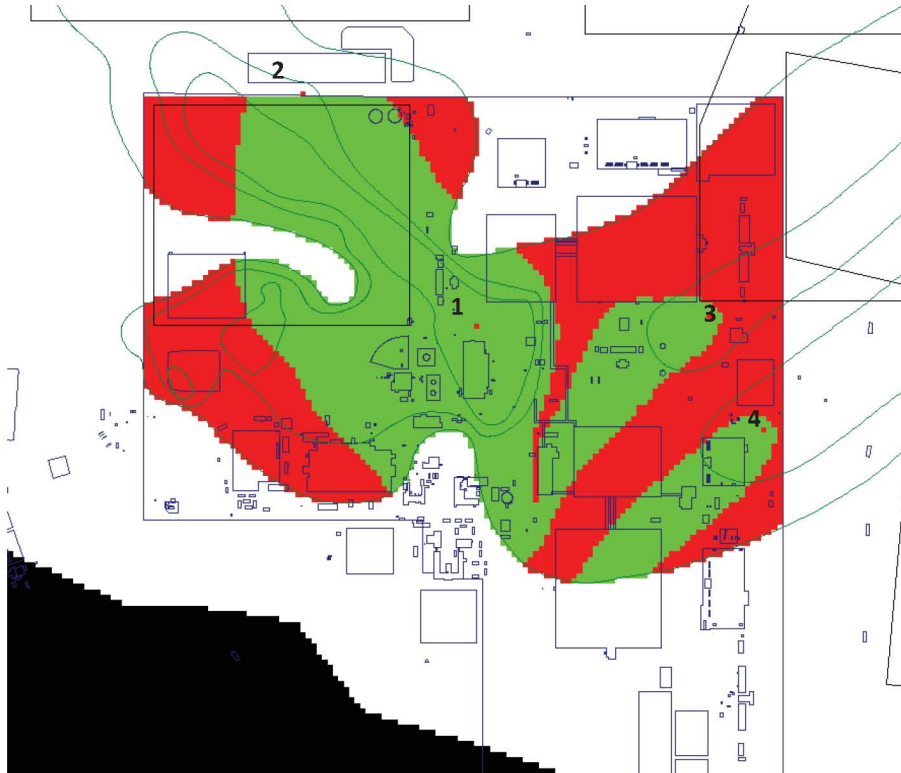

■ Not Captured ■ Captured

October 2011 – Maximum Anthropogenic Recharge

GPM

Well	Iteration			
	1	2	3	4
1	80	80	80	80
2		220	220	220
3			100	100
4				100
Total	80	300	400	500

Mass Capture

Well	Iteration			
	1	2	3	4
1	53.58%	51.68%	52.17%	53.18%
2		37.82%	38.80%	38.65%
3			0.23%	0.25%
4				0.22%
Total	53.58%	89.50%	91.20%	92.30%

100 GPM

C400 Extraction Well Evaluation : PGDP

C-49

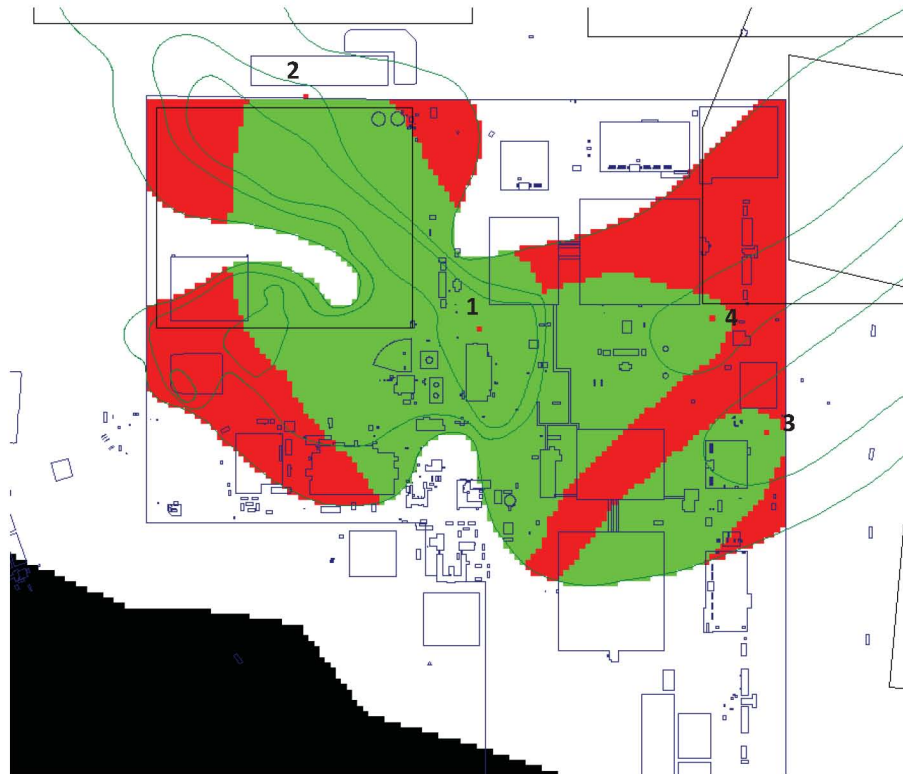

■ Not Captured ■ Captured

October 2011 – Maximum Anthropogenic Recharge

GPM

Well	Iteration			
	1	2	3	4
1	80	80	80	80
2		220	220	220
3			150	150
4				150
Total	80	300	450	600

Mass Capture

Well	Iteration			
	1	2	3	4
1	53.58%	51.68%	52.83%	54.34%
2		37.82%	38.30%	38.67%
3			0.31%	0.31%
4				0.33%
Total	53.58%	89.50%	91.44%	93.65%

150 GPM

C400 Extraction Well Evaluation : PGDP

C-50

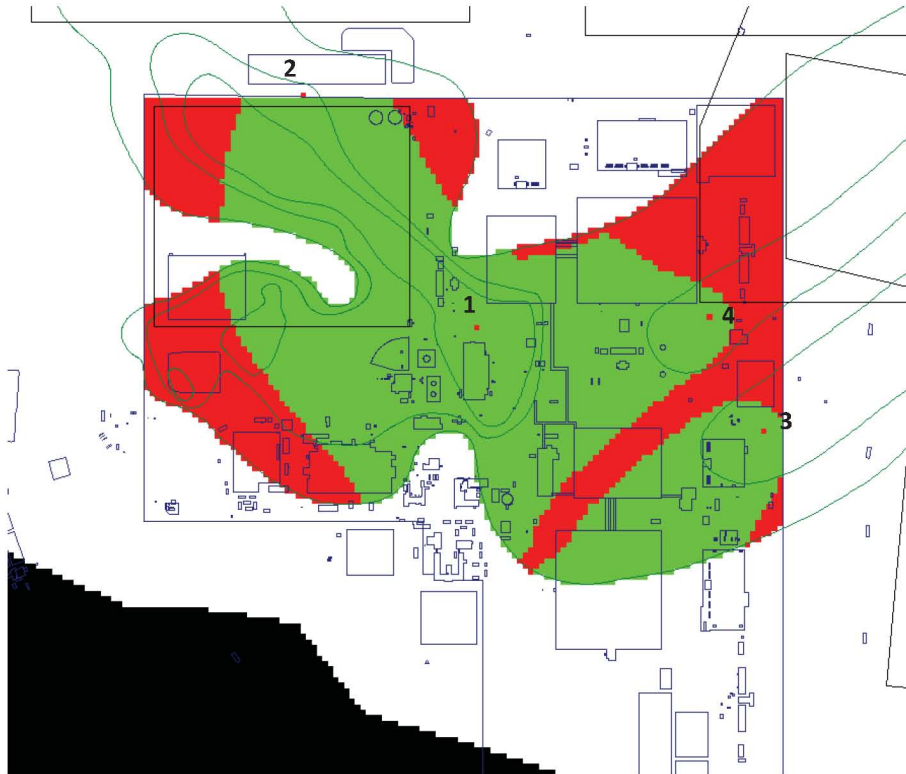

■ Not Captured ■ Captured

October 2011 – Maximum Anthropogenic Recharge

GPM

Well	Iteration			
	1	2	3	4
1	80	80	80	80
2		220	220	220
3			200	200
4				200
Total	80	300	500	700

Mass Capture

Well	Iteration			
	1	2	3	4
1	53.58%	51.68%	53.29%	55.91%
2		37.82%	38.51%	38.18%
3			0.36%	0.37%
4				0.52%
Total	53.58%	89.50%	92.16%	94.98%

200 GPM

C400 Extraction Well Evaluation : PGDP

C-51



■ Not Captured ■ Captured

October 2011 – Maximum Anthropogenic Recharge

GPM

Well	Iteration			
	1	2	3	4
1	80	80	80	80
2		220	220	220
3			250	250
4				250
Total	80	300	550	800

Mass Capture

Well	Iteration			
	1	2	3	4
1	53.58%	51.68%	53.77%	57.34%
2		37.82%	38.48%	37.35%
3			0.40%	0.40%
4				1.09%
Total	53.58%	89.50%	92.65%	96.18%

250 GPM

C400 Extraction Well Evaluation : PGDP

C-52

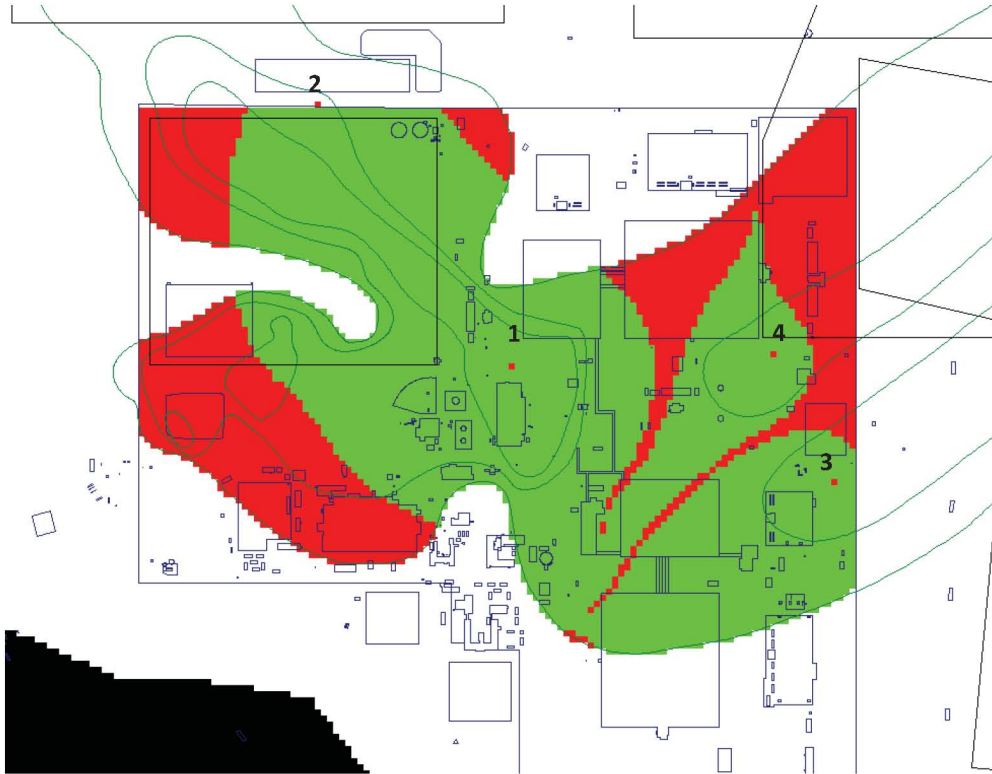

■ Not Captured
 ■ Captured

1Q 2007 – Average Anthropogenic Recharge

GPM

Well	Iteration			
	1	2	3	4
1	80	80	80	80
2		220	220	220
3			150	150
4				150
Total	80	300	450	600

Mass Capture

Well	Iteration			
	1	2	3	4
1	53.55%	51.65%	52.85%	54.81%
2		37.99%	38.83%	38.97%
3			0.41%	0.41%
4				0.42%
Total	53.55%	89.64%	92.08%	94.62%

150 GPM

C400 Extraction Well Evaluation : PGDP

C-53



■ Not Captured ■ Captured

GPM				
Well	Iteration			
	1	2	3	4
1	80	80	80	80
2		220	220	220
3			150	150
4				150
Total	80	300	450	600

Mass Capture				
Well	Iteration			
	1	2	3	4
1	56.02%	52.65%	54.31%	57.44%
2		43.95%	43.86%	41.46%
3			0.54%	0.45%
4				0.53%
Total	56.02%	96.60%	98.71%	99.89%

150 GPM

April 2012 – Minimum Anthropogenic Recharge Conditions

C400 Extraction Well Evaluation : PGDP

C-54

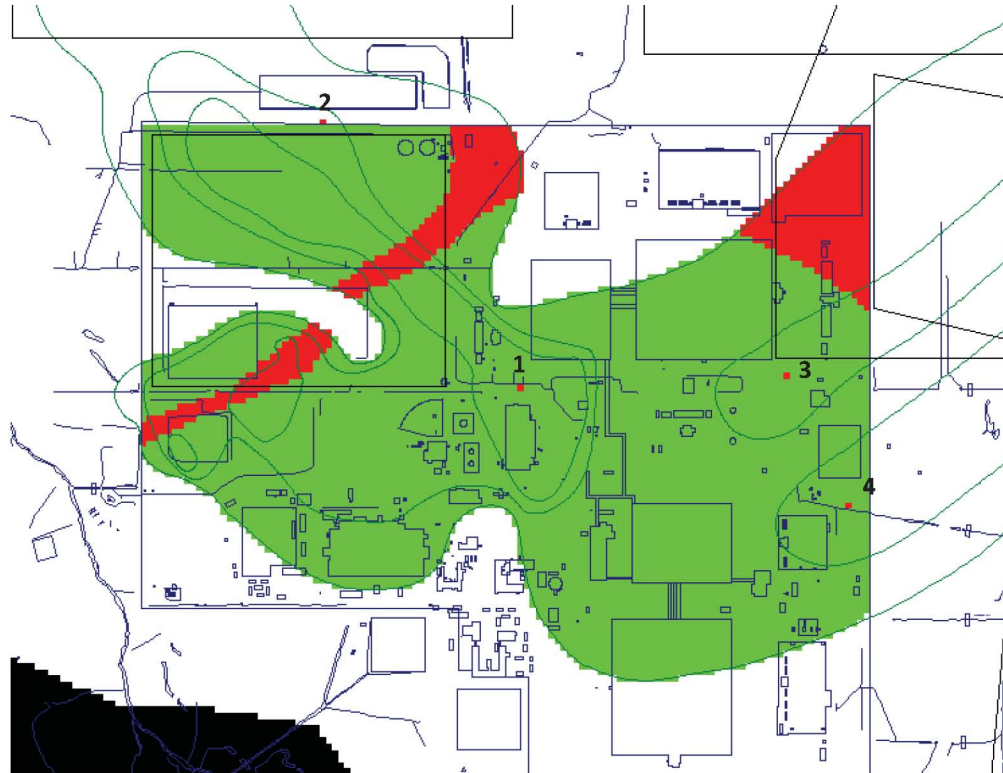

■ Not Captured ■ Captured

October 2012 – No Anthropogenic Recharge

GPM

Well	Iteration			
	1	2	3	4
1	80	80	80	80
2		220	220	220
3			150	150
4				150
Total	80	300	450	600

Mass Capture

Well	Iteration			
	1	2	3	4
1	62.89%	57.94%	60.59%	62.02%
2		36.30%	31.68%	27.07%
3			0.84%	7.03%
4				0.42%
Total	62.89%	94.25%	93.11%	96.54%

150 GPM

Graphical Summary

NE Lobe Extraction Wells – 50 gpm/each

C-56

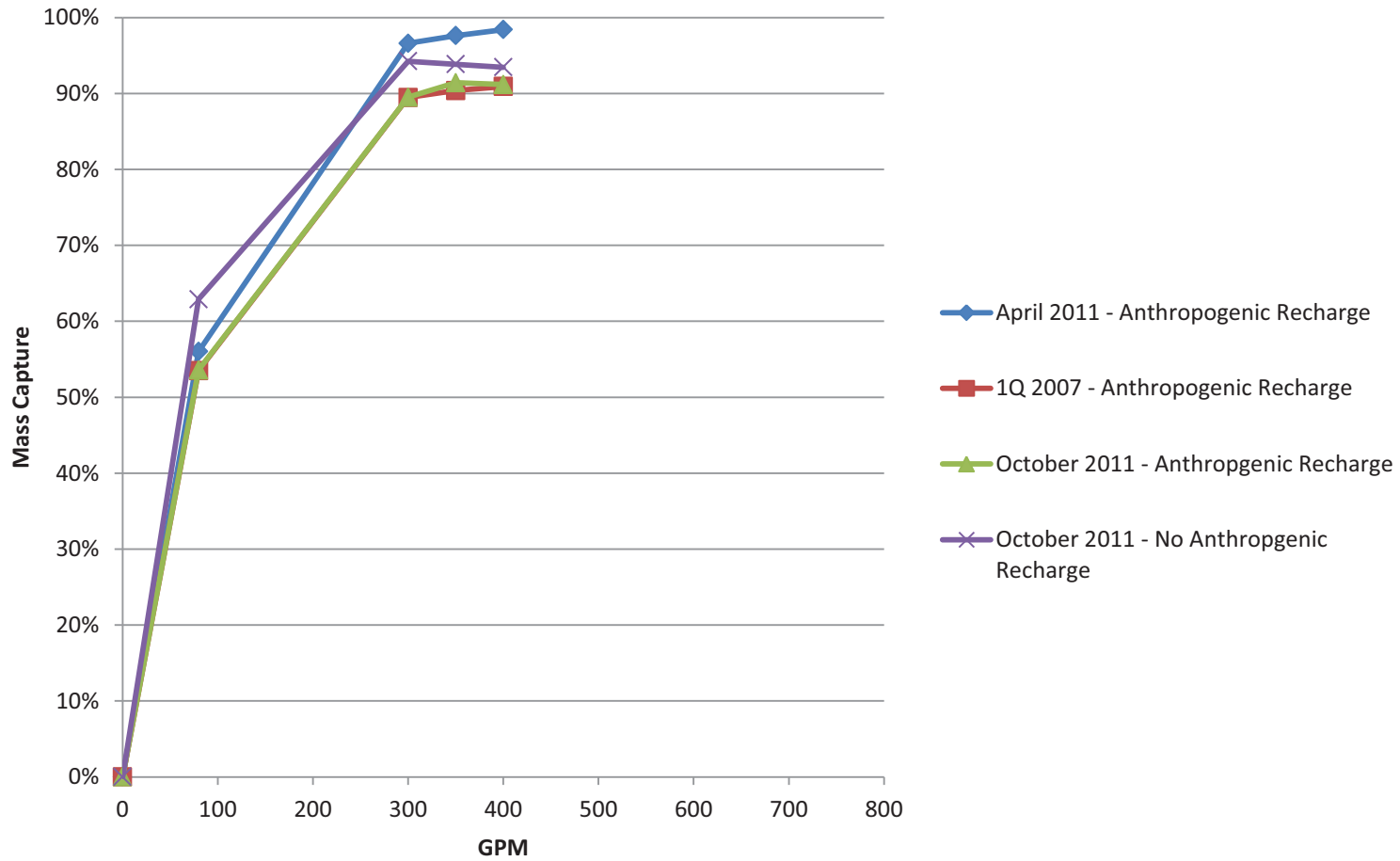

NE Lobe Extraction Wells – 100 gpm/each

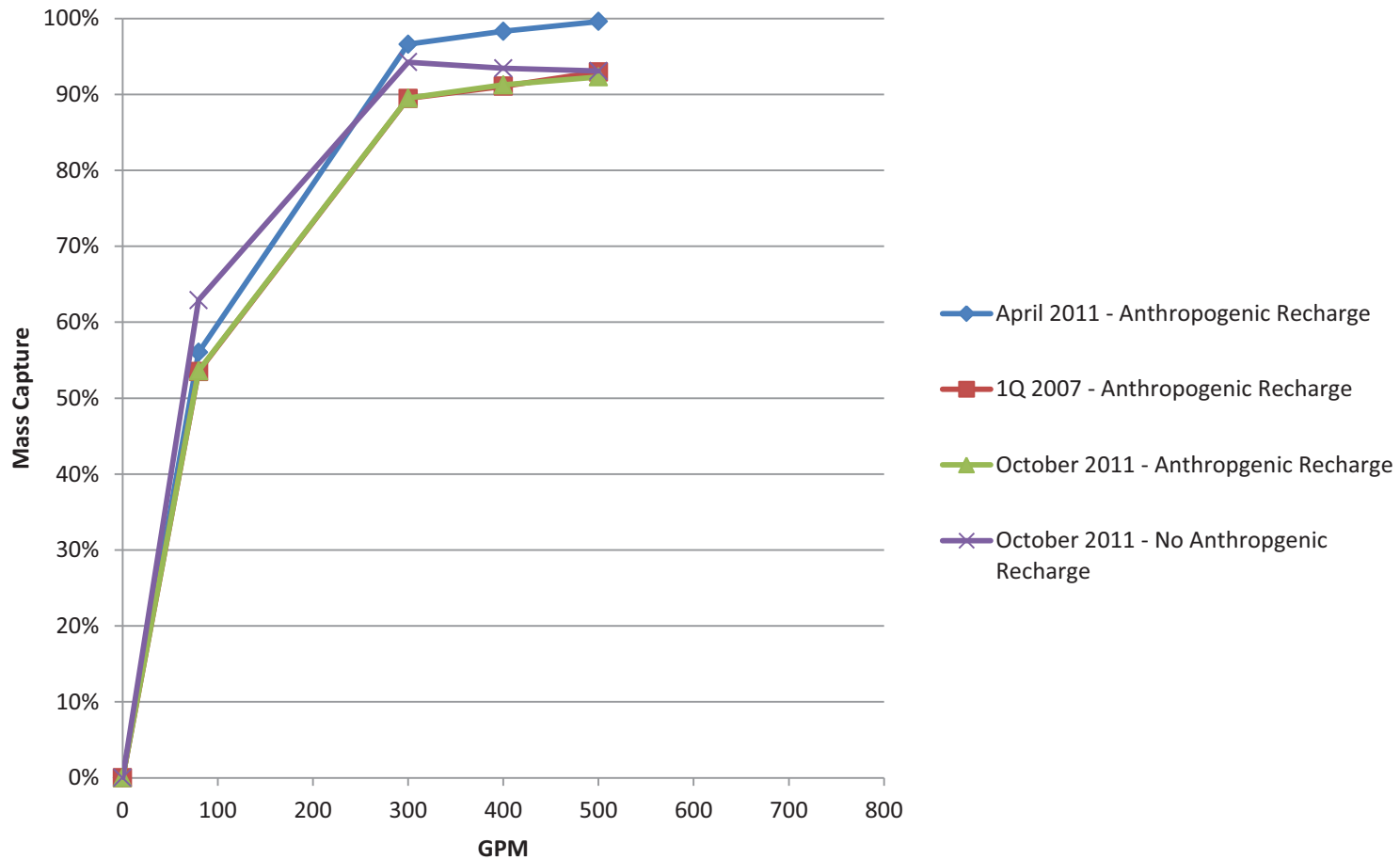

C-57

NE Lobe Extraction Wells – 150 gpm/each

C-58

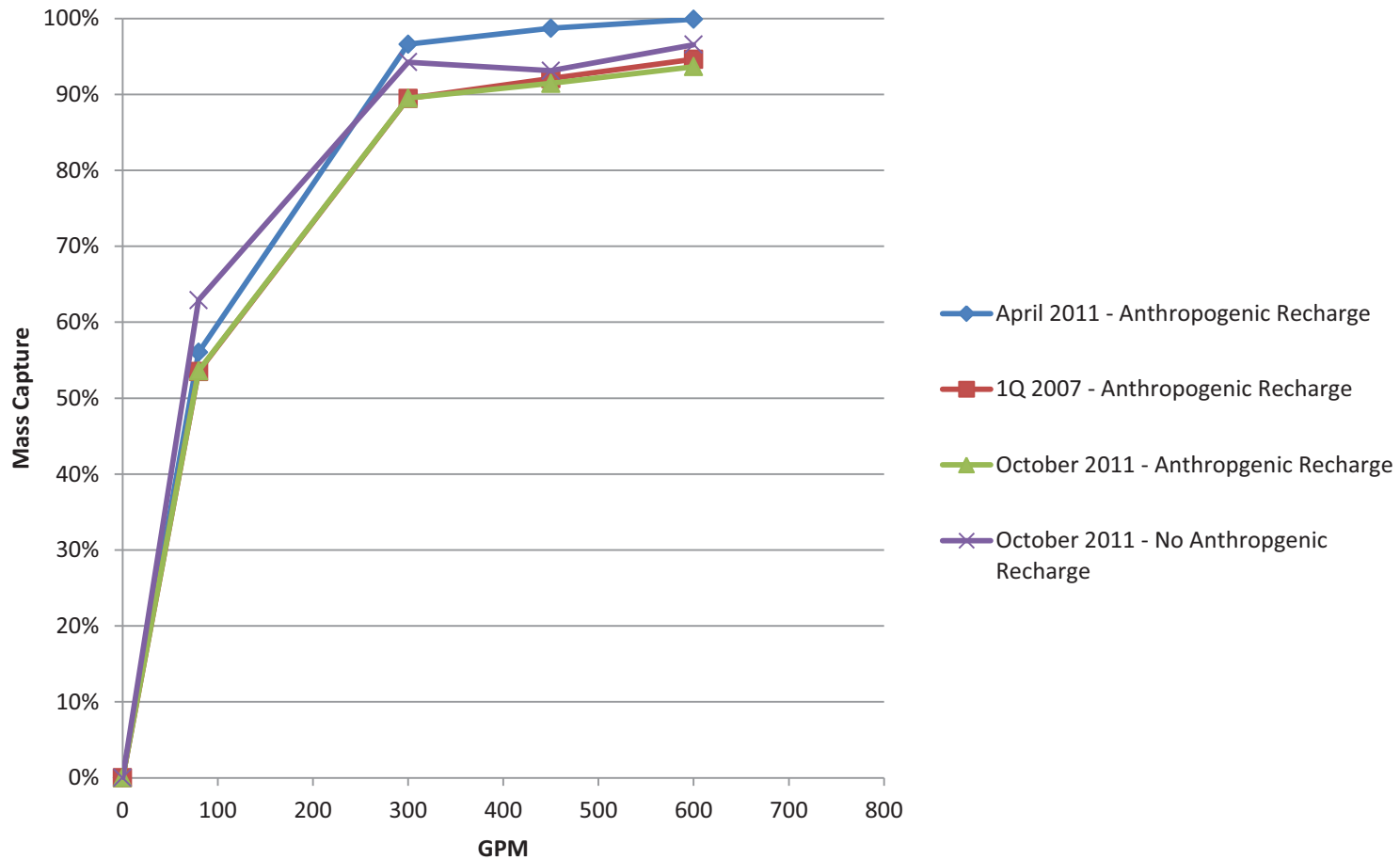

NE Lobe Extraction Wells – 200 gpm/each

C-59

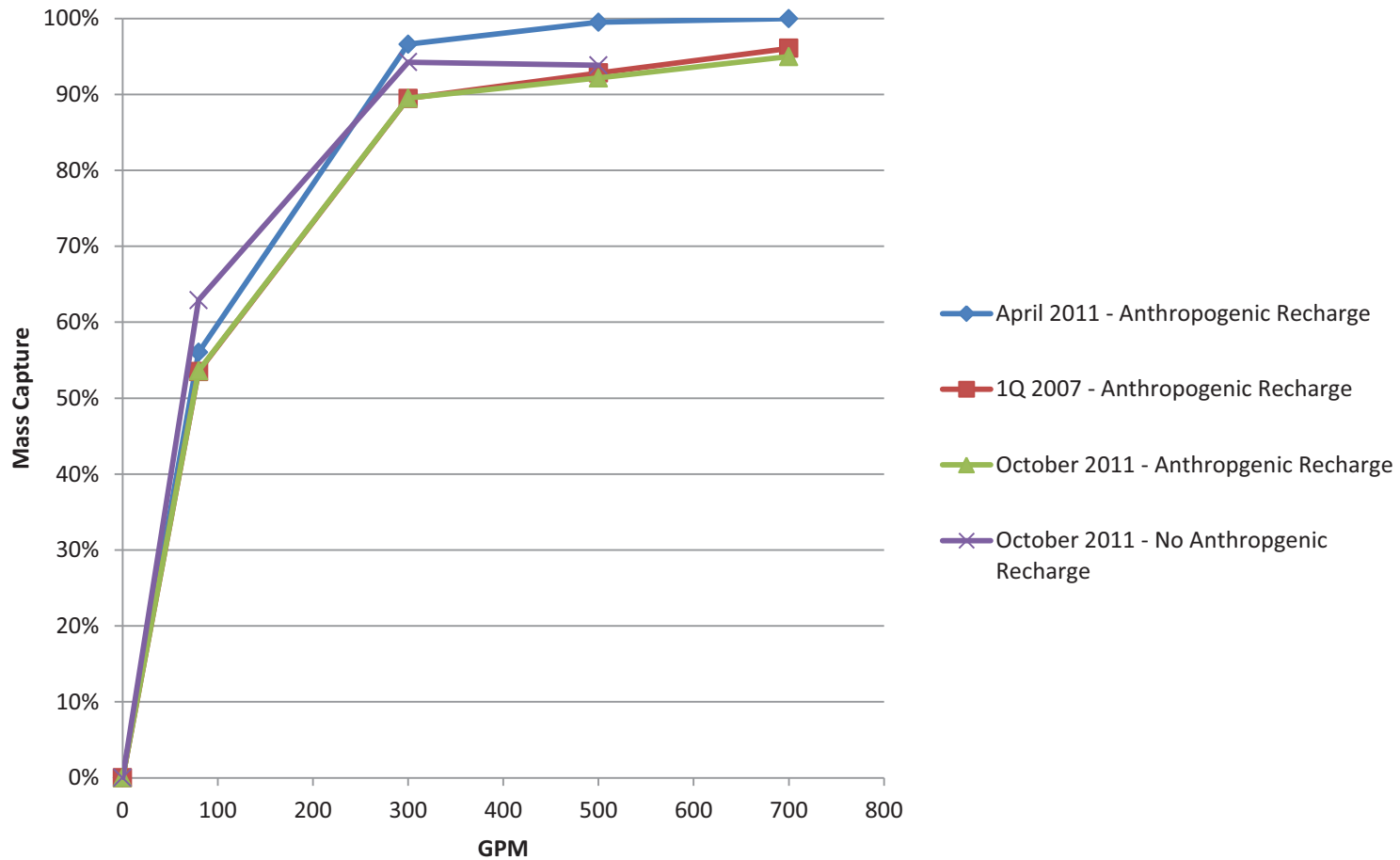

NE Lobe Extraction Wells – 250 gpm/each

C-60

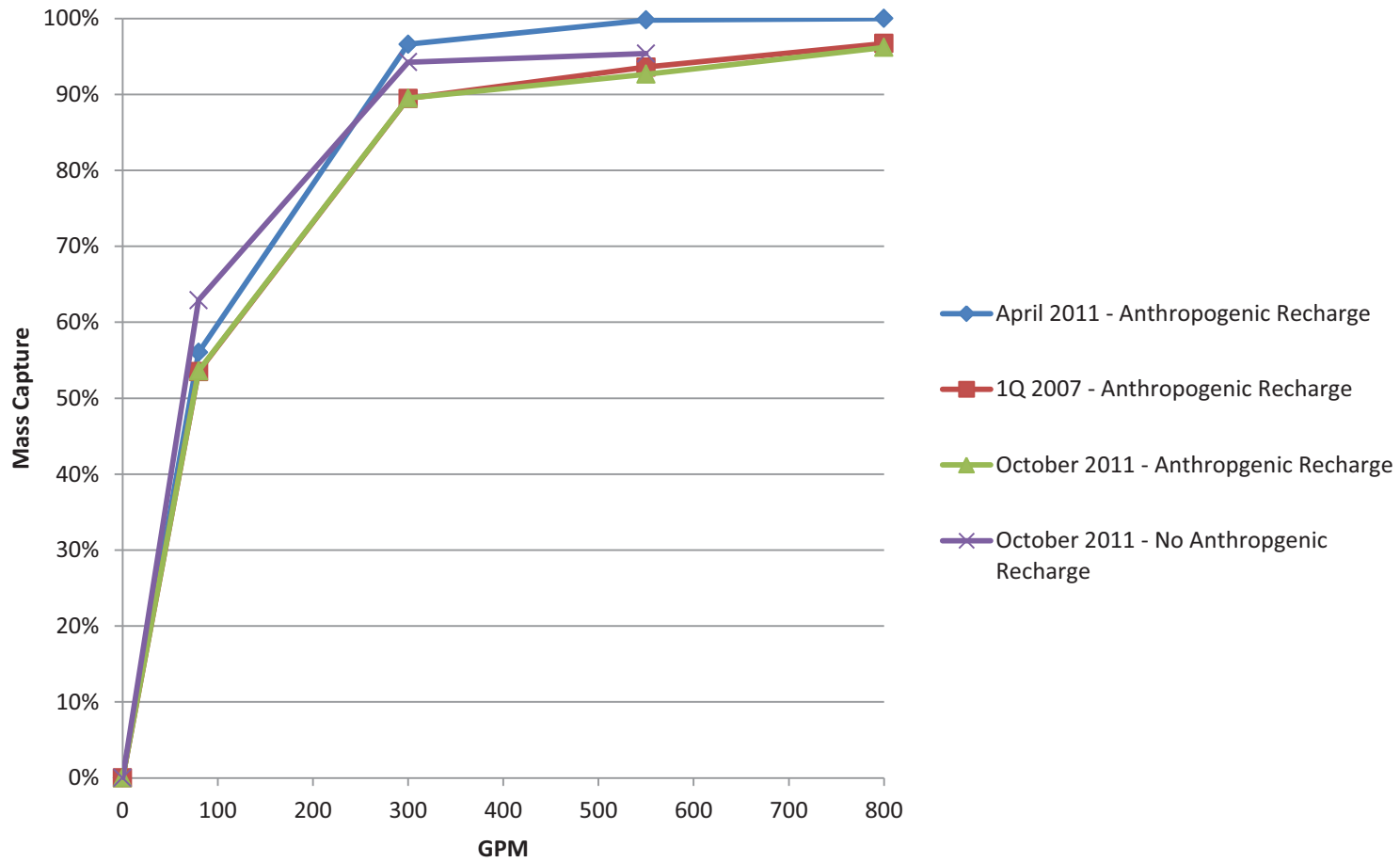

Performance Comparison Tables

50 GPM/Lobe Well	April 2011	1Q 2007	Oct 2011	No Anthropogenic Recharge
0	0.00%	0.00%	0.00%	0.00%
80	56.02%	53.50%	53.58%	62.89%
300	96.60%	89.47%	89.50%	94.25%
350	97.61%	90.38%	91.40%	93.85%
400	98.41%	90.92%	91.17%	93.44%

100 GPM/Lobe Well	April 2011	1Q 2007	Oct 2011	No Anthropogenic Recharge
0	0.00%	0.00%	0.00%	0.00%
80	56.02%	53.50%	53.58%	62.89%
300	96.60%	89.47%	89.50%	94.25%
400	98.30%	91.07%	91.25%	93.42%
500	99.59%	92.96%	92.30%	93.08%

150 GPM/Lobe Well	April 2011	1Q 2007	Oct 2011	No Anthropogenic Recharge
0	0.00%	0.00%	0.00%	0.00%
80	56.02%	53.50%	53.58%	62.89%
300	96.60%	89.47%	89.50%	94.25%
450	98.71%	92.08%	91.44%	93.11%
600	99.89%	94.62%	93.65%	96.54%

200 GPM/Lobe Well	April 2011	1Q 2007	Oct 2011	No Anthropogenic Recharge
0	0.00%	0.00%	0.00%	0.00%
80	56.02%	53.50%	53.58%	62.89%
300	96.60%	89.47%	89.50%	94.25%
500	99.49%	92.82%	92.16%	93.82%
700	99.98%	96.06%	94.98%	

250 GPM/Lobe Well	April 2011	1Q 2007	Oct 2011	No Anthropogenic Recharge
0	0.00%	0.00%	0.00%	0.00%
80	56.02%	53.50%	53.58%	62.89%
300	96.60%	89.47%	89.50%	94.25%
550	99.79%	93.58%	92.65%	95.38%
800	99.99%	96.70%	96.18%	

C-61

Summary

Satisfying Design Constraints

- Minimize trajectory impacts at C400 (YES)
- Complement NW Extraction Well capture zones (YES)
- Avoid potential CERCLA Cell locations (YES)
- Manage anthropogenic recharge variability (YES)
- Design for both anthropogenic and no anthropogenic recharge conditions to the extent possible (PGDP vs Post-PGDP) (YES)

Proposed Design

- EW 232 or EW233 Pumping at 220 gpm
 - Further evaluation planned
- C400 Extraction Well Pumping at 80 gpm
- Two NE Plume Higher Concentration Lobe Wells Pumping at 150 gpm/well
- Cumulative Extraction Rate is 600 gpm
- System performance monitoring, both water-levels and concentrations

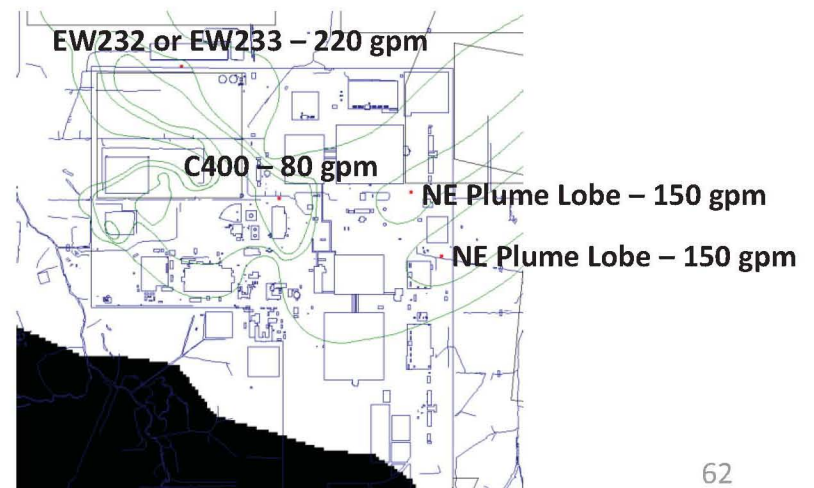
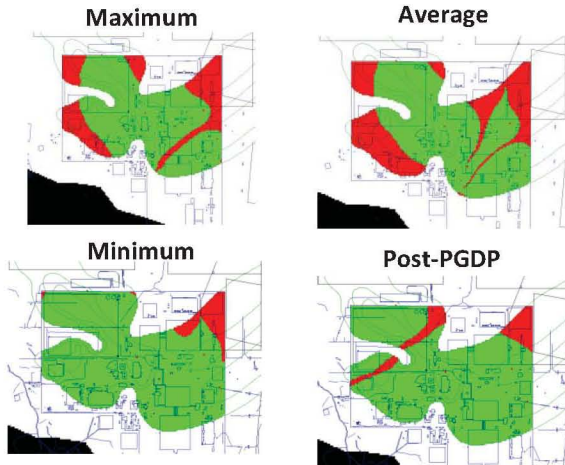

Northeast Plume Optimization Evaluations

Project Meeting

August 15, 2012

C-65



**LATA Environmental Services
of Kentucky, LLC**

Northeast Plume Optimization Evaluation

Status

- Provided model recalibration and design briefing to EPA and KY on 7/26/12
- Completed sequencing evaluation for installation of new NE Plume extraction wells and undesirable impacts to C-400 dissolved phase mass
- Completed evaluation of NW Plume extraction system operations relative to potential remedies under consideration for SWMU 7
- Received permission from Classification Officer to transmit executable code to EPA on 8/15/12

C-66



C-400 Contaminant Migration Evaluation

- Pumped EW233 at 220 gpm and the two NE extraction wells at 150 gpm/each
- C400 extraction well was not pumped
- Migrated particles located in the vicinity of C400 forward in time two years
- Imported the green C400 well capture zone from the optimization design effort to see if the two year particle traces were within the green area
- If the particles remain within the green capture zone then it is safe to leave the C400 well off line for two years while the other extraction wells are operated

C-67



C-400 Particle Locations

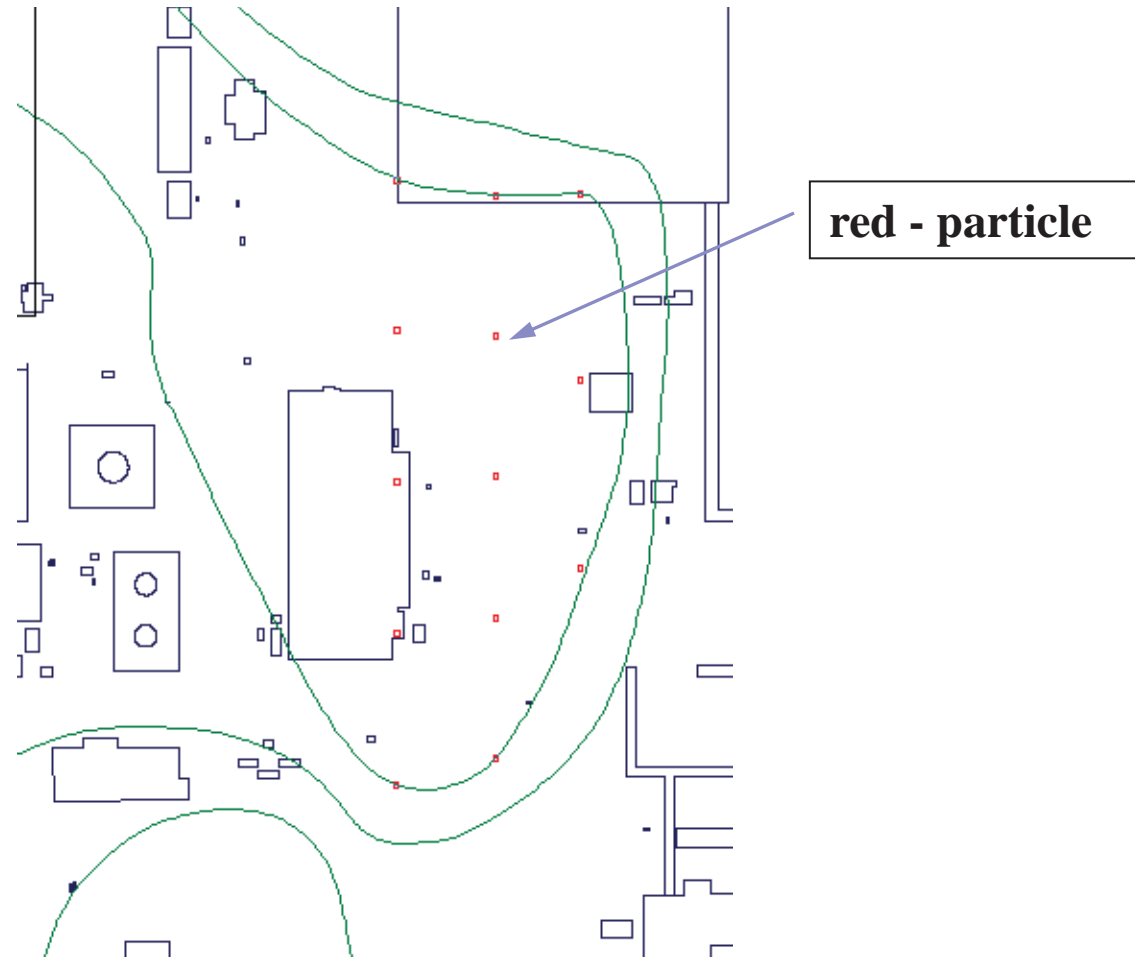

C-68



**LATA Environmental Services
of Kentucky, LLC**

Minimum Anthropogenic Recharge - Two Year Particle Traces

C-69

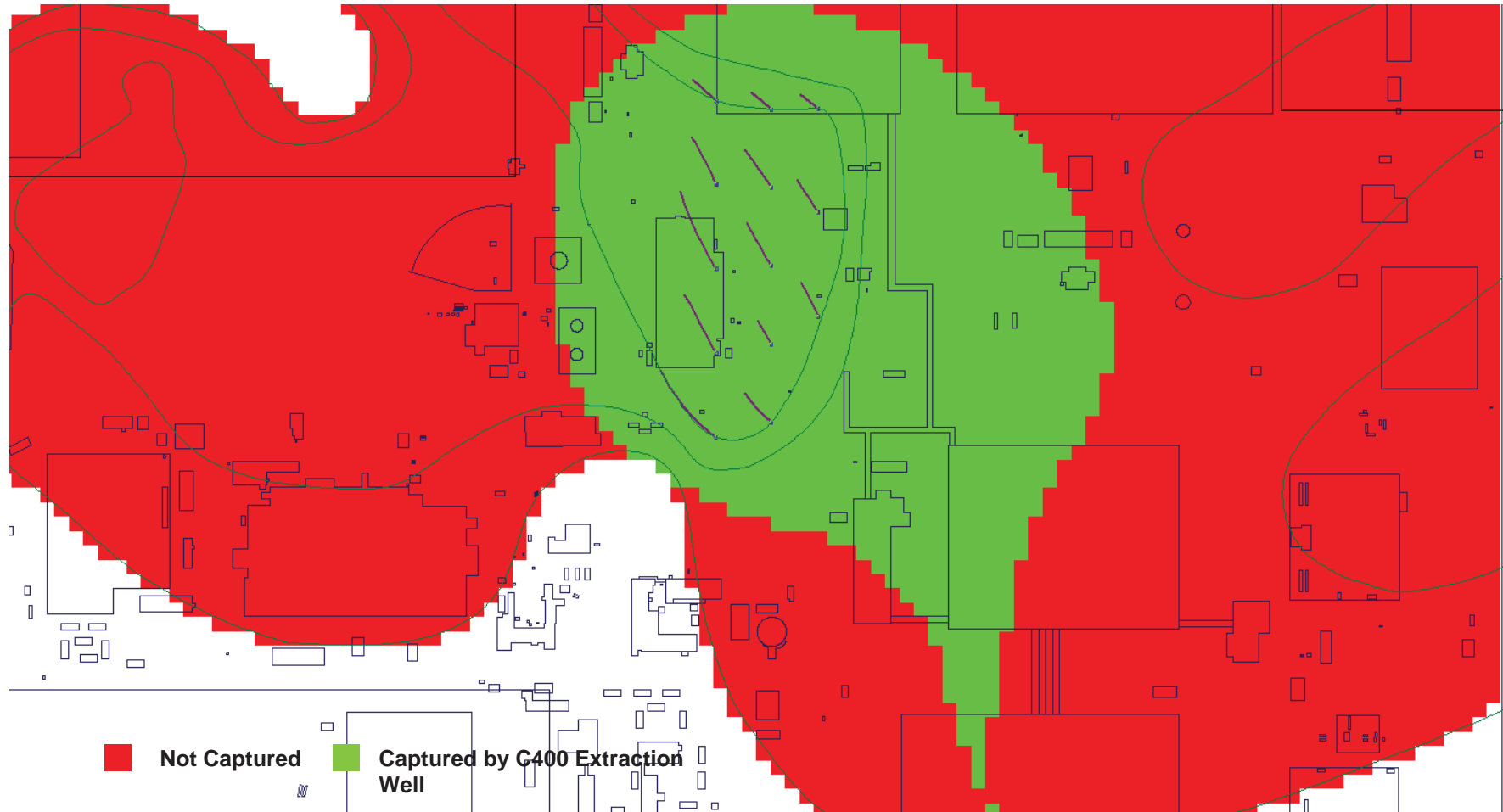

**LATA Environmental Services
of Kentucky, LLC**

Minimum Anthropogenic Recharge - Three Year Particle Traces

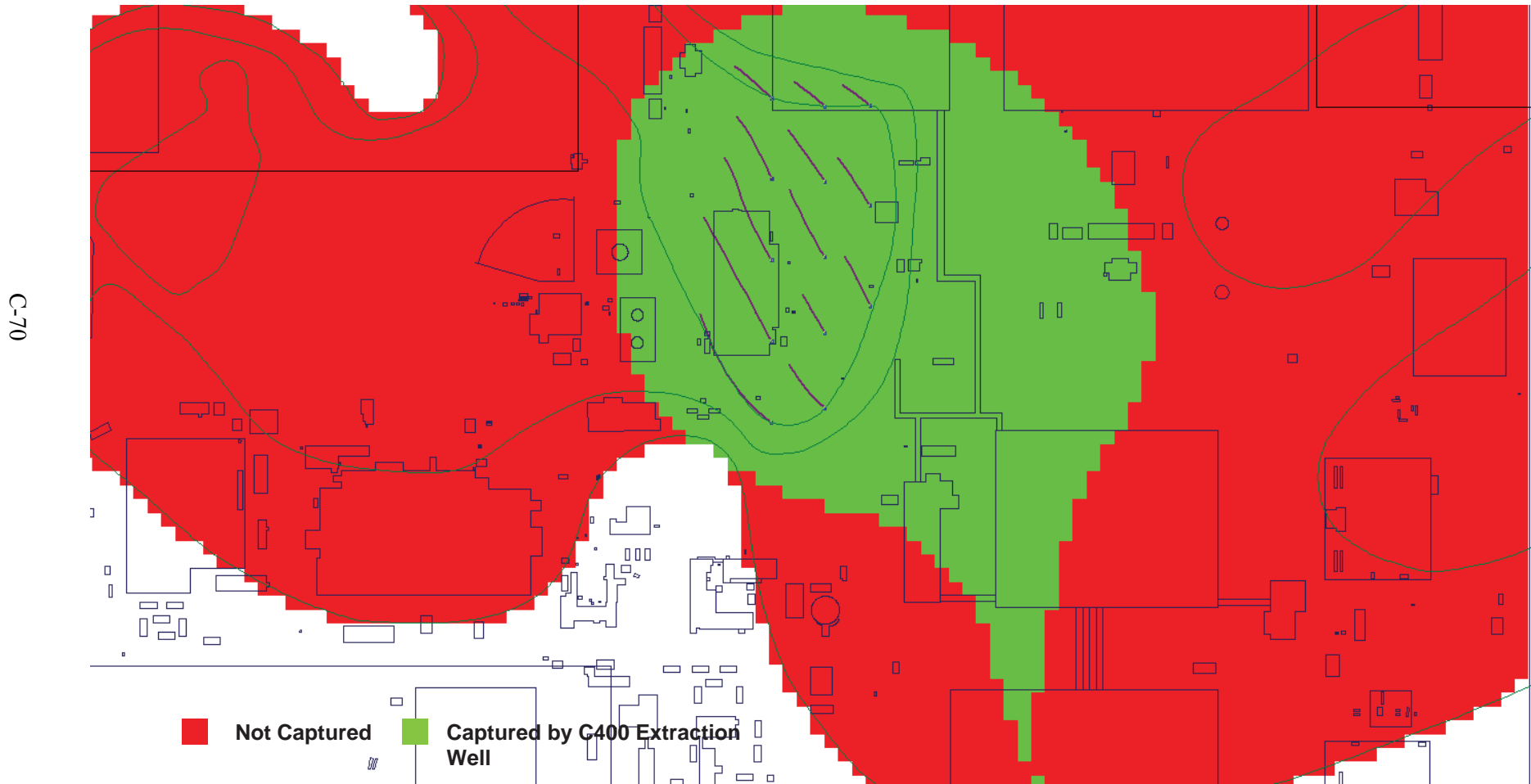

LATA Environmental Services
of Kentucky, LLC

Minimum Anthropogenic Recharge - Four Year Particle Traces

C-71

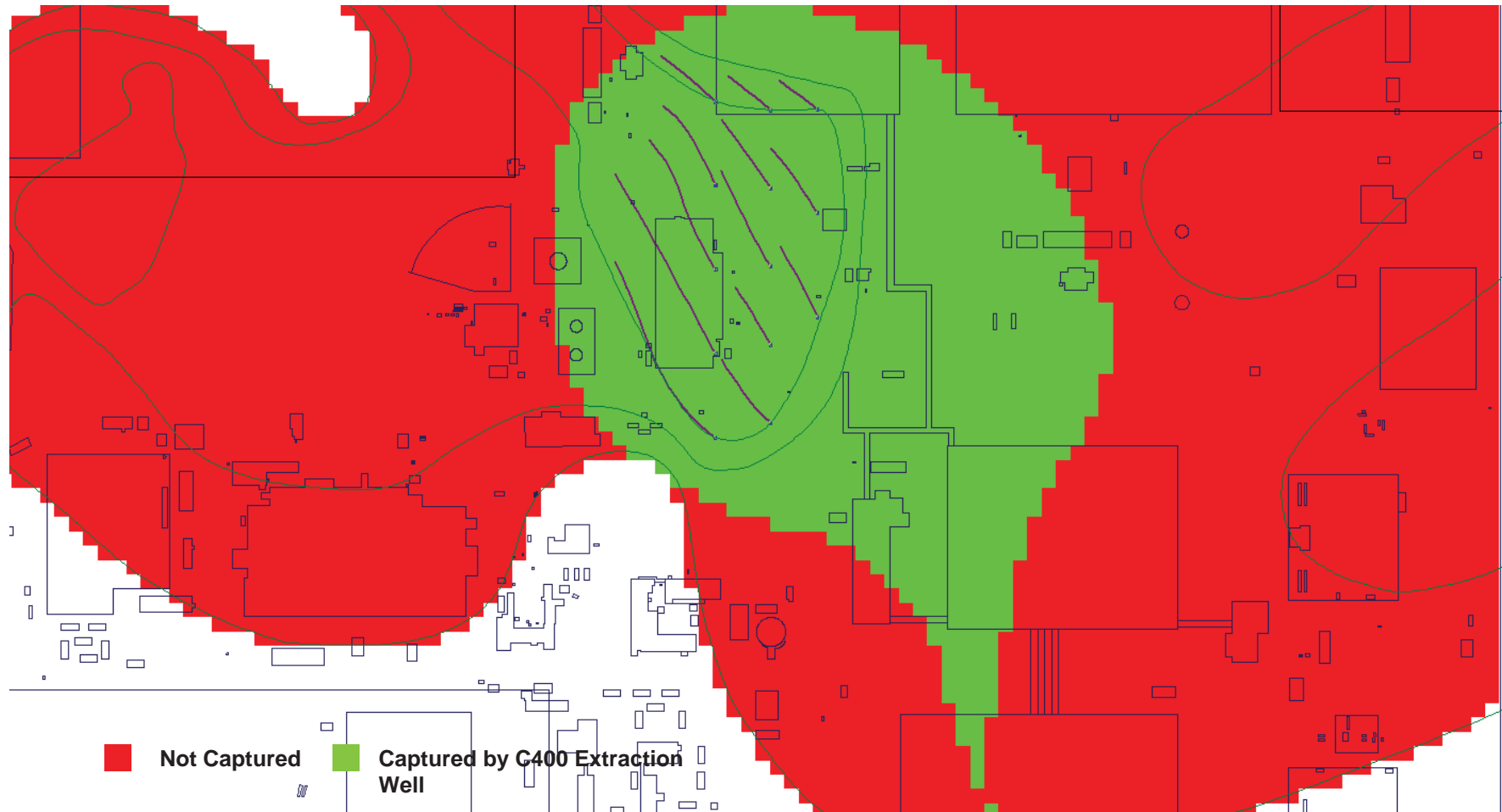

LATA Environmental Services
of Kentucky, LLC

Average Anthropogenic Recharge - Two Year Particle Traces

C-72



**LATA Environmental Services
of Kentucky, LLC**

Average Anthropogenic Recharge - Three Year Particle Traces

C-73



**LATA Environmental Services
of Kentucky, LLC**

Average Anthropogenic Recharge - Four Year Particle Traces

C-74

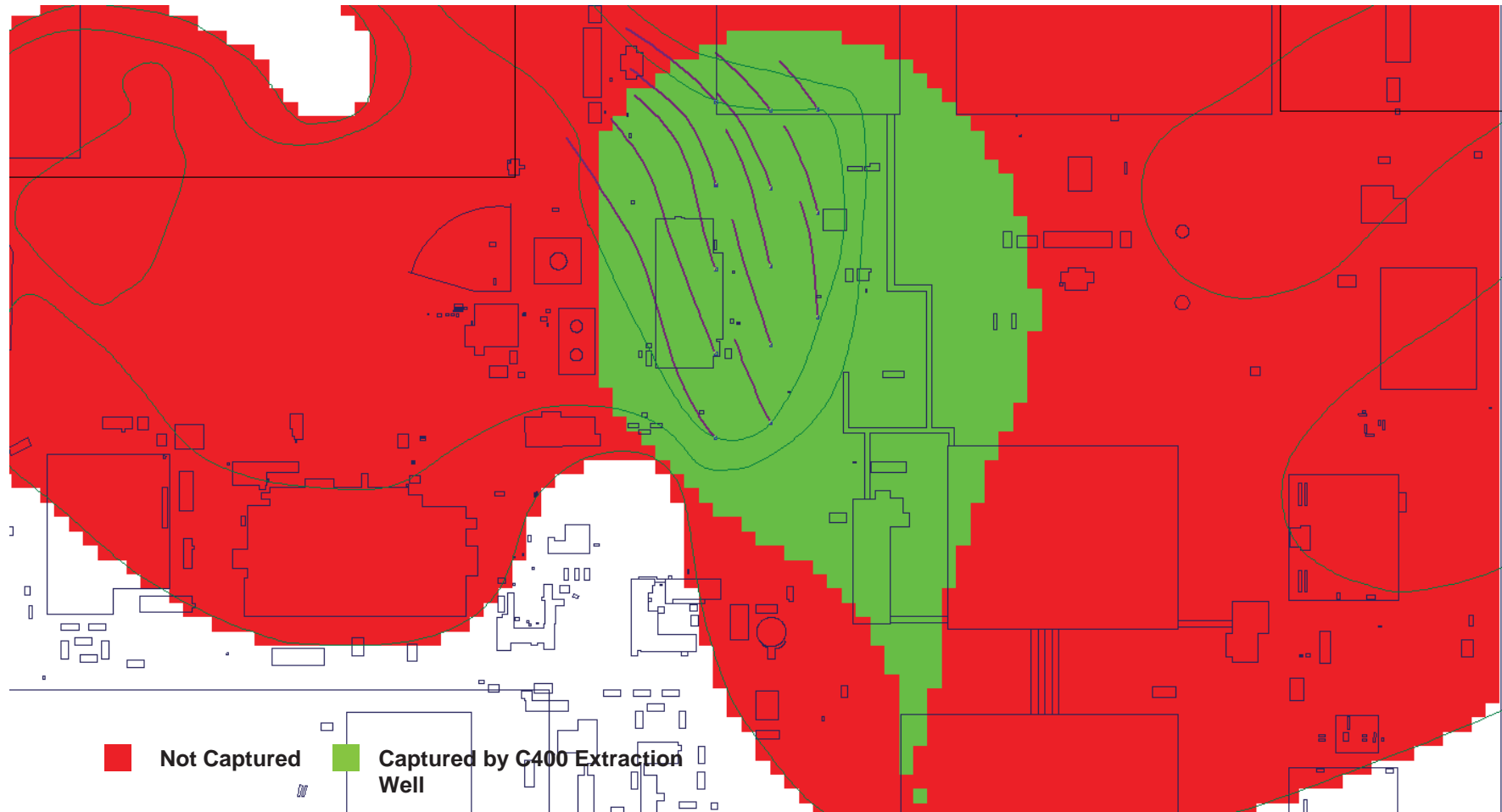

**LATA Environmental Services
of Kentucky, LLC**

Maximum Anthropogenic Recharge - Two Year Particle Traces

C-75



**LATA Environmental Services
of Kentucky, LLC**

Maximum Anthropogenic Recharge - Three Year Particle Traces

C-76



**LATA Environmental Services
of Kentucky, LLC**

Maximum Anthropogenic Recharge - Four Year Particle Traces

C-77



**LATA Environmental Services
of Kentucky, LLC**

Maximum Anthropogenic Recharge - Four Year Particle Traces

Average Anthropogenic C400 Capture Zone

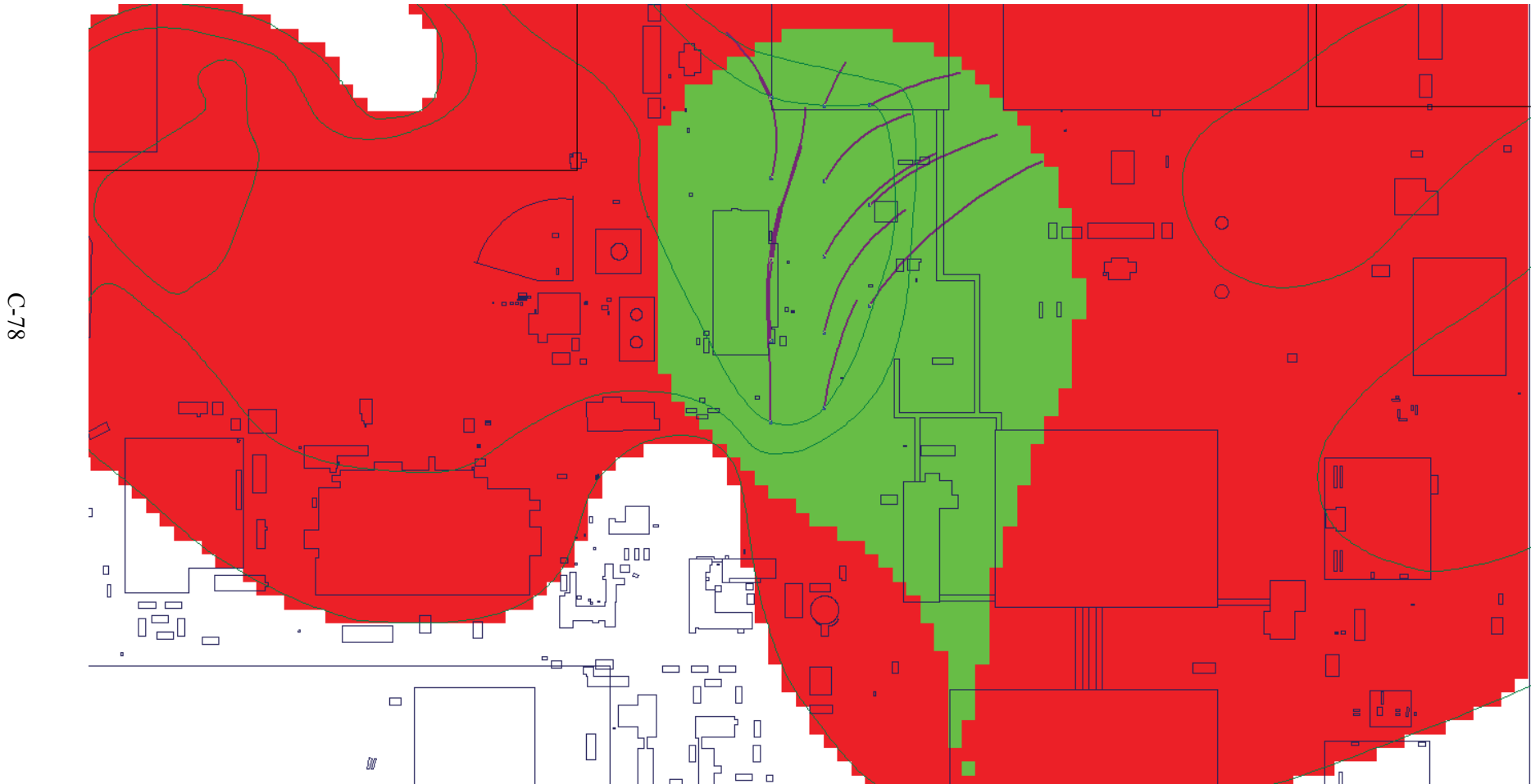

Maximum Anthropogenic Recharge - Four Year Particle Traces

Minimum Anthropogenic C400 Capture Zone

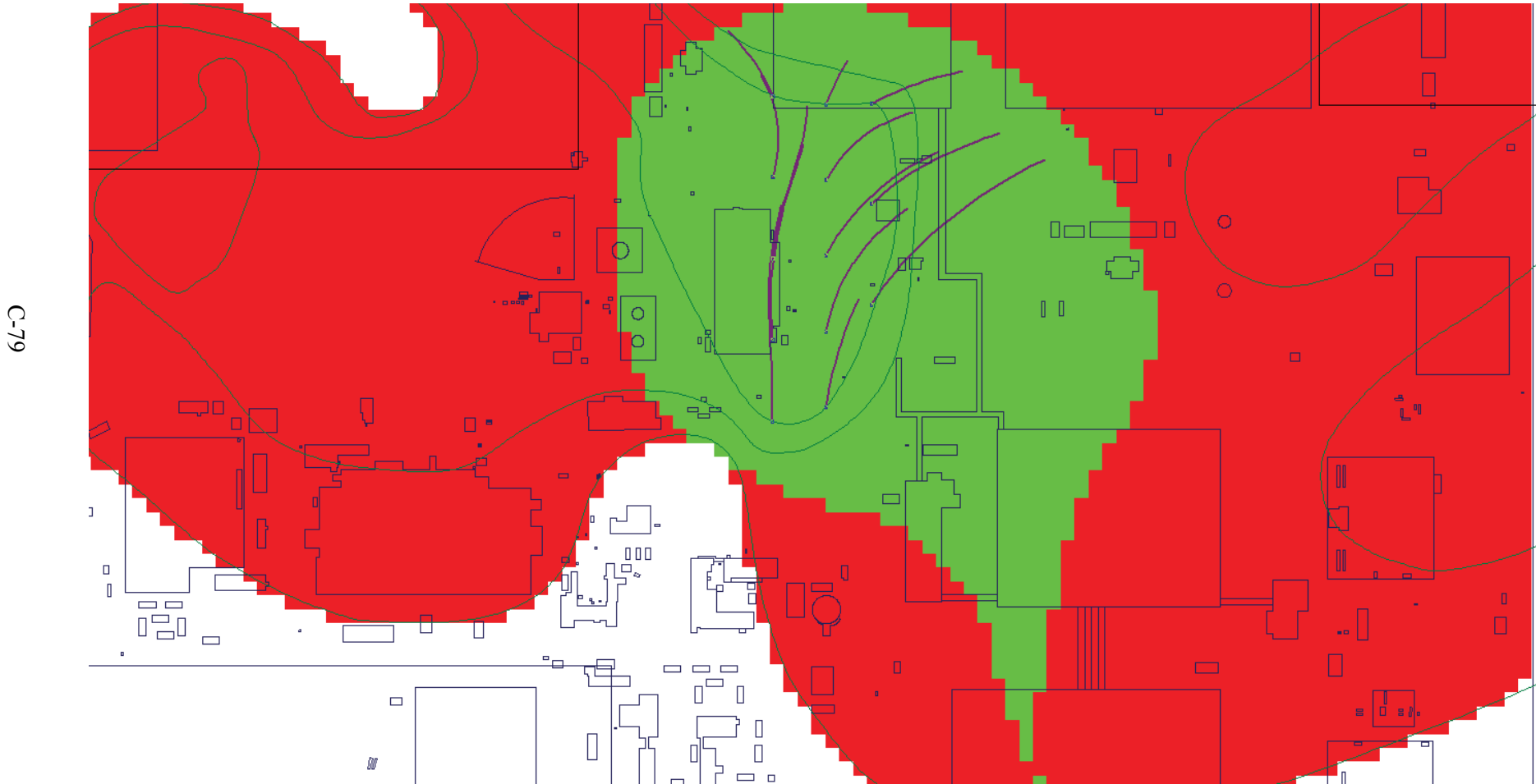

Comparison of EW232 and EW233 capture performance when combined with C400 and two new NE plume EWs



April 2011 – Minimum Anthropogenic Recharge

C-81

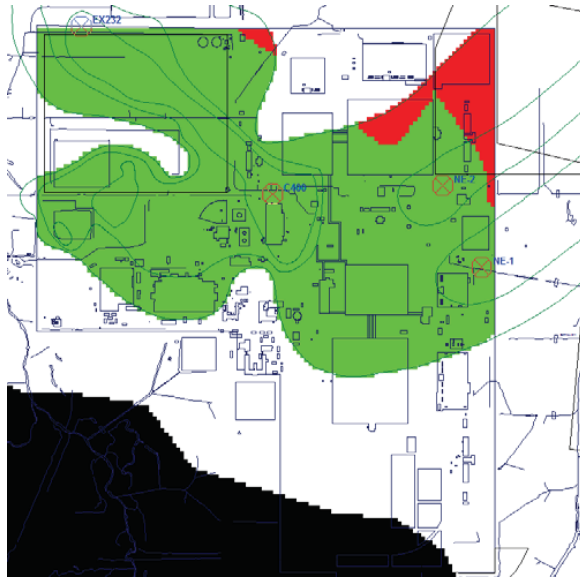

EW232

Well	Iteration			
	1	2	3	4
1	80	80	80	80
2		220	220	220
3			150	150
4				150
Total	80	300	450	600

GPM

Well	Iteration			
	1	2	3	4
1	56.00%	52.81%	55.21%	58.41%
2		46.17%	43.79%	40.49%
3			0.54%	0.45%
4				0.53%
Total	56.00%	98.98%	99.55%	99.88%

% Mass Capture



EW233

Well	Iteration			
	1	2	3	4
1	80	80	80	80
2		220	220	220
3			150	150
4				150
Total	80	300	450	600

GPM

Well	Iteration			
	1	2	3	4
1	56.02%	52.65%	54.31%	57.44%
2		43.95%	43.86%	41.46%
3			0.54%	0.45%
4				0.53%
Total	56.02%	96.60%	98.71%	99.89%

% Mass Capture



LATA Environmental Services
of Kentucky, LLC

Q1 2007 – Average Anthropogenic Recharge

C-82



EW232

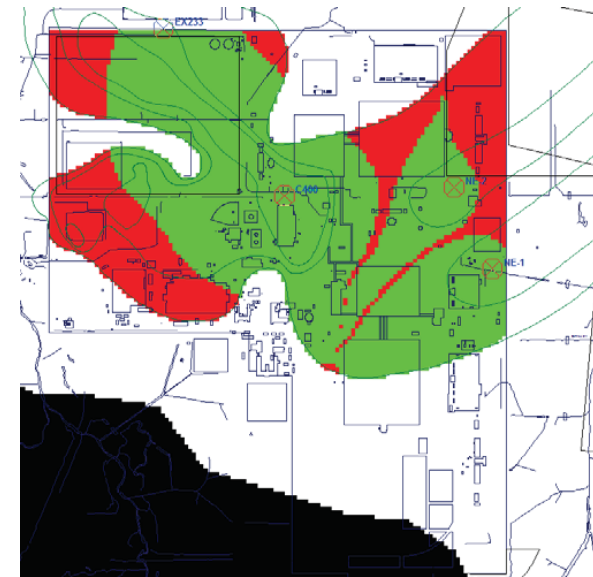

EW233

Well	Iteration			
	1	2	3	4
1	80	80	80	80
2		220	220	220
3			150	150
4				150
Total	80	300	450	600

GPM

Well	Iteration			
	1	2	3	4
1	53.55%	51.94%	53.34%	55.83%
2		44.60%	43.57%	41.57%
3			0.41%	0.41%
4				0.42%
Total	53.55%	96.53%	97.32%	98.23%

% Mass Capture

Well	Iteration			
	1	2	3	4
1	80	80	80	80
2		220	220	220
3			150	150
4				150
Total	80	300	450	600

GPM

Well	Iteration			
	1	2	3	4
1	53.55%	51.65%	52.85%	54.81%
2		37.99%	38.83%	38.97%
3			0.41%	0.41%
4				0.42%
Total	53.55%	89.64%	92.08%	94.62%

% Mass Capture



LATA Environmental Services of Kentucky, LLC

October 2011 – Maximum Anthropogenic Recharge

C-83

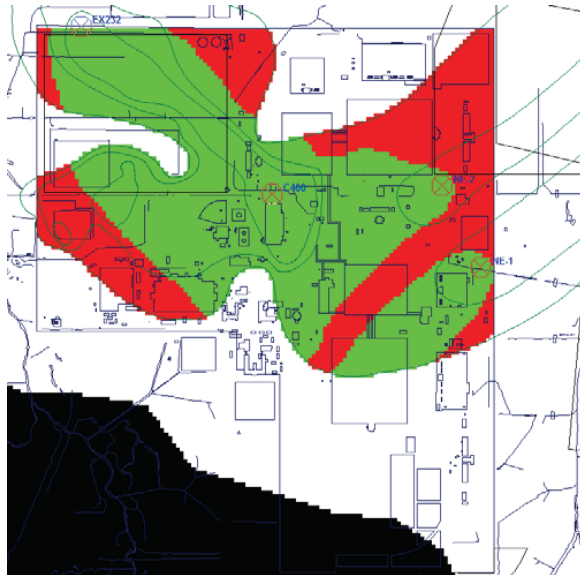

EW232

Well	Iteration			
	1	2	3	4
1	80	80	80	80
2		220	220	220
3			150	150
4				150
Total	80	300	450	600

GPM

Well	Iteration			
	1	2	3	4
1	53.58%	51.90%	53.23%	55.32%
2		45.17%	44.19%	42.48%
3			0.31%	0.31%
4				0.33%
Total	53.58%	97.08%	97.73%	98.44%

% Mass Capture

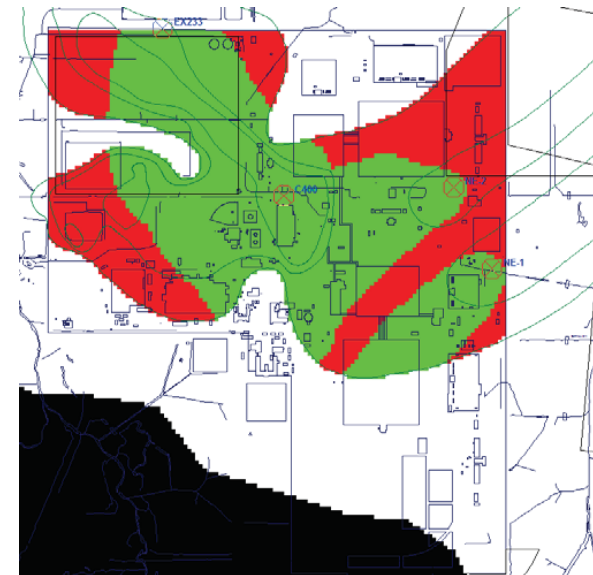

EW233

Well	Iteration			
	1	2	3	4
1	80	80	80	80
2		220	220	220
3			150	150
4				150
Total	80	300	450	600

GPM

Well	Iteration			
	1	2	3	4
1	53.58%	51.68%	52.83%	54.34%
2		37.82%	38.30%	38.67%
3			0.31%	0.31%
4				0.33%
Total	53.58%	89.50%	91.44%	93.65%

% Mass Capture



LATA Environmental Services
of Kentucky, LLC

Comparison of EW232 and EW233 capture performance when combined with two new NE plume Ews

C-84



April 2011 – Minimum Anthropogenic Recharge - No C-400 EW

C-85

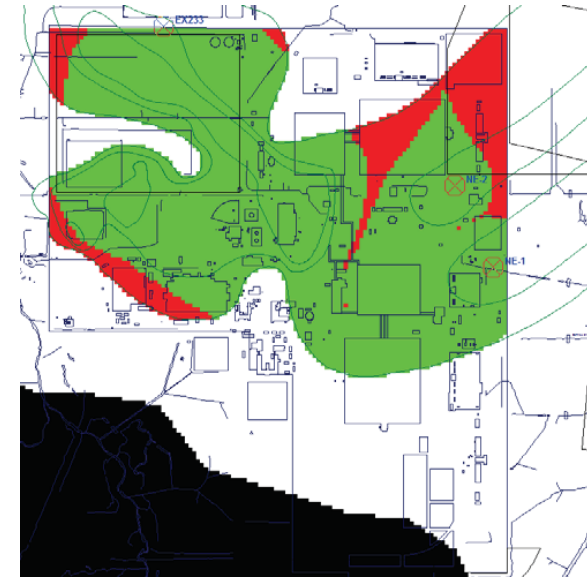

EW232

Well	Iteration		
	1	2	3
1	220	220	220
2		150	150
3			150
4			
Total	220	370	520

GPM

Well	Iteration		
	1	2	3
1	98.37%	98.87%	98.86%
2		0.51%	0.45%
3			0.50%
4			
Total	98.37%	99.38%	99.82%

% Mass Capture

EW233

Well	Iteration		
	1	2	3
1	220	220	220
2		150	150
3			150
4			
Total	220	370	520

GPM

Well	Iteration		
	1	2	3
1	94.59%	96.85%	98.37%
2		0.51%	0.45%
3			0.50%
4			
Total	94.59%	97.35%	99.33%

% Mass Capture



LATA Environmental Services
of Kentucky, LLC

Q1 2007 – Average Anthropogenic Recharge - No C-400 EW

C-86



EW232

Well	Iteration		
	1	2	3
1	220	220	220
2		150	150
3			150
4			
Total	220	370	520

GPM

Well	Iteration		
	1	2	3
1	96.15%	96.50%	96.92%
2		0.40%	0.41%
3			0.40%
4			
Total	96.15%	96.91%	97.73%

% Mass Capture



EW233

Well	Iteration		
	1	2	3
1	220	220	220
2		150	150
3			150
4			
Total	220	370	520

GPM

Well	Iteration		
	1	2	3
1	88.19%	89.94%	91.83%
2		0.40%	0.41%
3			0.40%
4			
Total	88.19%	90.34%	92.64%

% Mass Capture



LATA Environmental Services
of Kentucky, LLC

October 2011 – Maximum Anthropogenic Recharge - No C-400 EW

C-87



EW232

Well	Iteration		
	1	2	3
1	220	220	220
2		150	150
3			150
4			
Total	220	370	520

GPM

Well	Iteration		
	1	2	3
1	96.38%	92.29%	73.15%
2		0.30%	19.07%
3			0.30%
4			
Total	96.38%	92.59%	92.52%

% Mass Capture

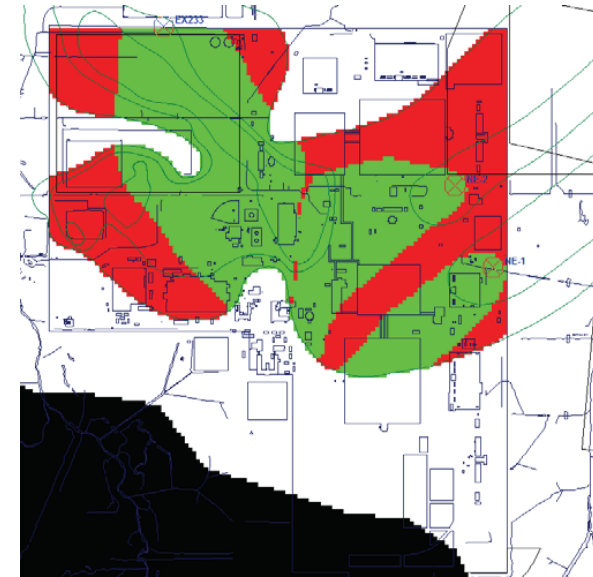

EW233

Well	Iteration		
	1	2	3
1	220	220	220
2		150	150
3			150
4			
Total	220	370	520

GPM

Well	Iteration		
	1	2	3
1	88.25%	86.31%	69.01%
2		0.30%	15.22%
3			0.30%
4			
Total	88.25%	86.61%	84.53%

% Mass Capture



LATA Environmental Services
of Kentucky, LLC

Northeast Plume System Optimization: EW235 Constructability Review

September 4, 2013

Issue Summary

- *Modeling for NE Plume Optimization identified locations for two new extraction wells near the eastern plant site fence line.*
- *EW234 can be constructed at the modeled location.*
- *The modeled location for EW235 is in a ravine south USEC construction offices west of Post 48.*
- *An alternate location for EW235 was identified along the axis of the southern 100 µg/L TCE isopleth.*
- *The alternate meets criteria for construction and operations (i.e., is accessible and avoids interferences with utilities, security, and other infrastructure).*
- *This location was evaluated using the groundwater flow model.*
- *The alternate location aligns well with predicted performance for the modeled location.*

Optimized Well Field &
Scenario 1

Alternate Location for EW235

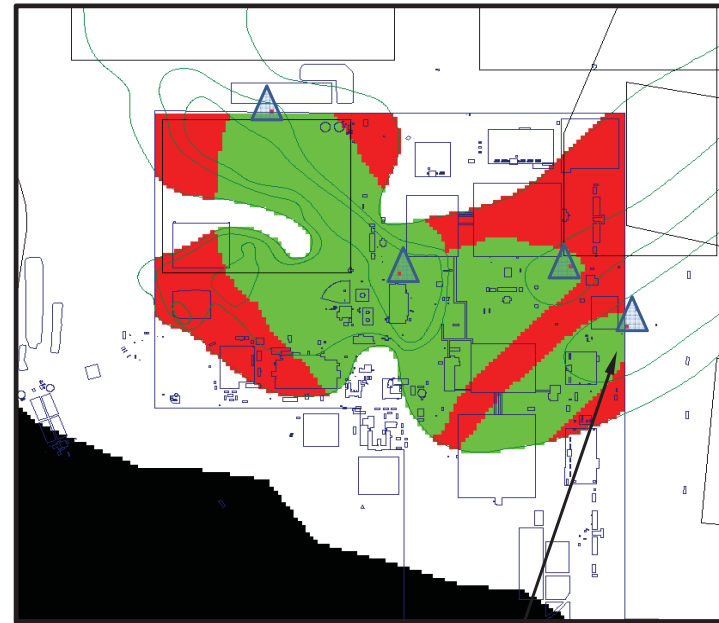
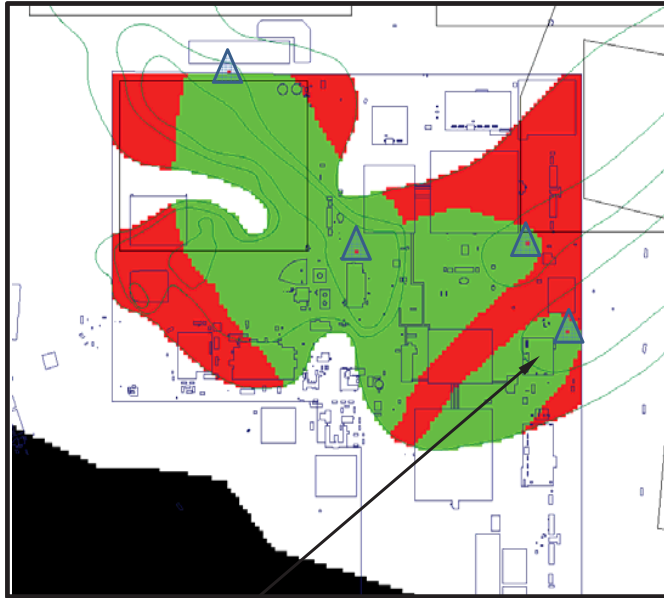

EW235

WELL	PUMPING RATE (gpm)	Optimized Well Field w/ C-400 EW	Optimized Well Field w/o C-400 EW	Alternate EW235 Location w/o C-400 EW	Alternate EW235 Location w/ C-400 EW
C-400	80	54.34%	-	-	54.27%
EW232	220	38.67%	74.77%	69.05%	38.73%
EW234	150	0.31%	15.40%	14.55%	0.32%
EW235	150	0.33%	0.30%	0.37%	0.38%
TOTAL MASS CAPTURE		93.65%*	90.48%*	83.97%	93.70%

EW235

C-90

EW235 Alternate Location

Modeled Mass Capture

With C-400 Well (Scenario 3)	Without C-400 Well (Scenario 2)
93.70%	83.97%

Difference between Alternate Location and Modeled Location

With C-400 Well (Scenario 3)	Without C-400 Well (Scenario 2)
+0.05%	-6.51%



THIS PAGE INTENTIONALLY LEFT BLANK

APPENDIX D

**NORTHEAST PLUME OPTIMIZATION
QUALITY ASSURANCE PROJECT PLAN**

THIS PAGE INTENTIONALLY LEFT BLANK

CONTENTS

QAPP WORKSHEETS	D-3
ACRONYMS	D-5
INTRODUCTION	D-7

QAPP WORKSHEETS

QAPP Worksheets #1 and #2. Title and Approval Page.....	D-8
QAPP Worksheets #3 and #5. Project Organization and QAPP Distribution	D-13
QAPP Worksheet #5-A. Project Level Organizational Chart.....	D-14
QAPP Worksheet #4. Project Personnel Sign-Off Sheet: Sample Collection, Data Analysis, Data Validation.....	D-15
QAPP Worksheet #7. Personnel Responsibility and Qualifications Table	D-16
QAPP Worksheet #8. Special Personnel Training Requirements Table.....	D-17
QAPP Worksheet #6. Communication Pathways	D-18
QAPP Worksheet #9. Project Scoping Session Participant Sheet	D-20
QAPP Worksheet #10. Problem Definition	D-21
QAPP Worksheet #11. Project Quality Objectives/Systematic Planning Process Statements	D-24
QAPP Worksheet #12-K. Measurement Performance Criteria.....	D-25
QAPP Worksheet #12-Q. Measurement Performance Criteria.....	D-26
QAPP Worksheet #13. Secondary Data Criteria and Limitations Table	D-27
QAPP Worksheet #14. Summary of Project Tasks.....	D-28
QAPP Worksheet #16. Project Schedule/Timeline Table.....	D-29
QAPP Worksheet #15-A. Project Action Limits Laboratory-Specific Detection/Quantitation Limits	D-30
QAPP Worksheet #15-D. Project Action Limits Laboratory-Specific Detection/Quantitation Limits	D-31
QAPP Worksheet #15-K. Project Action Limits Laboratory-Specific Detection/Quantitation Limits	D-32
QAPP Worksheet #17-A. Sampling Design and Rationale (Northeast Plume Optimization).....	D-33
QAPP Worksheet #17-B. Groundwater Field Parameters	D-35
QAPP Worksheet #18. Sampling Locations and Methods/Standard Operating Procedure Requirements Table for Screening Samples	D-36
QAPP Worksheet #19. Analytical SOP Requirements Table	D-43
QAPP Worksheet #30. Analytical Services Table	D-44
QAPP Worksheet #20. Field Quality Control Sample Summary Table	D-45
QAPP Worksheet #21. Project Sampling SOP References Table	D-46
QAPP Worksheet #22. Field Equipment Calibration, Maintenance, Testing, and Inspection Table	D-48
QAPP Worksheet #23. Analytical SOP References Table	D-49
QAPP Worksheet #24. Analytical Instrument Calibration Information	D-50
QAPP Worksheet #25. Analytical Instrument and Equipment Maintenance, Testing, and Inspection Table.....	D-51
QAPP Worksheet #26. Sample Handling System.....	D-52
QAPP Worksheet #27. Sample Custody Requirements.....	D-53
QAPP Worksheet #28. QC Samples Table	D-54

QAPP Worksheet #29. Project Documents and Records Table..... D-57
QAPP Worksheet #31. Planned Project Assessments Table D-58
QAPP Worksheet #32. Assessment Findings and Corrective Action Responses D-59
QAPP Worksheet #33. QA Management Reports Table D-60
QAPP Worksheet #34. Verification (Step I) Process Table D-61
QAPP Worksheet #35. Assessment, Verification, and Validation (Steps IIa and IIb) Process Table D-62
QAPP Worksheet #36. Validation (Steps IIa and IIb) Summary Table..... D-63
QAPP Worksheet #37. Usability Assessment..... D-64

ACRONYMS

CA	corrective action
CAS	Chemical Abstracts Service
CERCLA	Comprehensive Environmental Response, Compensation, and Liability Act
COPC	chemical of potential concern
CRQL	contract-required quantitation limit
DOE	U.S. Department of Energy
DOECAP	DOE Consolidated Audit Program
DQI	data quality indicator
DQO	data quality objective
ECD	electron capture detector
EDD	Electronic Data Deliverable
EPA	U.S. Environmental Protection Agency
EW	extraction well
FFA	Federal Facility Agreement
FID	flame ionization detector
FPDP	Fluor Federal Services, Inc., Paducah Deactivation Project
GC	gas chromatography
GC-MS	gas chromatography mass spectrometer
KDEP	Kentucky Department for Environmental Protection
LRGA	Lower Regional Gravel Aquifer
LSRS	LATA-Sharp Remediation Services, LLC
MCL	maximum contaminant level
MDA	minimum detectable activity
MDL	method detection limit
MRGA	Middle Regional Gravel Aquifer
MOA	Memorandum of Agreement
MS	matrix spike
MW	monitoring well
N/A	not applicable
NAL	no action level
NEPCS	Northeast Plume Containment System
OREIS	Paducah Oak Ridge Environmental Information System
PEGASIS	Portsmouth/Paducah Project Office Environmental Geographic Analytical Spatial Information System
PGDP	Paducah Gaseous Diffusion Plant
PQL	practical quantitation limit
PZ	piezometer
QA	quality assurance
QAPP	Quality Assurance Project Plan
QC	quality control
RAWP	Remedial Action Work Plan
RGA	Regional Gravel Aquifer
RPD	relative percent difference
SOP	standard operating procedure
TBD	to be determined
UFP	Uniform Federal Policy
URGA	Upper Regional Gravel Aquifer
VOC	volatile organic compound

THIS PAGE INTENTIONALLY LEFT BLANK

INTRODUCTION

The Northeast Plume Optimization project-specific Quality Assurance Project Plan (QAPP) has been prepared by Fluor Federal Services, Inc., Paducah Deactivation Project (FPDP) based on the programmatic QAPP, DOE/LX/07/1269&D2/R1, *Programmatic Quality Assurance Project Plan* (DOE 2013), as updated (DOE 2015; 2016), which was based on the *Uniform Federal Policy for Quality Assurance Project Plans* (UFP-QAPP Manual) guidelines for QAPPs (IDQTF 2005), and the updated *Optimized UFP-QAPP Worksheets* guidance (IDQTF 2012).

This QAPP will be included as Appendix D to the *Remedial Action Work Plan for Optimization of the Northeast Plume Interim Remedial Action at the Paducah Gaseous Diffusion Plant, Paducah, Kentucky*, DOE/LX/07-1280&D2/R2/A1. It describes the project-specific quality assurance activities that will be conducted to support monitoring and operation of the Northeast Plume Optimization Project.

This Northeast Plume Optimization QAPP does the following:

- Refers to the standard operating procedures (SOPs) already developed for the site and in place;
- Identifies analytical limits, units of reporting, and required methods (e.g., permits, maximum contaminant level (MCL), etc.); these values will be used to procure laboratory services. If the laboratory cannot meet the limits, units, or methods specified in the QAPP, the project manager and/or compliance organization will be contacted so a determination can be made if the proposed conditions are acceptable to meet current project objectives. If the conditions are found to be acceptable, the Sample Management Office will document the acceptance with rationale;
- Incorporates the *Data and Documents Management and Quality Assurance Plan for Paducah Environmental Management and Enrichment Facilities*, DOE/OR/07-1595&D2 (DOE 1998); and
- Standardizes data validation processes by linking the process to SOPs (see Worksheet #21).

This document supports *Explanation of Significant Differences to the Record of Decision for the Interim Remedial Action of the Northeast Plume at the Paducah Gaseous Diffusion Plant Paducah, Kentucky*, DOE/LX/07-1291&D2/R2, (DOE 2015) and *Remedial Action Work Plan for Optimization of the Northeast Plume Interim Remedial Action at the Paducah Gaseous Diffusion Plant, Paducah, Kentucky*, DOE/LX/07-1280&D2/R2 (DOE 2016) (RAWP).

Title: QAPP for Northeast Plume Optimization Project, Paducah Gaseous Diffusion Plant
Revision Number: 0
Revision Date: 4/2016

QAPP Worksheets #1 and #2. Title and Approval Page

Site Name/Project Name: Paducah Gaseous Diffusion Plant (PGDP)

Site Location: Paducah, Kentucky
Site Number/Code: KY8890008982
Contractor Name: FPDP
Contractor Number: Task Order: DE-DT0007774
Contract Title: Paducah Gaseous Diffusion Plant Paducah Deactivation Project
Work Assignment Number: N/A

Document Title: *Northeast Plume Optimization Quality Assurance Project Plan*

Lead Organization: U.S. Department of Energy (DOE)

Preparer's Name and Organizational Affiliation: Todd Powers, Fluor Federal Services, Inc., Paducah Deactivation Project (FPDP)

Preparer's Address, Telephone Number, and E-mail Address: 5511 Hobbs Road, Kevil, KY, 42053
Phone (270) 441-5791, todd.powers@ffspaducah.com

Preparation Date (Month/Year): 4/2016

Document Control Number: DOE/LX/07-1280&D2/R2/A1, Appendix D

FPDP Signature:  _____
Mark J. Duff
Environmental Management, Director

Date: 4-25-16

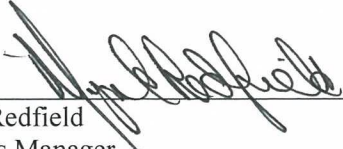
FPDP Signature:  _____
Myrna Espinosa Redfield
Regulatory Affairs Manager

Date: 4/25/16

FPDP Signature:  _____
Lisa Crabtree
Environmental Monitoring Project Manager

Date: 4/25/16

FPDP Signature:  _____
Jim Quinnette
QA Manager

Date: 4/25/16

QAPP Worksheets #1 and #2. Title and Approval Page (Continued)

1. Identify guidance used to prepare QAPP:

Intergovernmental Data Quality Task Force, March 2005. *The Uniform Federal Policy for Implementing Environmental Quality Systems*, Version 2.0, 126 pages.

Intergovernmental Data Quality Task Force, March 2005. *The Uniform Federal Policy for Quality Assurance Project Plans: Part 1 UFP QAPP Manual*, Version 1.0, 177 pages (DTIC ADA 427785 or EPA-505-B-04-900A).

Intergovernmental Data Quality Task Force, March 2005. *The Uniform Federal Policy for Quality Assurance Project Plans: Part 2A UFP QAPP Worksheets*, Version 1.0, 44 pages.

Intergovernmental Data Quality Task Force, March 2005. *The Uniform Federal Policy for Quality Assurance Project Plans: Part 2B Quality Assurance/Quality Control Compendium: Minimum QA/QC Activities*, Version 1.0, 76 pages.

Intergovernmental Data Quality Task Force, March 2012. *Uniform Federal Policy for Quality Assurance Project Plans, Optimized UFP QAPP Worksheets*, 42 pages.

Paducah Gaseous Diffusion Plant Programmatic Quality Assurance Project Plan, DOE/LX/07-1269&D2/R2, March 2015, 352 pages.

2. Identify regulatory program: Comprehensive Environmental Response, Compensation, and Liability Act (CERCLA); *Federal Facility Agreement for the Paducah Gaseous Diffusion Plant*, DOE/OR/07-1707 (FFA); Kentucky Department for Environmental Protection (KDEP) (Kentucky Division of Waste Management, Kentucky Division of Water); and DOE Orders.

3. Identify approval entity: DOE

4. Indicate whether the QAPP is a generic or a project-specific QAPP (circle one).

5. List dates of scoping sessions that were held: Data Quality Objectives (DQO) as documented in *Operation and Maintenance Plan for the Northeast Plume Containment System Interim Remedial Action at the Paducah Gaseous Diffusion Plant, Paducah, Kentucky*, DOE/OR/07-1535&D3/R4, August 2013

Senior Executive Committee Dispute Resolution Memorandum of Agreement as documented in MEMORANDUM OF AGREEMENT FOR RESOLUTION of Formal Dispute of the Explanation of Significant Differences to the Record of Decision for the Interim Remedial Action of the Northeast Plume at the Paducah Gaseous Diffusion

Title: QAPP for Northeast Plume Optimization Project, Paducah Gaseous Diffusion Plant

Revision Number: 0

Revision Date: 4/2016

Plant, Paducah, Kentucky (DOE/LX/07-1291&D2), and Remedial Action Work Plan for Optimization of the Northeast Plume Interim Remedial Action at the Paducah Gaseous Diffusion Plant, Paducah, Kentucky, DOE/LX/07-1280&D2, July 2015

WebEx Scoping Session—DQO discussions related to proposed monitoring well network held between DOE, EPA, KDEP, and LATA-Sharp Remediation Services, LLC (LSRS) representatives, September 15, 2015.

WebEx Scoping Session—Discussions held between DOE, EPA, KDEP, and LSRS representatives to review EPA and KDEP conditions to the Northeast Plume Optimization's Remedial Action Work Plan (RAWP), December 14 and 15, 2015.

QAPP Worksheets #1 and #2. Title and Approved Page (Continued)

6. List dates and titles of QAPP documents written for previous site work, if applicable:

Title:	Approval Date:
<i>Data and Documents Management and Quality Assurance Plan for Paducah Environmental Management and Enrichment Facilities, DOE/OR/07-1595&D2 (DOE 1998)</i>	10/5/1998
<i>Work Plan for the Soils Operable Unit Remedial Investigation/Feasibility Study at the Paducah Gaseous Diffusion Plant, Paducah, Kentucky, DOE/LX/07-0120&D2/R2</i>	10/10/2010 (EPA)
<i>Addendum to the Work Plan for the Burial Grounds Operable Unit Remedial Investigation/Feasibility Study at the Paducah Gaseous Diffusion Plant, Paducah, Kentucky, Solid Waste Management Unit 4 Sampling and Analysis Plan, DOE/OR/07-2179&D2/A2/R3</i>	8/29/2014 (EPA)
<i>Sitewide Evaluation Work Plan for Anomalies Located Outside the Limited Area at the Paducah Gaseous Diffusion Plant Paducah, Kentucky, DOE/LX/07-1288&D2</i>	9/19/2014 (EPA)

7. List organizational partners (stakeholders) and connection with lead organization:
 U.S. Environmental Protection Agency (EPA) Region 4 (FFA member), KDEP (Regulates hazardous and solid waste landfills, effluent discharge permits, FFA member), DOE (Lead Organization), FPDP (DOE Prime Contractor)
8. List data users: DOE, FPDP, EPA Region 4, Commonwealth of Kentucky
9. This QAPP includes 28 worksheets that are required based on UFP-QAPP guidance.

Title: QAPP for Northeast Plume Optimization
Project, Paducah Gaseous Diffusion Plant
Revision Number: 0
Revision Date: 4/2016

Table 1. Crosswalk: UFP-QAPP Workbook to 2106-G-05-QAPP

Optimized UFP-QAPP Worksheets		CIO 2106-G-05 QAPP Guidance Section	
1 & 2	Title and Approval Page	2.2.1	Title, Version, and Approval/Sign-Off
3 & 5	Project Organization and QAPP Distribution	2.2.3	Distribution List
		2.2.4	Project Organization and Schedule
4, 7, & 8	Personnel Qualifications and Sign-off Sheet	2.2.1	Title, Version, and Approval/Sign-Off
		2.2.7	Special Training Requirements and Certification
6	Communication Pathways	2.2.4	Project Organization and Schedule
9	Project Planning Session Summary	2.2.5	Project Background, Overview, and Intended Use of Data
10	Conceptual Site Model	2.2.5	Project Background, Overview, and Intended Use of Data
11	Project/Data Quality Objectives	2.2.6	Data/Project Quality Objectives and Measurement Performance Criteria
12	Measurement Performance Criteria	2.2.6	Data/Project Quality Objectives and Measurement Performance Criteria
13	Secondary Data Uses and Limitations	Chapter 3	QAPP ELEMENTS FOR EVALUATING EXISTING DATA
14 & 16	Project Tasks and Schedule	2.2.4	Project Organization and Schedule
15	Project Action Limits and Laboratory-Specific Detection/Quantitation Limits	2.2.6	Data/Project Quality Objectives and Measurement Performance Criteria
17	Sampling Design and Rationale	2.3.1	Sample Collection Procedure, Experimental Design, and Sampling Tasks
18	Sampling Locations and Methods	2.3.1	Sample Collection Procedure, Experimental Design, and Sampling Tasks
		2.3.2	Sampling Procedures and Requirements
19 & 30	Sample Containers, Preservation, and Hold Times	2.3.2	Sampling Procedures and Requirements
20	Field QC	2.3.5	Quality Control Requirements
21	Field SOPs	2.3.2	Sampling Procedures and Requirements
22	Field Equipment Calibration, Maintenance, Testing, and Inspection	2.3.6	Instrument/Equipment Testing, Calibration and Maintenance Requirements, Supplies and Consumables
23	Analytical SOPs	2.3.4	Analytical Methods Requirements and Task Description
24	Analytical Instrument Calibration	2.3.6	Instrument/Equipment Testing, Calibration and Maintenance Require
25	Analytical Instrument and Equipment Maintenance, Testing, and Inspection	2.3.6	Instrument/Equipment Testing, Calibration and Maintenance Requirements, Supplies and Consumables
26 & 27	Sample Handling, Custody, and Disposal	2.3.3	Sample Handling, Custody Procedures, and Documentation
28	Analytical Quality Control and Corrective Action	2.3.5	Quality Control Requirements
29	Project Documents and Records	2.2.8	Documentation and Records Requirements
31, 32, & 33	Assessments and Corrective Action	2.4	Assessments and Data Review
		2.5.5	Reports to Management
34	Data Verification and Validation Inputs	2.5.1	Data Verification and Validation Targets and Methods
35	Data Verification Procedures	2.5.1	Data Verification and Validation Targets and Methods
36	Data Validation Procedures	2.5.1	Data Verification and Validation Targets and Methods
37	Data Usability Assessment	2.5.2	Quantitative and Qualitative Evaluations of Usability
		2.5.3	Potential Limitations on Data Interpretation
		2.5.4	Reconciliation with Project Requirements

**QAPP Worksheets #3 and #5.
Project Organization and QAPP Distribution**

Distribution is based on the position title. A change in the individual within an organization will not trigger a resubmittal of the QAPP. DOE may choose to update the sheet and submit changes to the document holders. These managers will be responsible for distribution of this QAPP, to their staff.

Controlled copies of the QAPP will be distributed according to the distribution list below. This list will be updated, as needed, and kept by the FPDP Records Management Department. Each person receiving a controlled copy also will receive any updates/revisions. If uncontrolled copies are distributed, it will be the responsibility of the person distributing the uncontrolled copy to provide updates/revisions.

Position Title	Organization	QAPP Recipients	Current Telephone Number	Current E-mail Address	Document Control Number
Paducah Site Lead	DOE	Jennifer Woodard	(270) 441-6820	jennifer.woodard@lex.doe.gov	1
Project Manager	DOE	David Dollins	(270) 441-6819	dave.dollins@lex.doe.gov	2
FFA Manager	DOE	Tracey Duncan	(270) 441-6862	tracey.duncan@lex.doe.gov	3
Director of Environmental Management	FPDP	Mark Duff	(270) 441-6127	mark.duff@ffspaducah.com	4
Regulatory Affairs Manager	FPDP	Myrna Redfield	(270) 441-5113	myrna.redfield@ffspaducah.com	5
Project Manager	FPDP	Craig Jones	(270) 441-5114	craig.jones@ffspaducah.com	6
Environmental Radiation Protection and Risk Assessment Manager	FPDP	LeAnne Garner	(270) 441-5436	leanne.garner@ffspaducah.com	7
FFA Manager	FPDP	Jana White	(270) 441-5185	jana.white@ffspaducah.com	8
QA Manager	FPDP	Jim Quinnette	(270) 441-5656	jim.quinnette@ffspaducah.com	9
Northeast Plume Optimization Project Manager	FPDP	Todd Powers	(270) 441-5791	todd.powers@ffspaducah.com	10
Environmental Monitoring Project Manager	FPDP	Lisa Crabtree	(270) 441-5135	lisa.crabtree@ffspaducah.com	11
Health and Safety Manager	FPDP	Steve Wentzel	(270) 441-6239	steve.wentzel@ffspaducah.com	12
Regulatory Compliance Manager	FPDP	Michael Gerle	(270) 441-6680	michael.gerle@ffspaducah.com	13
Senior Remedial Project Manager and FFA Manager	U.S. EPA, Region 4, Federal Facilities Branch	Julie Corkran	(404) 562-8547	corkran.julie@epa.gov	14
Division of Waste Management, Hazardous Waste Branch, PGDP Section Supervisor and FFA Manager	KDEP	Brian Begley	(502) 564-6716, ext 4641	brian.begley@ky.gov	15

**QAPP Worksheet #5-A.
Project Level Organizational Chart**

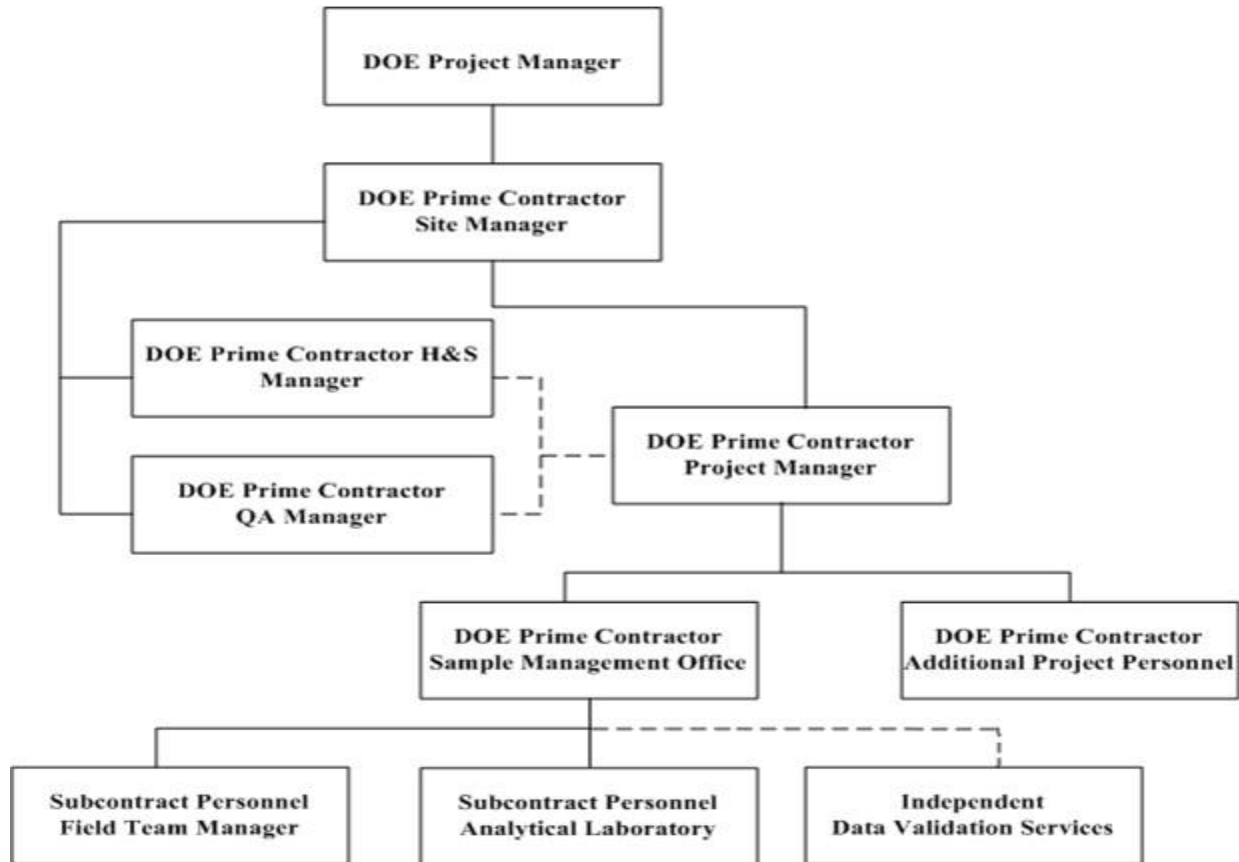

**QAPP Worksheet #4.
Project Personnel Sign-Off Sheet: Sample Collection, Data Analysis, Data Validation**

Personnel actively engaged in sample collection, data analysis, and data validation for the projects are required to read applicable sections of this QAPP and sign a Personnel Sign-off Sheet. The master list of signatures will be kept by the Northeast Plume Optimization Project Manager (or designee) and will be made available upon request.

Project Position Title	Organization	Specialized Training/Certification, if any	Signature	Date
Sample Team Leads	GEO Consultants	Per TPD		
Sample Management Office Manager	FPDP	Per TPD		
Independent Third-Party Data Validator	Los Alamos Technical Associates, Ohio	Bachelor degree plus relevant experience		
Environmental Radiation Protection and Risk Assessment Manager	FPDP	Per TPD		

N/A = not applicable
TPD = Training Position Description

**QAPP Worksheet #7.
Personnel Responsibility and Qualifications Table**

ORGANIZATION: FPDP

Name	Position Title Responsible	Organization Affiliation	Responsibilities	Education and Experience Qualifications¹
Craig Jones	Project Manager	FPDP	Overall project responsibility	> 4 years relevant work experience
Myrna Redfield	Regulatory Affairs Manager	FPDP	Project environmental compliance responsibility	Bachelor degree plus > 4 years work experience
Jana White	FFA Manager	FPDP	Project compliance with the FFA	> 4 years work relevant experience
Todd Powers	Northeast Plume Optimization Project Manager	FPDP	Northeast Plume Optimization Project responsibility	> 4 years relevant work experience
Lisa Crabtree	Environmental Monitoring Project Manager	FPDP	Support project on sampling, data management, and reporting activities	> 4 years relevant work experience
Darren Tinsley	Health and Safety Representative	FPDP	Project safety and health responsibility	Bachelor degree plus > 1 year relevant experience
Mike Zeiss	Waste Coordinator	FPDP	Overall project waste management responsibility	> 4 years relevant experience
James Moore	Data Validator	Los Alamos Technical Associates, Inc.	Performing data validation according to specified procedures	Bachelor degree plus relevant experience
TBD	Analytical Laboratory Project Manager	TBD	Sample analysis and data reporting	Bachelor degree plus relevant experience

TBD = to be determined

¹ Candidates who do not have a certificate or required degree but demonstrate additional “equivalent relevant work experience” can be considered when evaluating qualifications. This assessment will be conducted by the PM as he/she assembles the appropriate team for the project.

**QAPP Worksheet #8.
Special Personnel Training Requirements Table**

Personnel are trained in the safe and appropriate performance of their assigned duties in accordance with requirements of work to be performed. This QAPP has been developed as a generalized quality plan. There are no special training requirements other than what normally is required for work at the PGDP site. QAPP development uses a graded approach.

Project Function	Specialized Training— Title or Description of Course	Training Provider	Training Date	Personnel/Groups Receiving Training	Personnel Titles/ Organizational Affiliation	Location of Training Records/Certificates*
Project Tasks	There will be no specialized training required for this program other than what normally is required for site work at PGDP. The contractor will evaluate specific tasks and personnel will be assigned training as necessary to perform those tasks. Training may address health and safety aspects of specific tasks as well as contractor-specific, site-specific, and task-specific requirements.	FPDP	Prior to Monitoring	Based upon required duties	FPDP staff, subcontractors	Training files are maintained by the FPDP training organization. A training database is utilized to manage and track training.

*Training records are maintained by the FPDP training department. If training records and/or certificates do not exist or are not available, then this should be noted.

**QAPP Worksheet #6.
Communication Pathways**

NOTE: Forms of communication can include letter, e-mail, meetings, etc., and will occur throughout the project.

Communication Drivers	Organizational Affiliation	Position Title Responsible	Procedure
FFA, DOE/OR/07-1707	DOE Paducah Site Lead	Paducah Site Lead	All formal communication among DOE, EPA, and KDEP.
FFA, DOE/OR/07-1707	DOE Paducah	DOE Project Manager	All formal communication between DOE and contractor for Environmental Remediation Projects.
Project requirements	FPDP	Director of Environmental Management	All formal communication among the project, the Site Lead, and the DOE Project Manager.
Project requirements	FPDP	Project Manager	All communication between the project and the FPDP Director of Environmental Management.
Project Quality Assurance (QA) requirements	FPDP	Quality Manager	All project quality-related communication between the QA department and FPDP project personnel.
FFA compliance	FPDP	Regulatory Affairs Manager	All internal communication regarding FFA compliance with the FPDP Project Manager.

QAPP Worksheet #6. (Continued)
Communication Pathways

Communication Drivers	Organizational Affiliation	Position Title Responsible	Organizational Department Manager	Procedure
Project Requirements	FPDP	Northeast Plume Optimization Project Manager	Northeast Plume Optimization Project	All internal communication regarding project sample requirements.
Sampling Requirements	FPDP	Sample Team Leads	Environmental Monitoring	All internal communication regarding field sampling with the FPDP Project Manager.
Analytical Laboratory Interface	FPDP	Scientist	Environmental Monitoring	All communication between FPDP and analytical laboratory.
Waste Management Requirements	FPDP	Waste Coordinator	Waste Management	All internal communication regarding project waste management with FPDP Project Manager.
Environmental Compliance Requirements	FPDP	Regulatory Compliance Manager	Regulatory Affairs Manager	All internal correspondence regarding environmental requirements and compliance with the FPDP Project Manager.
Subcontractor Requirements (if applicable)	FPDP	Subcontract Administrator	Business Manager	All correspondence between the project and subcontractors, if applicable.
Health and Safety Requirements	FPDP	Health and Safety Representative	Health and Safety Manager	All internal communication regarding safety and health requirements with the FPDP Project Manager.

**QAPP Worksheet #9.
Project Scoping Session Participant Sheet**

Project scoping is the key to the success of any project and is part of the systematic planning process. The scoping that supports this QAPP are the numerous meetings culminating in the *MEMORANDUM OF AGREEMENT FOR RESOLUTION of Formal Dispute of the Explanation of Significant Differences to the Record of Decision for the Interim Remedial Action of the Northeast Plume at the Paducah Gaseous Diffusion Plant, Paducah, Kentucky (DOE/LX/07-1291&D2), and Remedial Action Work Plan for Optimization of the Northeast Plume Interim Remedial Action at the Paducah Gaseous Diffusion Plant, Paducah, Kentucky, DOE/LX/07-1280&D2, July 2015*

WebEx Scoping Session—DQO discussions related to proposed monitoring well network held among DOE, EPA, KDEP, and LSRS representatives, September 15, 2015.

WebEx Scoping Session—Discussions held among DOE, EPA, KDEP, and LSRS representatives to review EPA and KDEP conditions to the Northeast Plume Optimization Remedial Action Work Plan (RAWP), December 14 and 15, 2015.

**QAPP Worksheet #10.
Problem Definition**

The problem to be addressed by the project: Trichloroethene (TCE) concentrations in groundwater persist within the plant boundary and have migrated beyond the plant boundary at concentrations above the Safe Drinking Water Standards.

The environmental questions being asked: What is the percent mass capture of the optimized extraction well (EW) system?

Is operation of the EW system causing or contributing to undesired migration of technetium-99 (Tc-99) contamination from the source areas(s) (e.g., C-400 Building and Northwest Plume)?

The following data gaps² have been identified:

1. Is the Northeast Plume Containment System retarding the migration of the highest concentration volume of the TCE groundwater plume?
2. Is the treatment system (air stripper) effectively stripping TCE from the contaminated groundwater?
3. Is the treatment system affecting environmental performance at the CERCLA Outfall 001?
4. What levels of TCE are being discharged into the atmosphere from the groundwater extraction process?
5. Is the Northeast Plume Containment System meeting the requirements stated in the Facility and Nuclear Safety evaluation?
6. Is the Northeast Plume Containment System running efficiently in terms of operation and maintenance?

Observations from any site reconnaissance reports: Biannual updates to Paducah Site plume maps and as needed updates to the site groundwater model.

A synopsis of secondary data or information from site reports: The site plume maps identify two centroids of contamination within the Northeast Plume. In the area of the optimized EWs, TCE levels are not expected to exceed 600 µg/L and Tc-99 activity is not expected to exceed 200 pCi/L.³

The possible classes of contaminants and the affected matrices: The primary contaminant of concern is TCE. Other potential contaminants include 1,1-dichloroethene (DCE), and Tc-99.

The rationale for inclusion of chemical and nonchemical analyses: Worksheets #11 and #17 present rationale for inclusion of chemical and nonchemical analyses.

Information concerning various environmental indicators: Based on KDEP Environmental Indicator determination, contaminated groundwater migration currently is not considered to be under control at PGDP, under the Government Performance and Results Act.

² Table 3 of *Operation and Maintenance Plan for the Northeast Plume Containment System Interim Remedial Action at the Paducah Gaseous Diffusion Plant, Paducah, Kentucky*, DOE/OR/07-1535&D3/R4, August 2013.

³ The anticipated concentrations are based on over 15 years of TCE and Tc-99 data from 21 permanent monitoring wells. However, historical data from the 1997 WAG 6 Study reported elevated beta activity from a single sample location that was collected with a temporary open borehole. The sample was not analyzed for Tc-99.

QAPP Worksheet #10. (Continued)
Problem Definition

Project decision conditions (“If..., then...” statements):

1. If field data⁴ collected from the monitoring well (MW) network at the extraction field indicate that the EWs are not effectively retarding the migration of the highest concentration volume of the plume, then operation of the extraction field will be reevaluated and adjustments made as necessary. Otherwise, operation of the extraction field will continue at existing levels.
2. If TCE levels in discharge effluents at CERCLA Outfall 001 exceed 75% of the 30 µg/l discharge limit (22.5 µg/L), then operational conditions will be investigated and appropriate adjustments made as necessary. Otherwise, operation of the system will continue as outlined.
3. If any pollutant exceeds the CERCLA Outfall 001 discharge criteria, then the possible contributions to that exceedance by the Northeast Plume Containment System (NEPCS) will be investigated, and operations will be altered or suspended as necessary. Otherwise, operation of the system will continue as outlined.
4. If air emissions of TCE from the NEPCS, as a single source or as a contributor to site emissions, exceed the regulatory guidelines, then the operating status will be reviewed and revised as necessary. Otherwise, operation of the system will continue as outlined.
5. If TCE or Tc-99 levels exceed the levels used in assumptions serving as the basis for safety,⁵ environmental, or operating limiting conditions, then system operation will be suspended until the impacts can be evaluated and appropriate operating conditions can be reestablished. Otherwise, operation of the system will continue as outlined.
6. If system components are not operating within the manufacturer’s specified performance criteria, then system operation will be evaluated. Otherwise, operation of the NEPCS will continue as outlined.

D-22

⁴ Monitoring well groundwater sampling will be performed under the Northeast Plume Optimization Project. Frequencies and analytes are as follows:

- Every sampling event—depth to water, dissolved oxygen, pH, specific conductance, temperature, redox, and turbidity.
- Quarterly parameters—TCE; 1,1-DCE; Tc-99; and gross alpha and beta.

⁵ The current safety basis for the Northeast Plume Containment System is contained in the sitewide industrial preliminary hazard screening, PHS-PH-INDSTR-0067/R2, February 2014. This document assumes the maximum concentration for TCE (at the system inlet) is 3,600 µg/L, and the maximum activity for Tc-99 is the MCL for Tc-99 (900 pCi/L).

QAPP Worksheet #10. (Continued)
Problem Definition

Additional project decision conditions (“If..., then...” statements) identified in the 2015 Memorandum of Agreement for Resolution:⁶

7. The anticipated contaminant concentrations of Tc-99 and TCE in the transect monitoring wells are expected to be no higher than 200 pCi/L and 600 µg/L, respectively. If baseline contaminant concentrations in any of the transect monitoring wells during the initial quarterly sampling are detected at twice the anticipated contaminant concentrations, then the FFA parties agree to temporarily suspend start-up of the extraction wells until the parties meet to evaluate the identified discrepancy, its potential impact on the NW Plume source actions and the planned NE Plume optimization project.
8. If contaminant concentrations in any transect⁷ well’s quarterly samples are determined to be increasing and may double above the established baseline within a year of the quarterly samples showing an increase, then potential changes in groundwater flow or source impacts (e.g. rising contaminant concentrations in the NE Plume, source migration, etc.) will be further examined and the FFA parties will consider adjustments (e.g. adjusting extraction well pumping rates) for the optimized NE Plume interim action to minimize these potential impacts.
9. If the measures taken by the FFA parties (e.g. adjusting extraction well pumping rates) do not result in decreased or stabilized concentrations at the transect monitoring wells, or if such adjustments reduce the effectiveness of the optimized extraction wells or if Tc-99 concentrations continue to increase and are detected at twice their baseline concentration in any one (or more) of the transect wells for two consecutive quarters, then DOE must notify EPA and KDEP within 30 days of receiving sampling results or one of the aforementioned conditions occurring.
10. If FFA parties decide to implement a modification to the Interim Remedial Action to address the NE Plume contamination (including the expansion), then depending on the scope of the modifications it is possible that the FFA parties will decide to shut-down the optimized pump and treat system in part or in its entirety. If a determination is made to shut down the optimized pump and treat system either before a modification to the Interim Remedial Action or as part of a modification to the Interim Action, then DOE shall reinstate implementation of the NE Plume Interim Remedial Action (Interim ROD 1995).

D-23

⁶ *Memorandum of Agreement for Resolution of Formal Dispute of the Explanation of Significant Differences to the Record of Decision for the Interim Remedial Action of the Northeast Plume at the Paducah Gaseous Diffusion Plant, Paducah, Kentucky (DOE/LX/07-1291&D2), and Remedial Action Work Plan for Optimization of the Northeast Plume Interim Remedial Action at the Paducah Gaseous Diffusion Plant, Paducah, Kentucky (DOE/LX/07-1280&D2)*, U.S. Department of Energy, Paducah, KY, July 31, 2015.

⁷ The 2015 Memorandum of Agreement for Resolution required installation of a north-south transect of RGA monitoring wells approximately 600 ft east of C-400 Building.

QAPP Worksheet #11.
Project Quality Objectives/Systematic Planning Process Statements

This QAPP has been prepared to detail the minimum standards, particularly for field and analytical data quality. Analytical data will be generated by DOE Consolidated Audit Program (DOECAP) laboratories utilizing approved laboratory test methods. The overall project quality objectives are to develop and implement procedures for field sampling, chain-of-custody, laboratory analysis, and reporting that will provide results that are legally defensible in a court of law. Specific procedures for sampling, chain-of-custody, instrument calibration/preventive maintenance, chemical analysis, internal quality control (QC), reporting data, audits, and corrective actions are described in other sections of this QAPP.

Who will use the data? DOE, FPDP, Commonwealth of Kentucky, and EPA.

What will the data be used for? Data will be used for evaluation of Northeast Plume Optimization Project and will be reported via FFA semiannual reports.

What type of data is needed? Target analytes, analytical groups, field screening, on-site analytical or off-site laboratory techniques, sampling techniques. The required list of analytes is provided on Worksheet #23. The collection of groundwater field parameters and off-site laboratory analyses will be used for data collection. The target analytes include VOCs, Tc-99, gross alpha and beta activities, and general water quality parameters.

How “good” do the data need to be in order to support the environmental decision? Data need to meet the measurement quality objective and data quality indicators (DQIs) established by the systematic planning process consistent with procedure *Quality Assured Data*; CP3-ES-1003, *Developing, Implementing, and Maintaining Data Management Implementation Plans*; and Section 9 “Data Management and Implementation Plan” of the *Remedial Action Work Plan for Optimization of the Northeast Plume Interim Remedial Action at the Paducah Gaseous Diffusion Plant, Paducah, Kentucky*, DOE/LX/07-1280&D2/R2 (February 2016).

Where, when, and how should the data be collected/generated? In the EWs, pump rates are recorded daily, water levels are measured weekly, and TCE and Tc-99 samples are collected quarterly. Monitoring wells are sampled quarterly. The CERCLA Outfall 001 is sampled weekly for general water quality parameters and volatile organic compounds (VOCs), quarterly for chronic toxicity and Tc-99.

Who will collect and generate the data? FPDP. Additionally, meteorological data may be acquired from other sources (as needed).

How will the data be reported? Field data will be recorded on chain-of-custody forms, in field logbooks, and field data sheets. The fixed-base laboratory will provide data in an Electronic Data Deliverable (EDD). Project data following verification assessment and validation will be placed into and reported from the Paducah Oak Ridge Environmental Information System (OREIS). Data loaded into Paducah OREIS will be made available to the public stakeholders via the Portsmouth/Paducah Project Office Environmental Geographic Analytical Spatial Information System (PEGASIS).

How will the data be archived? Electronic data will be archived in OREIS in accordance with Section 8.5 (Data and Records Archival) of the *Data and Documents Management and Quality Assurance Plan* (DOE 1998).

**QAPP Worksheet #12-K.
Measurement Performance Criteria**

Matrix	Water/Groundwater and Surface Water				
Analytical Group ¹	VOC				
Concentration Level	Low				
Sampling Procedure ²	Analytical Method/SOP ^{3, 4}	DQIs	Measurement Performance Criteria	QC Sample and/or Activity Used to Assess Measurement Performance	QC Sample Assesses Error for Sampling (S), Analytical (A) or both (S&A)
CP4-ES-2101, <i>Groundwater Sampling</i> , and CP4-ES-2203, <i>Surface Water Sampling</i>	SW846-8260 and EPA-624	Precision—Lab	RPD ≤ 25%	Laboratory Duplicates	A
		Precision	RPD ≤ 25%	Field Duplicates	S
		Accuracy/Bias	% recovery ⁶	Laboratory Sample Spikes	A
		Accuracy/Bias Contamination	No target compounds > PQL	Method Blanks/Instrument Blanks	A
		Accuracy/Bias Contamination	No target compounds > PQL	Field Blanks	S
		Accuracy/Bias Contamination	No target compounds > PQL	Trip Blanks	S
		Accuracy/Bias Contamination	No target compounds > PQL	Equipment Rinseates	S
		Completeness ⁵	≥ 90%	Data Completeness Check	S&A

PQL = practical quantitation limit; RPD = relative percent difference

¹ If information varies within an analytical group, separate by individual analyte.

² See QAPP Worksheet #21.

³ See QAPP Worksheet #23.

⁴ The most current version of the method will be used.

⁵ Completeness is calculated as the number of samples planned to be collected divided by the number of sample results that were rejected.

⁶ Percent recovery is laboratory-specific, calculated from studies performed every six months. Percent recovery ranges will be provided in the laboratory data packages based on the most current study.

**QAPP Worksheet #12-Q.
Measurement Performance Criteria**

Matrix	Water/Groundwater and Surface Water				
Analytical Group ¹	Radionuclides (Tc-99)				
Concentration Level	Low				
Sampling Procedure ²	Analytical Method/SOP ^{3, 4}	DQIs	Measurement Performance Criteria	QC Sample and/or Activity Used to Assess Measurement Performance	QC Sample Assesses Error for Sampling (S), Analytical (A) or both (S&A)
CP4-ES-2101, <i>Groundwater Sampling</i> , and CP4-ES-2203, <i>Surface Water Sampling</i>	Liquid scintillation	Precision—Lab	RPD—≤ 25%	Laboratory Duplicates	A
		Precision	RPD—≤ 25%	Field Duplicates	S
		Accuracy/Bias	% recovery ⁶	Laboratory Sample Spikes	A
		Accuracy/Bias-Contamination	No target compounds > MDA	Method Blanks/Instrument Blanks	A
		Accuracy/Bias Contamination	No target compounds > MDA	Field Blanks	S
		Accuracy/Bias Contamination	No target compounds > MDA	Equipment Rinseates	S
		Completeness ⁵	≥ 90%	Data Completeness Check	S&A

MDA = minimum detectable activity

¹ If information varies within an analytical group, separate by individual analyte.

² See QAPP Worksheet #21.

³ See QAPP Worksheet #23.

⁴ The most current version of the method will be used.

⁵ Completeness is calculated as the number of samples planned to be collected divided by the number of sample results that were rejected.

⁶ Percent recovery is laboratory-specific, calculated from studies performed every six months. Percent recovery ranges will be provided in the laboratory data packages based on the most current study.

**QAPP Worksheet #13.
 Secondary Data Criteria and Limitations Table**

Secondary Data	Data Source (Originating Organization, Report Title, and Date)	Data Generator(s) (Originating Org., Data Types, Data Generation/Collection Dates)	How Data Will Be Used	Limitations on Data Use
OREIS Database	Various	Various	Data will be used to determine the nature and extent of outfall surface water quality and Northeast Plume groundwater contamination.	Data have been verified, assessed, and validated (if validation is required). Rejected data will not be used if there is sufficient time to resample and obtain a result that will not be rejected during validation. All data are assessed based on <i>Quality Assured Data</i> , CP3-ES-5003.
Historical Documentation	Various	Various	Information will be used as guidance on Northeast Plume groundwater contamination.	Information from historical documents will be limited to the available documentation as it relates to a specific project. Three-party FFA discussions will occur prior to the use of historical data. Use of historical data may be limited based on how long ago the data were collected and whether site conditions have changed since data collection.

**QAPP Worksheet #14.
Summary of Project Tasks***

Sampling Tasks: Collect samples to assess contaminant levels in extraction and MWs and treatment system equalization tank**, air stripper efficiency, and CERCLA Outfall 001 compliance.

Analysis Tasks: Analysis according to current version of standard methods as listed in Worksheet 12.

Quality Control Tasks: QC will be per QAPP worksheets as follows:

- QC samples—Worksheets #20 and #28
- Equipment calibration—Worksheets #22 and #24
- Data review/validation—Worksheets #34, #35, #36, and #37

Secondary Data: See Worksheet #13

Data Management Tasks: Data management will be per procedures CP3-ES-5007, *Data Management Coordination*; CP3-ES-1003, *Developing, Implementing, and Maintaining Data Management Implementation Plans*; and Section 9, “Data Management and Implementation Plan” of *Remedial Action Work Plan for Optimization of the Northeast Plume Interim Remedial Action at the Paducah Gaseous Diffusion Plant, Paducah, Kentucky*, DOE/LX/07-1280&D2/R2 and, by reference, Section 10, “Data Management and Implementation Plan” of *Remedial Action Work Plan for In Situ Source Treatment by Deep Soil Mixing of the Southwest Groundwater Plume Volatile Organic Source at the C-747-C Oil Landfarm (Solid Waste Management Unit 1) at the Paducah Gaseous Diffusion Plant, Paducah, Kentucky*, DOE/LX/07-1287&D2/A1.

Documentation and Records: Documentation and records will be per procedure CP3-RD-0010, *Records Management Process*.

Assessment/Audit Tasks: Assessments and audits will be per procedure CP3-QA-1003, *Management and Self Assessments*.

Data Review Tasks: Data review tasks, including selection of data sets for validation by a third-party independent validator(s), will be per procedure CP3-ES-5003, *Quality Assured Data*, and the Section 9, “Data Management and Implementation Plan” of the *Remedial Action Work Plan for Optimization of the Northeast Plume Interim Remedial Action at the Paducah Gaseous Diffusion Plant, Paducah, Kentucky*, DOE/LX/07-1280&D2/R2 (February 2016).

*It is understood that SOPs are DOE Prime Contractor specific.

**The equalization tank, is in reference to the existing pump-and-treat system arrangement. The reference to the equalization tank was retained because the existing pump-and-treat system will be operational until the new extraction wells come online and (if conditions warrant) may be resumed in the future.

**QAPP Worksheet #16.
Project Schedule/Timeline Table**

Activities	Organization	Dates (MM/DD/YY)		Deliverable	Deliverable Due Date
		Anticipated Date(s) of Initiation	Anticipated Date of Completion		
<p>Preoperational sampling of transect monitoring wells to characterize 4 quarters before start-up of optimization extraction wells.</p> <p>Routine sampling conducted throughout the period of the Northeast Plume Optimization Project.</p>	FPDP	<p>Preoperational transect monitoring well sampling will characterize 4 quarters before start-up of the optimization extraction wells.</p> <p>Performance monitoring ongoing after installation of extraction wells</p>	<p>The optimized Northeast Plume system will continue operating until one the following occurs:</p> <ul style="list-style-type: none"> • The FFA parties mutually agree to cease operations. • A CERCLA Five-Year Review determination supports ceasing operations, or • The record of decision associated with the Dissolved-Phase Plume supports ceasing operations. 	<p>Project data will be summarized in semiannual FFA reports.</p> <p>MOA Section 4 notifications.</p> <p>Remedial Action Completion Report (RACR)</p>	<p>The FFA semiannual reports are issued in April and October of each year.</p> <p>Pursuant to Section 4 criteria of the MOA, DOE will notify EPA and KDEP within 30 days after receiving sampling results, if Section 4 conditions occur.</p> <p>RACR—TBD</p>

**QAPP Worksheet #15-A.
 Project Action Limits Laboratory-Specific Detection/Quantitation Limits**

Matrix: Water
Analyte Group: VOCs

VOCs	CAS Number	Project Action Limit/NAL (µg/L)	Project Action Limit Reference ^a	Site COPC? ^b	Laboratory-Specific	
					PQLs (µg/L)	MDLs (µg/L)
1,1-Dichloroethene	75-35-4	7/0.171	MCL/NAL	Yes	1	0.3
Trichloroethene	79-01-6	5/0.281	MCL/NAL	Yes	1	0.3

CAS = Chemical Abstracts Service

MDL = method detection limit

NAL = no action level for groundwater for the child resident scenario from the Risk Methods Document (DOE 2015)

^aThis QAPP references the MCLs. The worksheet also lists the NALs established by the Risk Methods Document (DOE 2015)(i.e., the no action level for groundwater for the child resident scenario).

^b Analytes marked with COPC are from Table 2.1 of the Risk Methods Document (DOE 2015) and represent the list of chemicals, compounds, and radionuclides compiled from COPCs retained as contaminants of concern in risk assessments performed at PGDP between 1990 and 2008.

**QAPP Worksheet #15-D.
 Project Action Limits Laboratory-Specific Detection/Quantitation Limits**

Matrix: Water
Analytical Group: Radionuclides

Radionuclides	CAS Number	Project Action Limit (pCi/L)	Project Action Limit Reference ^a	Site COPC? ^b	Laboratory-Specific
					MDAs (pCi/L)
Technetium-99	14133-76-7	4 mRem/year-dose (900 pCi/L)	MCL (NAL)	Yes	15-25

^aThis QAPP references the MCLs. The worksheet also lists the NALs established by the Risk Methods Document (DOE 2015) (i.e., the no action level for groundwater for the child resident scenario).

^bAnalytes marked with COPC are from Table 2.1 of the Risk Methods Document (DOE 2015) and represent the list of chemicals, compounds, and radionuclides compiled from COPCs retained as contaminants of concern in risk assessments performed at PGDP between 1990 and 2008.

**QAPP Worksheet #15-K.
 Project Action Limits Laboratory-Specific Detection/Quantitation Limits**

Matrix: Surface
Analyte Group: CERCLA Outfall 001

Outfall Discharge Criteria with Effluent Limits	CAS Number	Project Action Limit	Site COPC? ^a	Laboratory-Specific	
				PQLs	MDLs
Total Suspended Solids	N/A	30 mg/L	No	5 mg/L	1 mg/L
Oil and Grease	N/A	10 mg/L	No	7 mg/L	3.5 mg/L
1,1-Dichloroethene	75-35-4	7,100 µg/L	Yes	1 µg/L	0.3 µg/L
Trichloroethene	79-01-6	30 µg/L	Yes	1 µg/L	0.3 µg/L
Technetium-99	14133-76-7	N/A	Yes	N/A	15–25 pCi//L

^a Analytes marked with COPC (chemical of potential concern) are from Table 2.1 of the Risk Methods Document (DOE 2015) and represent the list of chemicals, compounds, and radionuclides compiled from COPCs retained as contaminants of concern in risk assessments performed at PGDP between 1990 and 2008.

**QAPP Worksheet #17-A.
Sampling Design and Rationale (Northeast Plume Optimization)**

Describe and provide a rationale for choosing the sampling approach (e.g., grid system, biased statistical approach): The sampling approach was agreed to by FFA parties in the MOA.

Describe the sampling design and rationale in terms of which matrices will be sampled: A description of the analyses, methods, and the method detection limits should be provided. The choice of methods and method detection limits should be justified, especially regarding screening levels that will not be attained.

What analyses will be performed and at what analytical limits? See Worksheets #12 and #15.

Where are the sampling locations (including QC, critical, and background samples)? See Section 2 of the RAWP.

How many samples to be taken? Unknown, sampling will be ongoing until FFA parties agree to cease operations.

What is the sampling frequency (including seasonal considerations)? Refer to Worksheet #18 for details.

Describe and provide a rationale for choosing the sampling approach (e.g., grid system, judgmental statistical approach): The Optimization project will be conducted in to two phases.

Phase I will involve the installation of seven transect monitoring wells into the Regional Gravel Aquifer (RGA) and will be located approximately 600 ft east of the C-400 Building footprint. In addition, two piezometers (PZs) will be installed into the RGA adjacent to the two proposed extraction well locations. The transect monitoring wells will be sampled in accordance with guidelines established and agreed to in the MOA to establish background levels and the analytical data will be used to determine if Phase II will be initiated. Sieve analysis samples will be collected from the RGA formation from the Phase I PZ locations.

Phase II is contingent on results of groundwater analytical data collected after completion of Phase I. Phase II drilling program will commence approximately four months after completion of Phase I, pending approval by the FFA parties. Phase II will include the installation of seven additional MWs, six additional PZs, and the installation of two extraction wells. Phase II work scope includes twelve drilling location within the DOE restricted Limited Area and three drilling locations outside of the Limited Area.

QAPP Worksheet #17-A. (Continued)
Sampling Design and Rationale (Northeast Plume Optimization)

Describe the sampling design and rationale in terms of which matrices will be sampled: Groundwater samples will be collected from the monitoring wells from preselected depths in the RGA and will be analyzed for VOCs, Tc-99, and general water quality parameters (refer to Worksheet #18 for the number samples and analytical methods by depth).

What analyses will be performed and at what analytical limits? See Worksheets #12 and #15.

Standard Environmental Sampling: Total volatile organic analyte (VOA) analysis by SW-846, 8260 and radiological analysis by gross alpha and beta activity, and liquid scintillation; See Worksheet #15 for method detection limit.

Engineering and Design Sampling Groundwater Field Parameters: See worksheet 17-B for complete list and additional details.

Where are the sampling locations (including QC, critical, and background samples)? See Worksheet #18.

How many samples to be taken? This is an ongoing sampling program and will continue until FFA parties agree to cease operation per the MOA.

What is the sampling frequency (including seasonal considerations)? Monitoring wells will be sampled on a quarterly basis and CERCLA Outfall 001 will be sampled on a weekly basis. Refer to Section 2, Table 3 of the RAWP for more detail.

Title: QAPP for Northeast Plume Optimization
Project, Paducah Gaseous Diffusion Plant
Revision Number: 0
Revision Date: 4/2016

QAPP Worksheet #17-B.
Groundwater Field Parameters

Analysis	Media Type	# of Samples	Test/Analytical Method	PQL
DO	Water	Refer to Worksheet #18	Hach Quanta Hydrolab	0.2 mg/L
pH	Water	Refer to Worksheet #18	Hach Quanta Hydrolab	0.2 Std Units
Redox	Water	Refer to Worksheet #18	Hach Quanta Hydrolab	20 mV
Temperature	Water	Refer to Worksheet #18	Hach Quanta Hydrolab	+/- 0.1°C
Specific Conductance	Water	Refer to Worksheet #18	Hach Quanta Hydrolab	0.001 mS/cm
Turbidity	Water	Refer to Worksheet #18	Hach Quanta Hydrolab	1 NTU

QAPP Worksheet #18.*
Sampling Locations and Methods/Standard Operating Procedure Requirements Table for Screening Samples

Sampling Location/ ID Number	Matrix	Depth (units)	Analytical Group	Concentration Level	Number of Samples (Identify Field Duplicates)	Sampling SOP Reference ^a	Rationale for Sampling Location
CERCLA Outfall 001	Surface Water	Discharge pipe	Flow (mgd)	NA	1/Week	CP4-ES-2203	Assess System Performance
CERCLA Outfall 001	Surface Water	Discharge pipe	Total suspended solids (mg/L)	30/60 ^b	1/Week (Minimum of 5%)	CP4-ES-2203	Assess System Performance
CERCLA Outfall 001	Surface Water	Discharge pipe	Oil and grease (mg/L)	10/15 ^b	1/Week (Minimum of 5%)	CP4-ES-2203	Assess System Performance
CERCLA Outfall 001	Surface Water	Discharge pipe	Total residual chlorine (mg/L)	0.011/0.019 ^b	1/Week (Minimum of 5%)	CP4-ES-2203	Assess System Performance
CERCLA Outfall 001	Surface Water	Discharge pipe	Temperature (°F)	NA/89 ^b	1/Week	CP4-ES-2203	Assess System Performance
CERCLA Outfall 001	Surface Water	Discharge pipe	TCE (µg/L)	30/NA ^b	1/Week (Minimum of 5%)	CP4-ES-2203	Assess System Performance
CERCLA Outfall 001	Surface Water	Discharge pipe	Chronic toxicity (TUc)	NA/1.00 ^b	1/Quarter	CP4-ES-2203	Assess System Performance
CERCLA Outfall 001	Surface Water	Discharge pipe	Tc-99 (µCi/mL)	NA/NA	1/Quarter (Minimum of 5%)	CP4-ES-2203	Assess System Performance
CERCLA Outfall 001	Surface Water	Discharge pipe	pH	6/9	1/Week	CP4-ES-2203	Assess System Performance
CERCLA Outfall 001	Surface Water	Discharge pipe	1,1-DCE (µg/L)	7,100/NA ^b	1/Week (Minimum of 5%)	CP4-ES-2203	Assess System Performance
MW524 ^{d,e}	Groundwater	Middle Regional Gravel Aquifer (MRGA)	TCE (µg/L), Tc-99 (pCi/L), 1,1-DCE (µg/L)	1200/400/NA ^c	1/Quarter (Minimum of 5%)	CP4-ES-2101	Notification for Institution of Corrective Measures
			Field Parameters	NA			

^a Refer to RAWP Tables 3 and 4 and Figures 4, 5, 6, and 7 for more detail.

^a See Analytical SOP References Table (Worksheet #21).

^b Monthly average/daily maximum.

^c VOC and Rad concentration levels referenced from MOA.

^d Transect well location.

^e Proposed new well location.

QAPP Worksheet #18. (Continued)*

Sampling Location/ ID Number	Matrix	Depth (units)	Analytical Group	Concentration Level	Number of Samples (Identify Field Duplicates)	Sampling SOP Reference ^a	Rationale for Sampling Location
MW525 ^{d,e}	Groundwater	MRGA	TCE (µg/L), Tc-99 (pCi/L), 1,1-DCE (µg/L)	1200/400/NA ^c	1/Quarter (Minimum of 5%)	CP4-ES-2101	Notification for Institution of Corrective Measures
			Field Parameters	NA			
MW526 ^{d,e}	Groundwater	MRGA	TCE (µg/L), Tc-99 (pCi/L), 1,1-DCE (µg/L)	1200/400/NA ^c	1/Quarter (Minimum of 5%)	CP4-ES-2101	Notification for Institution of Corrective Measures
			Field Parameters	NA			
MW527 ^{d,e}	Groundwater	MRGA	TCE (µg/L), Tc-99 (pCi/L), 1,1-DCE (µg/L)	1200/400/NA ^c	1/Quarter (Minimum of 5%)	CP4-ES-2101	Notification for Institution of Corrective Measures
			Field Parameters	NA			
MW528 ^{d,e}	Groundwater	Lower Regional Gravel Aquifer (LRGA)	TCE (µg/L), Tc-99 (pCi/L), 1,1-DCE (µg/L)	1200/400/NA ^c	1/Quarter (Minimum of 5%)	CP4-ES-2101	Notification for Institution of Corrective Measures
			Field Parameters	NA			
MW529 ^{d,e}	Groundwater	LRGA	TCE (µg/L), Tc-99 (pCi/L), 1,1-DCE (µg/L)	1200/400/NA ^c	1/Quarter (Minimum of 5%)	CP4-ES-2101	Notification for Institution of Corrective Measures
			Field Parameters	NA			
MW530 ^{d,e}	Groundwater	LRGA	TCE (µg/L), Tc-99 (pCi/L), 1,1-DCE (µg/L)	1200/400/NA ^c	1/Quarter (Minimum of 5%)	CP4-ES-2101	Notification for Institution of Corrective Measures
			Field Parameters	NA			

* Refer to RAWP Tables 3 and 4 and Figures 4, 5, 6, and 7 for more detail.

^a See Analytical SOP References Table (Worksheet #21).

^b Monthly average/daily maximum.

^c VOC and Rad concentration levels referenced from MOA.

^d Transect well location.

^e Proposed new well location.

QAPP Worksheet #18. (Continued)*

Sampling Location/ ID Number	Matrix	Depth (units)	Analytical Group	Concentration Level	Number of Samples (Identify Field Duplicates)	Sampling SOP Reference ^a	Rationale for Sampling Location
MW531 ^e	Groundwater	LRGA	TCE (µg/L), Tc-99 (pCi/L), 1,1-DCE (µg/L)	Low	1/Quarter (Minimum of 5%)	CP4-ES-2101	Notification for Institution of Corrective Measures
			Field Parameters	NA			
MW533 ^e	Groundwater	LRGA	TCE (µg/L), Tc-99 (pCi/L), 1,1-DCE (µg/L)	Low	1/Quarter (Minimum of 5%)	CP4-ES-2101	Notification for Institution of Corrective Measures
			Field Parameters	NA			
MW536 ^e	Groundwater	MRGA	TCE (µg/L), Tc-99 (pCi/L), 1,1-DCE (µg/L)	Low	1/Quarter (Minimum of 5%)	CP4-ES-2101	Notification for Institution of Corrective Measures
			Field Parameters	NA			
MW537 ^e	Groundwater	LRGA	TCE (µg/L), Tc-99 (pCi/L), 1,1-DCE (µg/L)	Low	1/Quarter (Minimum of 5%)	CP4-ES-2101	Notification for Institution of Corrective Measures
			Field Parameters	NA			
MW538 ^e	Groundwater	MRGA	TCE (µg/L), Tc-99 (pCi/L), 1,1-DCE (µg/L)	Low	1/Quarter (Minimum of 5%)	CP4-ES-2101	Notification for Institution of Corrective Measures
			Field Parameters	NA			
MW539 ^e	Groundwater	LRGA	TCE (µg/L), Tc-99 (pCi/L), 1,1-DCE (µg/L)	Low	1/Quarter (Minimum of 5%)	CP4-ES-2101	Notification for Institution of Corrective Measures
			Field Parameters	NA			
MW556 ^e	Groundwater	LRGA	TCE (µg/L), Tc-99 (pCi/L), 1,1-DCE (µg/L)	Low	1/Quarter (Minimum of 5%)	CP4-ES-2101	Notification for Institution of Corrective Measures
			Field Parameter	NA			

* Refer to RAWP Tables 3 and 4 and Figures 4, 5, 6, and 7 for more detail.

^a See Analytical SOP References Table (Worksheet #21).

^b Monthly average/daily maximum.

^c VOC and Rad concentration levels referenced from MOA.

^d Transect well location.

^e Proposed new well location.

QAPP Worksheet #18. (Continued)*

Sampling Location/ ID Number	Matrix	Depth (units)	Analytical Group	Concentration Level	Number of Samples (Identify Field Duplicates)	Sampling SOP Reference ^a	Rationale for Sampling Location
EW234 ^e	Groundwater	RGA	TCE (µg/L), Tc-99 (µCi/mL)	Low	1/Month (Minimum of 5%)	CP4-ES-2101	Assess System Performance
EW235 ^e	Groundwater	RGA	TCE (µg/L), Tc-99 (µCi/ mL)	Low	1/Month (Minimum of 5%)	CP4-ES-2101	Assess System Performance
EW331	Groundwater	RGA	TCE (µg/L), Tc-99 (µCi/ mL)	Low	1/Month (Minimum of 5%)	CP4-ES-2101	Assess System Performance
EW332	Groundwater	RGA	TCE (µg/L), Tc-99 (µCi/ mL)	Low	1/Month (Minimum of 5%)	CP4-ES-2101	Assess System Performance
EQ Tank	Groundwater	System	TCE (µg/L), Tc-99 (µCi/ mL)	Low	1/Month (Minimum of 5%)	CP4-ES-2101	Assess System Performance
Air Stripper Effluent	Groundwater	System	TCE (µg/L)	Low	Weekly (Minimum of 5%)	CP4-ES-2101	Assess System Performance
MW144	Groundwater	LRGA	TCE (µg/L), Tc-99 (pCi/L), 1,1-DCE (µg/L)	Low	1/Quarter (Minimum of 5%)	CP4-ES-2101	Assess System Performance
			Field Parameter	NA			
MW145	Groundwater	Upper Regional Gravel Aquifer (URGA)	TCE (µg/L), Tc-99 (pCi/L), 1,1-DCE (µg/L)	Low	1/Quarter (Minimum of 5%)	CP4-ES-2101	Assess System Performance
			Field Parameter	NA			
MW258	Groundwater	LRGA	TCE (µg/L), Tc-99 (pCi/L), 1,1-DCE (µg/L)	Low	1/Quarter (Minimum of 5%)	CP4-ES-2101	Assess System Performance
			Field Parameter	NA			

^a Refer to RAWP Tables 3 and 4 and Figures 4, 5, 6, and 7 for more detail.

^b See Analytical SOP References Table (Worksheet #21).

^c Monthly average/daily maximum

^d VOC and Rad concentration levels referenced from MOA.

^e Transect well location.

^f Proposed new well location.

QAPP Worksheet #18. (Continued)*

Sampling Location/ID Number	Matrix	Depth (units)	Analytical Group	Concentration Level	Number of Samples (Identify Field Duplicates)	Sampling SOP Reference ^a	Rationale for Sampling Location
MW478	Groundwater	URGA	TCE (µg/L), Tc-99 (pCi/L), 1,1-DCE (µg/L)	Low	1/Quarter (Minimum of 5%)	CP4-ES-2101	Assess System Performance
			Field Parameter	NA			
MW479	Groundwater	URGA	TCE (µg/L), Tc-99 (pCi/L), 1,1-DCE (µg/L)	Low	1/Quarter (Minimum of 5%)	CP4-ES-2101	Assess System Performance
			Field Parameter	NA			
MW480	Groundwater	LRGA	TCE (µg/L), Tc-99 (pCi/L), 1,1-DCE (µg/L)	Low	1/Quarter (Minimum of 5%)	CP4-ES-2101	Assess System Performance
			Field Parameter	NA			
MW495	Groundwater	LRGA	TCE (µg/L), Tc-99 (pCi/L), 1,1-DCE (µg/L)	Low	1/Quarter (Minimum of 5%)	CP4-ES-2101	Assess System Performance
			Field Parameter	NA			
MW496	Groundwater	LRGA	TCE (µg/L), Tc-99 (pCi/L), 1,1-DCE (µg/L)	Low	1/Quarter (Minimum of 5%)	CP4-ES-2101	Assess System Performance
			Field Parameter	NA			

* Refer to RAWP Tables 3 and 4 and Figures 4, 5, 6, and 7 for more detail.

^a See Analytical SOP References Table (Worksheet #21).

^b Monthly average/daily maximum.

^c VOC and Rad concentration levels referenced from MOA.

^d Transect well location.

^e Proposed new well location.

QAPP Worksheet #18. (Continued)*

Sampling Location/ ID Number	Matrix	Depth (units)	Analytical Group	Concentration Level	Number of Samples (Identify Field Duplicates)	Sampling SOP Reference ^a	Rationale for Sampling Location
MW124	Groundwater	LRGA	TCE (µg/L), Tc-99 (pCi/L), 1,1-DCE (µg/L)	Low	1/Quarter (Minimum of 5%)	CP4-ES-2101	Protection of Human Health & Environment
			Field Parameter	NA			
MW126	Groundwater	MRGA	TCE (µg/L), Tc-99 (pCi/L), 1,1-DCE (µg/L)	Low	1/Quarter (Minimum of 5%)	CP4-ES-2101	Protection of Human Health & Environment
			Field Parameter	NA			
MW283	Groundwater	LRGA	TCE (µg/L), Tc-99 (pCi/L), 1,1-DCE (µg/L)	Low	1/Quarter (Minimum of 5%)	CP4-ES-2101	Protection of Human Health & Environment
			Field Parameter	NA			
MW288	Groundwater	LRGA	TCE (µg/L), Tc-99 (pCi/L), 1,1-DCE (µg/L)	Low	1/Quarter (Minimum of 5%)	CP4-ES-2101	Protection of Human Health & Environment
			Field Parameter	NA			
MW291	Groundwater	LRGA	TCE (µg/L), Tc-99 (pCi/L), 1,1-DCE (µg/L)	Low	1/Quarter (Minimum of 5%)	CP4-ES-2101	Protection of Human Health & Environment
			Field Parameter	NA			

* Refer to RAWP Tables 3 and 4, and Figures 4, 5, 6, and 7 for more detail.

^a See Analytical SOP References Table (Worksheet #21).

^b Monthly average/daily maximum.

^c VOC and Rad concentration levels referenced from MOA.

^d Transect well location.

^e Proposed new well location.

^f Proposed new well location

QAPP Worksheet #18. (Continued)*

Sampling Location/ ID Number	Matrix	Depth (units)	Analytical Group	Concentration Level	Number of Samples (Identify Field Duplicates)	Sampling SOP Reference ^a	Rationale for Sampling Location
MW292	GW	LRGA	TCE (µg/L), Tc-99 (pCi/L), 1,1-DCE (µg/L)	Low	1/Quarter (Minimum of 5%)	CP4-ES-2101	Protection of Human Health & Environment
			Field Parameter	NA			
MW293A	GW	MRGA	TCE (µg/L), Tc-99 (pCi/L), 1,1-DCE (µg/L)	Low	1/Quarter (Minimum of 5%)	CP4-ES-2101	Protection of Human Health & Environment
			Field Parameter	NA			
MW155	GW	LRGA	TCE (µg/L), Tc-99 (pCi/L), 1,1-DCE (µg/L)	High	1/Quarter (Minimum of 5%)	CP4-ES-2101	Notification for Institution of Corrective Measures
			Field Parameter	NA			
MW156	GW	URGA	TCE (µg/L), Tc-99 (pCi/L), 1,1-DCE (µg/L)	High	1/Quarter (Minimum of 5%)	CP4-ES-2101	Notification for Institution of Corrective Measures
			Field Parameter	NA			
MW341	GW	MRGA	TCE (µg/L), Tc-99 (pCi/L), 1,1-DCE (µg/L)	High	1/Quarter (Minimum of 5%)	CP4-ES-2101	Notification for Institution of Corrective Measures
			Field Parameter	NA			

^a Refer to RAWP Tables 3 & 4, and Figures 4, 5, 6, & 7 for more detail.

^b See Analytical SOP References Table (Worksheet #21).

^c Monthly average/daily maximum.

^d VOC and Rad concentration levels referenced from MOA.

^e Transect well location.

^f Proposed new well location.

**QAPP Worksheet #19.
Analytical SOP Requirements Table**

Matrix	Analytical Group	Concentration Level	Analytical and Preparation Method/SOP Reference *	Sample Volume	Containers (number, size, and type)	Preservation Requirements (chemical, temperature, light protected)	Maximum Holding Time (preparation/analysis)
Water	VOC	Low	624/8260B	120 mL	3 x 40 mL Glass VOA Vial with Teflon septum cap	HCl; pH < 2, cool to < 4°C, no headspace Clear or amber glass	14 days for preserved
Water	RADs	Low	liquid Scintillation	3 liters	3 x 1 liter Plastic	HNO ₃ pH < 2, Cool to < 4°C ^a	6 months

NOTE: Sample volume and container requirements will be specified by the laboratory. This table includes standard requirements for routine analytical groups.

*See Analytical SOP References table (Worksheet #23). The current version of procedures is accessible for reference on FPDP external Web site at the following link: [http://www.ffspaducah.com/public-documents/NE Plume Optimization Procedures/NE Plume Optimization Procedures.zip](http://www.ffspaducah.com/public-documents/NE%20Plume%20Optimization%20Procedures/NE%20Plume%20Optimization%20Procedures.zip).

^a Check with specific laboratory conducting analyses to ensure that acidification will not interfere with laboratory procedures.

D-43

HCl = hydrochloric acid
HNO₃ = nitric acid
RAD = radionuclide

Title: QAPP for Northeast Plume Optimization Project, Paducah Gaseous Diffusion Plant
Revision Number: 0
Revision Date: 4/2016

**QAPP Worksheet #30.
Analytical Services Table**

Matrix	Analytical Group	Concentration Level	Sample Locations/ID Numbers	Analytical SOP*	Data Package Turnaround Time	Laboratory/Organization** (Name and Address, Contact Person and Telephone Number)	Backup Laboratory/Organization** (Name and Address, Contact Person and Telephone Number)
Water	Radionuclides	See Worksheet #18	See Worksheet #18	See Worksheet #23	28-day	TBD	TBD
Water	VOCs	See Worksheet #18		See Worksheet #23	28-day		

*Analytical method SOPs for radiochemistry parameters are laboratory specific.

** The laboratory is responsible for maintaining instrument and equipment maintenance, testing, and inspection information per their QA Plan. This information is audited annually by DOECAP. Laboratory(s) contracted will be DOECAP audited.

ID = identification

Title: QAPP for Northeast Plume Optimization Project, Paducah Gaseous Diffusion Plant
Revision Number: 0
Revision Date: 4/2016

**QAPP Worksheet #20.
Field Quality Control Sample Summary Table**

Matrix	Analytical Group	Concentration Level	Analytical and Preparation SOP Reference	No. of Sampling Locations	No. of Field Duplicate Pairs	Inorganic	No. of Field Blanks	No. of Equip. Blanks	Total No. of Samples to Lab
						No. of MS			
Water (Groundwater and Surface Water)	VOCs	Low	See Worksheet #12-K	See Worksheet #18	5%	5%	5%	5%	See Worksheet #18
Water (Groundwater and Surface Water)	Radionuclides	Low	See Worksheet #12-Q	See Worksheet #18	5%	5%	5%	5%	See Worksheet #18

MS = matrix spike

**QAPP Worksheet #21.
Project Sampling SOP References Table**

Site-specific SOPs have been developed for site sampling and data management activities.

Reference Number	Title and Number^a	Originating Organization^b	Equipment Type	Modified for Project Work? (Y/N)	Comments
1	CP4-ES-0043, <i>Temperature Control for Sample Storage</i>	Contractor	Sampling	N	N/A
2	CP4-ES-1001, <i>Transmitting Data to the Paducah Oak Ridge Environmental Information System (OREIS)</i>	Contractor	N/A	N	N/A
3	CP4-ES-2100, <i>Groundwater Level Measurement</i>	Contractor	Sampling	N	N/A
4	CP4-ES-2101, <i>Groundwater Sampling</i>	Contractor	Sampling	N	N/A
5	CP4-ES-2203, <i>Surface Water Sampling</i>	Contractor	Sampling	N	N/A
6	CP4-ES-0074, <i>Monitoring Well Inspection and Maintenance</i>	Contractor	Sampling	N	N/A
7	CP4-ES-2700, <i>Logbooks and Data Forms</i>	Contractor	N/A	N	N/A
8	CP4-ES-2702, <i>Decontamination of Sampling Equipment and Devices</i>	Contractor	Sampling	N	N/A
9	CP4-ES-2704, <i>Trip, Equipment, and Field Blank Preparation</i>	Contractor	Sampling	N	N/A
10	CP4-ES-2708, <i>Chain-of-Custody Forms, Field Sample Logs, Sample Labels, and Custody Seals</i>	Contractor	Sampling	N	N/A

QAPP Worksheet #21. (Continued)
Project Sampling SOP References Table

Reference Number	Title and Number ^a	Originating Organization ^{b, c}	Equipment Type	Modified for Project Work? (Y/N)	Comments
11	CP3-ES-5003, <i>Quality Assured Data</i>	Contractor	N/A	N	N/A
12	CP3-ES-5004, <i>Sample Tracking, Lab Coordination, and Sample Handling</i>	Contractor	Sampling	N	N/A
13	CP3-ES-5007, <i>Data Management Coordination</i>	Contractor	N/A	N	N/A
14	CP2-ES-5102, <i>Radiochemical Analyses Data Verification and Validation</i>	Contractor	N/A	N	N/A
15	CP2-ES-5105, <i>Volatile and Semivolatile Analyses Data Verification and Validation</i>	Contractor	N/A	N	N/A
16	CP3-ES-1003, <i>Developing, Implementing, and Maintaining Data Management Implementation Plans</i>	Contractor	N/A	N	N/A
17	CP4-ES-1002, <i>Submitting, Reviewing, and Dispositioning Changes to the Environmental Databases OREIS and PEMS</i>	Contractor	N/A	N	N/A
18	CP3-OP-0009, <i>Performance Observations</i>	Contractor	N/A	N	N/A
19	DOE/LX/07-1280&D2/R2 <i>Remedial Action Work Plan for Optimization of the Northeast Plume Interim Remedial Action at the Paducah Gaseous Diffusion Plant, Paducah, Kentucky, Section 7, "Waste Management Plan"</i>	Contractor	N/A	N	N/A
20	CP4-ES-2303, <i>Borehole Logging</i>	Contractor	N/A	N	N/A
21	CP4-ES-0069, <i>Monitoring Well and Associated Infrastructure Installation</i>	Contractor	N/A	N	N/A
22	CP4-ES-2100/R0, <i>Groundwater Level Measurement</i>	Contractor	Sampling	N	N/A
23	CP3-ES-5004, <i>Sample Tracking Lab Coordinator and Sample Handling</i>	Contractor	Sampling	N	N/A

^a The current version of procedures is accessible for reference on FPDP external Web site at the following link: [http://www.ffspaducah.com/public-documents/NE Plume Optimization Procedures/NE Plume Optimization Procedures.zip](http://www.ffspaducah.com/public-documents/NE%20Plume%20Optimization%20Procedures/NE%20Plume%20Optimization%20Procedures.zip).

^b The work will be conducted by FPDP staff or a subcontractor. In either case, SOPs listed will be followed.

^c Note: This project will not utilize any on-site laboratory analytical facilities.

QAPP Worksheet #22.
Field Equipment Calibration, Maintenance, Testing, and Inspection Table

Field Equipment*	Calibration Activity	Maintenance Activity	Testing Activity	Inspection Activity	Frequency	Acceptance Criteria	Corrective Action	Responsible Person	SOP Reference
Water Quality Meter	Calibration check at the beginning of the day	Performed monthly and as needed	Measure solutions with known values (National Institute for Standards and Technology traceable buffers and conductivity calibration solutions)	Upon receipt, successful operation	Daily before each use	Per manufacturer's specifications	Recalibrate or service as necessary	Field Team Leader	Manufacturer's specifications
Colorimeter (for total residual chlorine)	Accuracy check at the beginning of each day's use	As needed	Measure with standard solution	Upon receipt, successful operation	Check daily before each use	Within range of manufacturer's standard	Service by manufacturer or replace	Field Team Leader	Manufacturer's specifications
Titration (for total residual chlorine)	Accuracy check at the beginning of each day	As needed	Measure with standard solution	Upon receipt, successful operation	Check daily before each use	With range of manufacturer's standard	Service by manufacturer or replace	Field Team Leader	Manufacturer's specifications
Electronic Water Level Meter	Accuracy check annually against a steel tape	Replace as needed	Annual verification	Upon receipt, successful operation	Check daily before each use	Pass/Fail	Service by manufacturer or replace	Field Team Leader	Manufacturer's specifications
Hach flow meter	Calibrate to readings on flume	Quarterly and as needed	Measure against flume	Upon receipt, successful operation	Weekly as needed	Pass/Fail	Service by manufacturer or replace	Field Team Leader	Manufacturer's specifications

*Field survey/sampling instrumentation will be maintained, tested, and inspected according to manufacturer's instructions.

**QAPP Worksheet #23.
Analytical SOP References Table**

Reference Number*	Title, Revision Date, and/or Number	Definitive or Screening Data	Analytical Group	Instrument	Organization Performing Analysis**	Modified for Project Work? (Y/N)
SW-846-8260	VOCx by Gas Chromatography/Mass Spectrometry (GC/MS)	Definitive	VOAs	GC/MS	GEL Laboratories	N
EPA-624	Purgeables	Definitive	VOAs	GC/MS	GEL Laboratories	N
EPA-160.2	Residue, Non-Filterable (Gravimetric, Dried at 103-105°C)	Definitive	Miscellaneous (Total Suspended Solids)	Per SOP	GEL Laboratories	N
SM 2540 D	Total Suspended Solids Dried at 103–105°C	Definitive	Miscellaneous (Total Suspended Solids)	Per SOP	GEL Laboratories	N
EPA-1664 A	N-Hexane Extractable Material (HEM; Oil and Grease) and Silica Gel Treated N-Hexane Extractable Material (SGT-HEM; Non-polar Material) by Extraction and Gravimetry	Definitive	Miscellaneous (Oil and Grease)	Per SOP	GEL Laboratories	N
Gas Flow Proportional	Gross Alpha and Beta Activity	Definitive	Radionuclides	Gas flow proportional counter	GEL Laboratories	N
Liquid Scintillation	Tc-99 by Liquid Scintillation	Definitive	Radionuclides (Tc-99)	Liquid Scintillation	GEL Laboratories	N

*Information will be based on laboratory used.

**The laboratory is responsible for maintaining instrument and equipment maintenance, testing, and inspection information per their QA Plan. This information is audited annually by DOECAP. Laboratory(s) contracted will be DOECAP audited.

QAPP Worksheet #24.
Analytical Instrument Calibration Information

All laboratory equipment and instruments used for quantitative measurements are calibrated in accordance with the laboratory's formal calibration program. Whenever possible, the laboratory uses recognized procedures for calibration such as those published by EPA or American Society for Testing and Materials. If established procedures are not available, the laboratory develops a calibration procedure based on the type of equipment, stability, characteristics of the equipment, required accuracy, and the effect of operation error on the quantities measured. Whenever possible, physical reference standards associated with periodic calibrations, such as weights or certified thermometers with known relationships to nationally recognized standards, are used. Where national reference standards are not available, the basis for the reference standard is documented. Equipment or instruments that fail calibration or become inoperable during use are tagged to indicate they are out of calibration. Such instruments or equipment is repaired and successfully recalibrated prior to reuse. All high resolution mass spectrometer instruments undergo extensive tuning and calibration prior to running each sample set. The calibrations and ongoing instrument performance parameters are recorded and reported as part of the analytical data package.

The laboratory is responsible for maintaining instrument calibration information per their QA Plan, including control charts established for all instrumentation. This information is audited annually by DOECAP. Laboratory(s) contracted will be DOECAP audited.

QAPP Worksheet #25.
Analytical Instrument and Equipment Maintenance, Testing, and Inspection Table

Instrument/ Equipment	Maintenance Activity	Testing Activity	Inspection Activity	Frequency	Acceptance Criteria	Corrective Action	Responsible Person	SOP Reference*
GC-MS	Replace/clean ion source; clean injector, replace injector liner, replace/clip capillary column, flush/replace tubing on purge and trap; replace trap	QC standards	Ion source, injector liner, column, column flow, purge lines, purge flow, trap	As needed	Must meet initial and/or continuing calibration criteria	Repeat maintenance activity or remove from service	Laboratory Section Manager	See Worksheet #23
GC	ECD maintenance; replace/clip capillary column	QC standards	ECD, FID, injector, injector liner, column, column flow	As needed	Must meet initial and/or continuing calibration criteria	Repeat maintenance activity or remove from service	Laboratory Section Manager	See Worksheet #23
pH meter	Clean probe	QC standards	Probe	As needed	The value for each of the certified buffer solutions must be within ± 0.05 pH units of the expected value	Repeat maintenance activity or remove from service	Laboratory Manager	See Worksheet #22
Spectrophotometer	Flush/replace tubing	QC standards	Tubing	As needed	Must meet initial and/or continuing calibration criteria	Repeat maintenance activity of remove from service	Laboratory Manager	See Worksheet #23

*The laboratory is responsible for maintaining instrument and equipment maintenance, testing, and inspection information per their QA Plan. This information is audited annually by DOECAP. Laboratory(s) contracted will be DOECAP audited. Field survey/sampling instrumentation will be maintained, tested, and inspected according to manufacturer's instructions.

ECD = electron capture detector; FID = flame ionization detector; GC = gas chromatography; GC-MS = gas chromatography mass spectrometer

**QAPP Worksheet #26.
Sample Handling System**

SAMPLE COLLECTION, PACKAGING, AND SHIPMENT	
Sample Collection (Personnel/Organization):	Sampling Teams/DOE Prime Contractor and Subcontractors
Sample Packaging (Personnel/Organization):	Sampling Teams/DOE Prime Contractor and Subcontractors
Coordination of Shipment (Personnel/Organization):	Lab Coordinator/DOE Prime Contractor
Type of Shipment/Carrier:	Direct Delivery or Overnight/Federal Express or United Parcel Service
SAMPLE RECEIPT AND ANALYSIS	
Sample Receipt (Personnel/Organization):	Sample Management/Contracted Laboratory
Sample Custody and Storage (Personnel/Organization):	Sample Management/Contracted Laboratory
Sample Preparation (Personnel/Organization):	Analysts/Contracted Laboratory
Sample Determinative Analysis (Personnel/Organization):	Analysts/Contracted Laboratory
SAMPLE ARCHIVING	
Field Sample Storage (No. of days from sample collection):	The fixed-base laboratory will archive samples for 4 months or less
Sample Extract/Digestate Storage (No. of days from extraction/digestion):	120 Days
Biological Sample Storage (No. of days from sample collection):	Not applicable.
SAMPLE DISPOSAL	
Personnel/Organization:	Waste Disposition/Sample Management Office/DOE Prime Contractor and Subcontractors
Number of Days from Analysis:	6 months

**QAPP Worksheet #27.
Sample Custody Requirements***

Chain-of-custody procedures are comprised of maintaining sample custody and documentation of samples for evidence. To document chain-of-custody, an accurate record of samples must be maintained in order to trace the possession of each sample from the time of collection to its introduction to the laboratory.

Field Sample Custody Procedures (sample collection, packaging, shipment, and delivery to laboratory):

Field sample custody requirements will be per DOE Prime Contractor procedures CP4-ES-2708, *Chain-of-Custody Forms, Field Sample Logs, Sample Labels, and Custody Seals*; and CP3-ES-5004, *Sample Tracking, Lab Coordination, and Sample Handling*.

Laboratory Sample Custody Procedures (receipt of samples, archiving, disposal):

These follow the DOECAP-audited laboratory's standard procedures. When the samples are delivered to the laboratory, signatures of the laboratory personnel receiving them and the courier personnel relinquishing them will be completed in the appropriate spaces on the chain-of-custody record, unless the courier is a commercial carrier. This will complete the sample transfer. It will be every laboratory's responsibility to maintain internal logbooks and records that provide custody throughout sample preparation and analysis process.

Sample Identification Procedures:

Sample identification requirements are specified in the Northeast Plume Optimization RAWP Section 9, "Data Management Implementation Plan."

Chain-of-custody Procedures:

Chain-of-custody requirements will be per DOE Prime Contractor procedures CP4-ES-2708, *Chain-of-Custody Forms, Field Sample Logs, Sample Labels, and Custody Seals*; and CP3-ES-5004, *Sample Tracking, Lab Coordination, and Sample Handling*.

*It is understood that SOPs are DOE Prime Contractor specific.

QAPP Worksheet #28.
QC Samples Table

Matrix: Water (Groundwater and Surface Water)						
Analytical Group/Concentration Level: VOC, Rad						
Sampling SOP: See Worksheet #21						
Analytical Method/SOP Reference: See Worksheet #23						
Sampler's Name/Field Sampling Organization: GEO Consultants						
Analytical Organization: Environmental Monitoring						
No. of Sample Locations: See Worksheet #18. Refer also to RAWP Tables 3 and 4.						
QC Sample	Frequency/Number*	Method/SOP QC Acceptance Limits	Corrective Action	Person(s) Responsible for Corrective Action	DQI	Measurement Performance Criteria
Field blank	Minimum 5%	≤ CRQL*	Verify results; reanalyze	Laboratory should alert project	Contamination—Accuracy/bias	See procedure CP3-ES-5003, <i>Quality Assured Data</i>
Trip blank	1 per cooler containing VOC samples	≤ CRQL*	Verify results; reanalyze		Contamination—Accuracy/bias	See procedure CP3-ES-5003, <i>Quality Assured Data</i>
Equipment blank	Minimum 5%	≤ CRQL*	Verify results; reanalyze		Contamination—Accuracy/bias	See procedure CP3-ES-5003, <i>Quality Assured Data</i>
Spiked field samples (MS and/or MSD)	1 per analytical batch	See data validation procedures CP2-ES-5102 and CP2-ES-5105	Check calculations and instrument; reanalyze affected samples	Laboratory should alert project	Accuracy/Precision	See procedure CP3-ES-5003, <i>Quality Assured Data</i>
Laboratory spiked blanks (LCS)	1 per analytical batch	See data validation procedures CP2-ES-5102 and CP2-ES-5105	Check calculations and instrument; reanalyze affected samples	Laboratory should alert project	Accuracy	See procedure CP3-ES-5003, <i>Quality Assured Data</i>

*CRQL = contract-required quantitation limit

**QAPP Worksheet #28. (Continued)
 QC Samples Table**

Matrix: Water (Groundwater and Surface Water)						
Analytical Group/Concentration Level: VOC, Rad						
Sampling SOP: See Worksheet #21						
Analytical Method/SOP Reference: See Worksheet #23						
Sampler's Name/Field Sampling Organization: GEO Consultants						
Analytical Organization: Environmental Monitoring						
No. of Sample Locations: See Worksheet #18. Refer also to RAWP Tables 3 and 4.						
QC Sample	Frequency/Number*	Method/SOP QC Acceptance Limits	Corrective Action	Person(s) Responsible for Corrective Action	DQI	Measurement Performance Criteria
Method blank	1 per analytical batch	See data validation procedures CP2-ES-5102 and CP2-ES-5105	Check calculations and instrument; reanalyze affected samples	Laboratory should alert project	Accuracy	See procedure CP3-ES-5003, <i>Quality Assured Data</i>
Surrogate standards	All samples, blanks, and QC samples	See data validation procedures CP2-ES-5102 and CP2-ES-5105	Check calculations and instrument; reanalyze affected samples	Laboratory should alert project	Accuracy	See procedure CP3-ES-5003, <i>Quality Assured Data</i>
Internal standards	All samples and standards	See data validation procedures CP2-ES-5102 and CP2-ES-5105	Check calculations and instrument; reanalyze affected samples	Laboratory should alert project	Accuracy	See procedure CP3-ES-5003, <i>Quality Assured Data</i>

QAPP Worksheet #28. (Continued)
QC Samples Table

Matrix: Water (Groundwater and Surface Water)
Analytical Group/Concentration Level: VOC, Rad
Sampling SOP: See Worksheet #21
Analytical Method/SOP Reference: See Worksheet #23
Sampler's Name/Field Sampling Organization: GEO Consultants
Analytical Organization: Environmental Monitoring
No. of Sample Locations: See Worksheet #18. Refer also to RAWP Tables 3 and 4.

QC Sample	Frequency/Number*	Method/SOP QC Acceptance Limits	Corrective Action	Person(s) Responsible for Corrective Action	DQI	Measurement Performance Criteria
Field duplicate	Minimum 5%	None	Data reviewer will place qualifiers on samples affected	Project	Homogeneity/ Precision	RPD ≤ 50% sediment, RPD < 25% aqueous
Laboratory duplicate	Per laboratory procedure	See data validation procedures CP2-ES-5102 and CP2-ES-5105	Verify results re-prepare and reanalyze	Laboratory analyst	Precision	See procedure CP3-ES-5003, <i>Quality Assured Data</i>
Tracers/Carriers	Each sample tested by a radiochemical separation method	See data validation procedure CP2-ES-5102	Check calculations and instrument; reanalyze affected samples	Laboratory analyst	Accuracy	See procedure CP3-ES-5003, <i>Quality Assured Data</i>

*The number of QC samples is listed on Worksheet #20.
**Unless dictated by project-specific parameters, ≤ CRQL.

**QAPP Worksheet #29.
Project Documents and Records Table**

All project data and information must be documented in a format that is usable by project personnel. The QAPP describes how project data and information shall be documented, tracked, and managed from generation in the field to final use and storage in a manner that ensures data integrity, defensibility, and retrieval.

Sample Collection Documents and Records	On-site Analysis Documents and Records	Off-site Analysis Documents and Records	Data Assessment Documents and Records*	Other
Data logbooks (electronic or paper) and associated completed sampling forms; sample chains-of-custody	Laboratory data packages, OREIS database, and associated data packages	OREIS database and associated data packages	CP3-ES-5003, Att. G, Data Assessment Review Checklist and Comment Form	CP3-OP-0009-F01, Observation Checklist Form

*It is understood that SOPs are DOE Prime Contractor specific.

**QAPP Worksheet #31.
Planned Project Assessments Table**

FPDP will ensure that protocol outlined in the QAPP is implemented adequately. Assessment activities help to ensure that the resultant data quality is adequate for its intended use and that appropriate responses are in place to address nonconformances and deviations from the QAPP. Below is a list of assessments project teams may use.

Assessment Type	Frequency	Internal or External	Organization Performing Assessment	Person(s) Responsible for Performing Assessment (Title and Organizational Affiliation)	Person(s) Responsible for Responding to Assessment Findings (Title and Organizational Affiliation)	Person(s) Responsible for Identifying and Implementing Corrective Actions (CA) (Title and Organizational Affiliation)	Person(s) Responsible for Monitoring Effectiveness of CA (Title and Organizational Affiliation)
Independent Assessment/ Surveillance	A	Internal	QA Manager or designee	QA Specialists	Project Manager	Project Manager	QA Manager
Laboratory Audit	Annual	External	DOECAP	Laboratory Assessor	Laboratory	Laboratory	DOECAP
Management Assessments	Annual	Internal	Project Manager or designee	Project Manager	Project Manager	Project Manager	QA Manager
Performance Observations	B	Internal	Project Manager or designee	Project Manager	Project Manager	Project Manager	Project Manager
Performance Observation Follow-up surveillances	Quarterly	Internal	Project Manager or designee	Project Manager or designee	Project Manager	Project Manager	Project Manager

D-58

A = assessment frequency determined by QA Manager and conducted per CP3-QA-1003, *Management and Self Assessments*.

B = assessment frequency determined by Project Manager.

*Reference: CP3-OP-0009, *Performance Observations Desk Instructions*.

**QAPP Worksheet #32.
 Assessment Findings and Corrective Action Responses***

All provisions shall be taken in the field and laboratory to ensure that any problems that may develop shall be dealt with as quickly as possible to ensure the continuity of the project/sampling events. Field modifications to procedures in the QAPP must be approved (by the FFA parties) before the modifications are implemented and then documented. The process controlling procedure modification is CP3-OP-0002, *Development, Approval, and Change Control for FPDP Performance Documents*. Field modifications are documented through the work control process per CP3-SM-1003. Corrective action in the field may be necessary when the sampling design is changed. For example, a change in the field may include increasing the number or type of samples or analyses, changing sampling locations, and/or modifying sampling protocol. When this occurs, the project team shall identify any suspected technical or QA deficiencies and note them in the field logbook. Worksheet #32 details how project teams will address assessment findings.

D-59

Assessment Type	Nature of Deficiencies Documentation	Individual(s) Notified of Findings (Name, Title, Organization)**	Time frame of Notification	Nature of Corrective Action Response Documentation	Individual(s) Receiving Corrective Action Response (Name, Title, Org.)	Time Frame for Response
Management, Independent, and Surveillances	Form CP3-QA-1003-F02, Management/Self-Assessment Report, Form CP3-QA-1003-F03, Management/Self-Assessment Checklist, and Form CP3-QA-3001-F02, Issue Identification Form	Project management, issue owner, contractor	Upon issuance of Forms CP3-QA-1003-F02, Management/Self-Assessment Report and CP3-QA-1003-F03, Management/Self-Assessment Checklist, form CP3-QA-3001-F02, Issue Identification Form, will be completed and attached to the assessment report	CP3-QA-3001, Issue Identification Form, documents the issue response and/or corrective actions	Action owner as designated by issue owner, contractor	Fifteen days for initial issue response, corrective action schedule determined by issue owner, per CP3-QA-3001

*It is understood that SOPs are DOE Prime Contractor specific.

**General project communications and those related to corrective actions are summarized on Worksheets #6, #31, and #33.

**QAPP Worksheet #33.
 QA Management Reports Table**

Reports to management include project status reports, field and/or laboratory audits, and data quality assessments. These reports will be directed to the QA Manager and Project Manager, who have ultimate responsibility for assuring that any corrective action response is completed, verified, and documented.

Type of Report*	Frequency (daily, weekly monthly, quarterly, annually, etc.)	Projected Delivery Date(s)	Person(s) Responsible for Report Preparation (Title and Organizational Affiliation)	Report Recipient(s) (Title and Organizational Affiliation)
Field Change Requests	As needed	Ongoing	Field staff	QAPP recipients
QAPP Addenda	As needed	Not Applicable	Project Manager	QAPP recipients
Field Audit Report	TBD by QA Manager	30 days after completion of audit	QA Manager	FPDP Project Manager QA Manager
Corrective Action Plan	As needed	Within 3 weeks of request	Project Manager	QA Manager

TBD = to be determined
 *Worksheet #31 and #32 summarize the nature and frequency of other QA assessments.

**QAPP Worksheet #34.
Verification (Step I) Process Table**

This section of the QAPP provides a description of the QA activities that will occur after the data collection phase of the project is completed. Implementation of this section will determine whether the data conforms to the specified criteria satisfying the project objectives.

Verification Input	Description ^a	Internal/ External	Responsible for Verification (Name, Organization)
Field Logbooks/Data Forms	Field logbooks are verified per DOE Prime Contractor procedure, CP4-ES-2700, <i>Logbooks and Data Forms</i> , and CP3-ES-5003, <i>Quality Assured Data</i> .	Internal	Project Management or designee, Contractor
Chains-of-Custody	Chains-of-custody are controlled by DOE Prime Contractor procedure, CP3-ES-5004, <i>Sample Tracking, Lab Coordination and Sample Handling</i> . Chains-of-custody will be included in data assessment packages for review as part of data verification and data assessment.	Internal	Sample Management Office Personnel, and Project Management, Contractor
Field and Laboratory Data	Field and analytical data are verified and assessed per DOE Prime Contractor procedure, CP3-ES-5003, <i>Quality Assured Data</i> . Data assessment packages will be created per this procedure. The data assessment packages will include field and analytical data, chains-of-custody, data verification and assessment queries, and other project-specific information needed for personnel to review the package adequately. Data assessment packages will be reviewed to document any issues pertaining to the data and to indicate if data met the data quality objectives of the project.	Internal	Sample Management Office Personnel, and Project Management, Contractor
Sampling Procedures	Evaluate whether sampling procedures were followed with respect to equipment and proper sampling support using audit and sampling reports, field change requests and field logbooks.	Internal	Sample Management Office Personnel, Project Management, and QA Personnel, ^b Contractor
Laboratory Data	All laboratory data will be verified by the laboratory performing the analysis for completeness and technical accuracy prior to submittal to FPDP. Subsequently, FPDP will evaluate the data packages for completeness and compliance.	External/ Internal	Laboratory Manager, FPDP Sample Management Office Personnel
Electronic Data Deliverables (EDDs)	Determine whether required fields and format were provided.	Internal	Sample Management Office Personnel
QAPP	All planning documents will be available to reviewers to allow reconciliation with planned activities and objectives.	Internal	All data users

^a It is understood that SOPs are DOE Prime Contractor specific.

^b QA specialist performs general QA review.

**QAPP Worksheet #35.
Assessment, Verification, and Validation (Steps IIa and IIb) Process Table**

Step IIa/IIb	Validation Input	Description^a	Responsible for Validation (Name, Organization)
IIa	Data Deliverables, Analytes, and Holding Times	The documentation from the contractual screening will be included in the data assessment packages, per DOE Prime Contractor procedure CP3-ES-5003, <i>Quality Assured Data</i> .	Sample Management Office Personnel, Contractor
IIa	Chain-of-Custody, Sample Handling, Sampling Methods and Procedures, and Field Transcription	These items will be validated during the data assessment process as required by DOE Prime Contractor procedure, CP3-ES-5003, <i>Quality Assured Data</i> , and CP3-ES-1003, <i>Developing, Implementing, and Maintaining Data Management Implementation Plans</i> . The documentation of this validation will be included in the data assessment packages.	Sample Management Office Personnel, Contractor
IIa	Analytical Methods and Procedures, Laboratory Data Qualifiers, and Standards	These items will be reviewed during the data validation process as required by DOE Prime Contractor data validation procedures. Data validation will be performed in parallel with data assessment. The data validation report and data validation qualifiers will be considered when the data assessment process is being finalized.	Data Validation Subcontractor, and Sample Management Office Personnel, Project, Contractor
IIa	Audits	The audit reports and accreditation and certification records for the laboratory supporting the projects will be considered in the bidding process.	QA Personnel
IIb	Deviations and qualifiers from Step IIa	Any deviations and qualifiers resulting from Step IIa process will be documented in the data assessment packages.	Sample Management Office Personnel, Project, and QA Personnel, Contractor
IIb	Sampling Plan, Sampling Procedures, Collocated Field Duplicates, Project Quantitation Limits, Confirmatory Analyses, Performance Criteria	These items will be evaluated as part of the data verification and data assessment process per DOE Prime Contractor procedure, CP3-ES-5003, <i>Quality Assured Data</i> . These items will be considered when evaluating whether the project met their Data Quality Objectives.	Sample Management Office Personnel, Project, and QA Personnel, Contractor

^a It is understood that SOPs are DOE Prime Contractor specific.

**QAPP Worksheet #36.
Validation (Steps IIa and IIb) Summary Table**

Step IIa/IIb	Matrix	Analytical Group	Concentration Level	Validation Criteria	Data Validator (title and organizational affiliation)
Step IIa/IIb	Water	All	All	National Functional Guidelines; Worksheets #12-K and #12-Q, #15-A, D, and K, and #28; and CP2-ES-5102 and CP2-ES-5105	Data Validator ^a

^a Validation is to be conducted by a qualified individual, independent from sampling, laboratory, project management, or other decision making personnel for the task. This could be an outside party or someone within FPDP who is not involved in the project.

**QAPP Worksheet #37.
Usability Assessment^{1,2}**

FPDP shall determine the adequacy of data based on the results of validation and verification. The usability step involves assessing whether the process execution and resulting data meet project quality objectives documented in the QAPP.

Summarize the usability assessment process and all procedures, including interim steps and any statistics, equations, and computer algorithms that will be used: Field and analytical data are verified and assessed per procedure CP3-ES-5003, *Quality Assured Data*. Data assessment packages will be created per this procedure. Data assessment packages will include field and analytical data, chains-of-custody, data verification and assessment queries, and other project-specific information needed for personnel to review the package adequately. Data assessment packages will be reviewed to document any issues pertaining to the data and to indicate if DQOs of the project were met. For data selected for validation, the following procedures are used: CP2-ES-5102 and CP2-ES-5105.

Describe the evaluative procedures used to assess overall measurement error associated with the project: PARCCS parameters (precision, accuracy, representativeness, comparability, completeness, and sensitivity) will be evaluated per procedure CP3-ES-5003, *Quality Assured Data*. This information will be included in the data assessment packages for review by project personnel. Data assessment also will include documentation of QC exceedances, trends, and/or bias in the data set. Data assessment will document any statistics used.

Identify the personnel responsible for performing the usability assessment: Project personnel, as verified by QA personnel.

Describe the documentation that will be generated during usability assessment and how usability assessment results will be presented so that they identify trends, relationships (correlations), and anomalies: Data assessment packages will be created, which will include data assessment comments/questions and laboratory comments. Data verification and assessment queries indicating any historical outliers will be included in the data assessment packages.

¹ It is understood that SOPs are DOE Prime Contractor specific.

² Additional usability assessment information can be referenced on Worksheets #11, #13, #14, and #16.